

G-01, 3.stk
M= 1:25

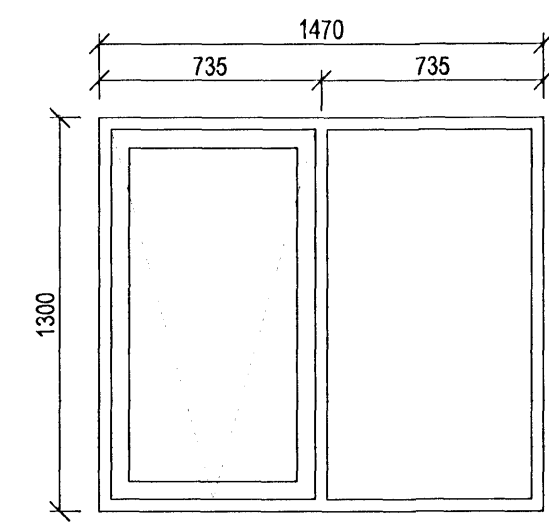

G-02, 3.stk
M= 1:25

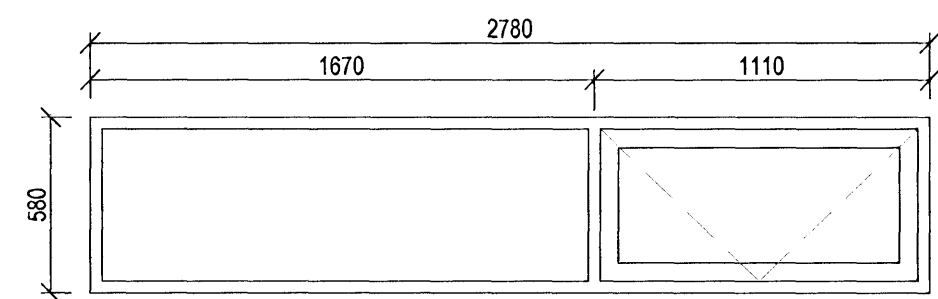

G-03, 1.stk
M= 1:25

GLUGGAR OG HURÐIR:

Gluggar eru timburgluggar / álkæddir timburgluggar, opnanleg fög úr Oregon pine eða sambærilegu. Allt gler er "K" gler.

Öll málmstykkj sem notuð eru í glugga og hurðir skulu vera með tæringarvörn / ryðfrí.

Einungis skal notast við CE merкта byggingarhluti.

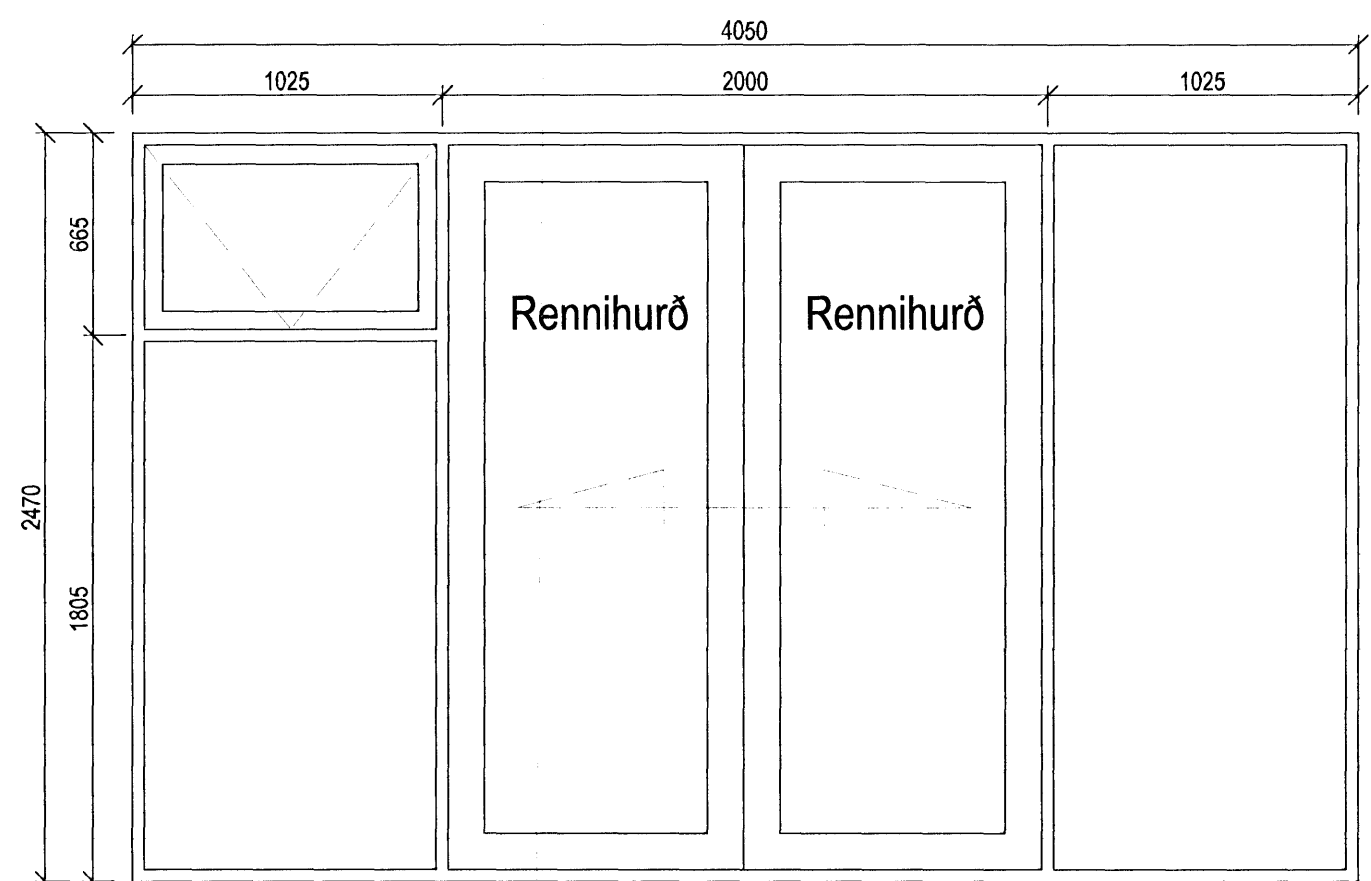

G-04, 1.stk
M= 1:25

Má skipta upp í 3. einingar

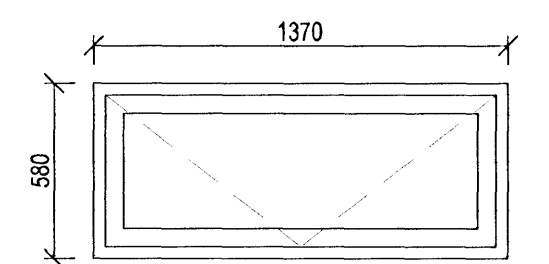

G-09, 1.stk
M= 1:25

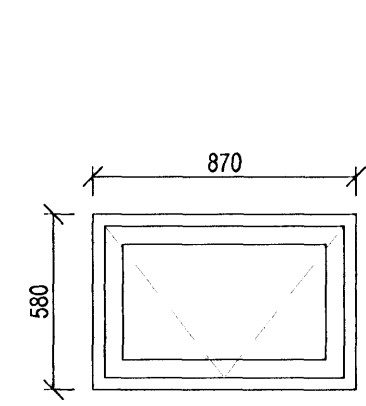

G-05, 1.stk
M= 1:25

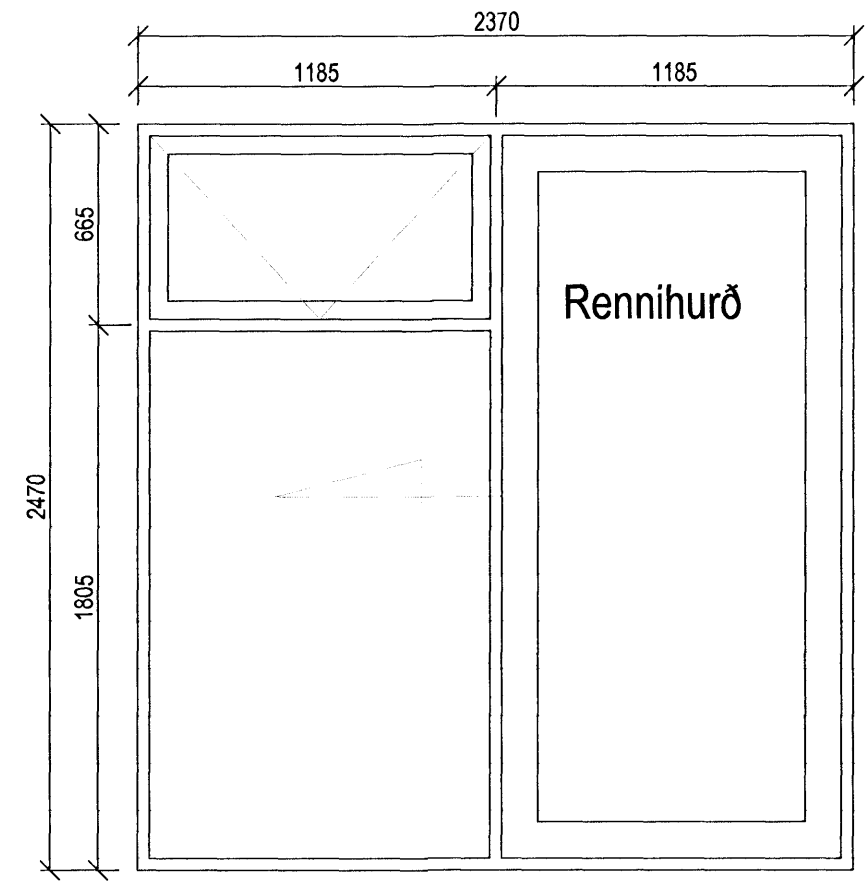

G-06, 1.stk
M= 1:25

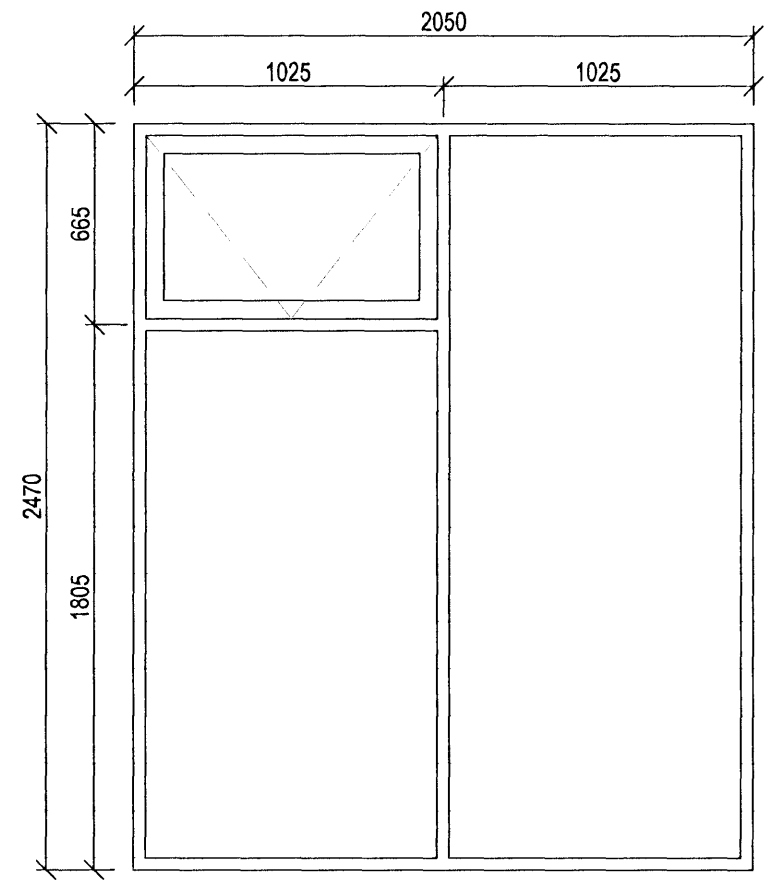

G-07, 1.stk
M= 1:25

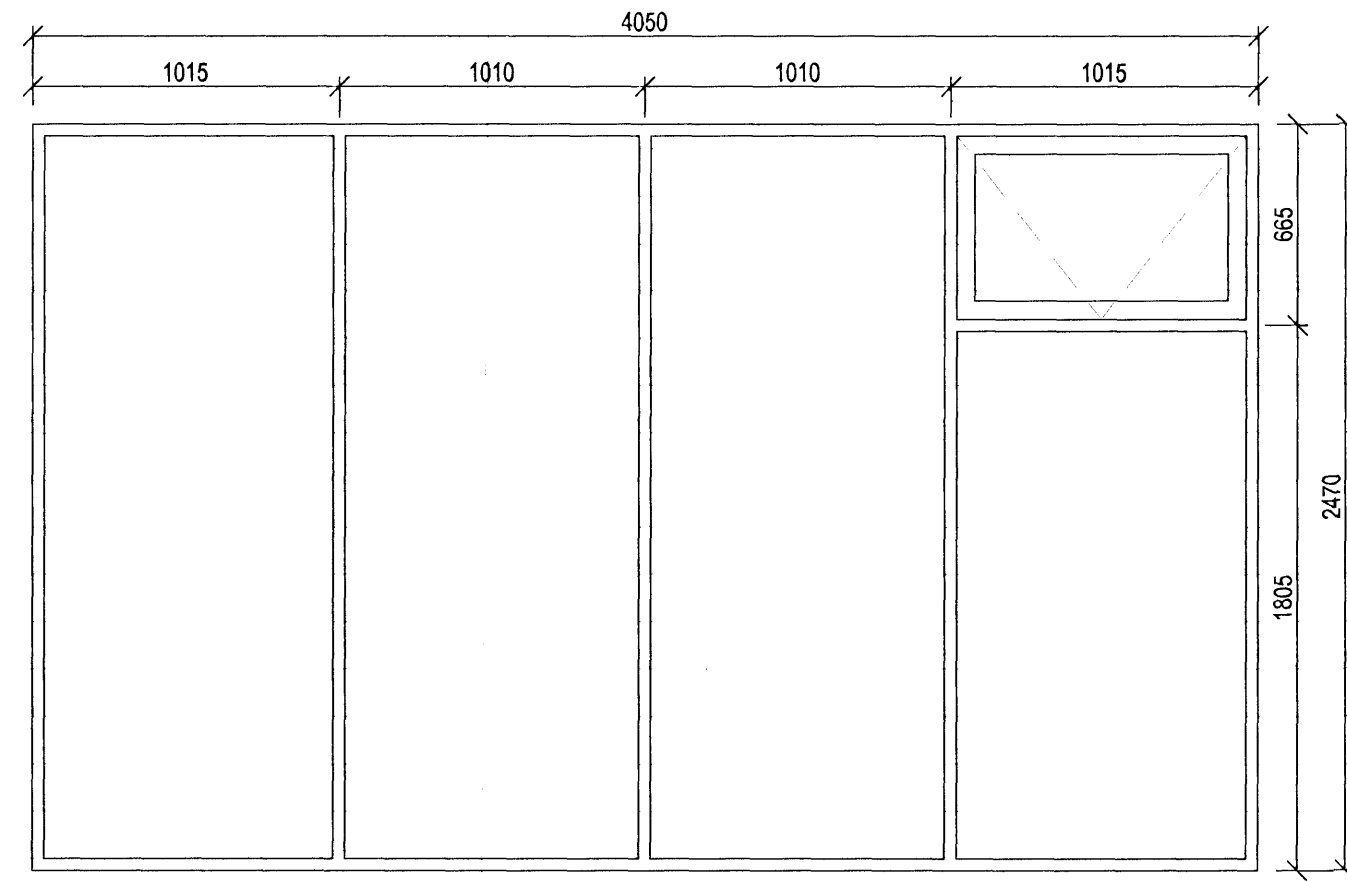

G-08, 1.stk
M= 1:25

Má skipta upp í 2. einingar

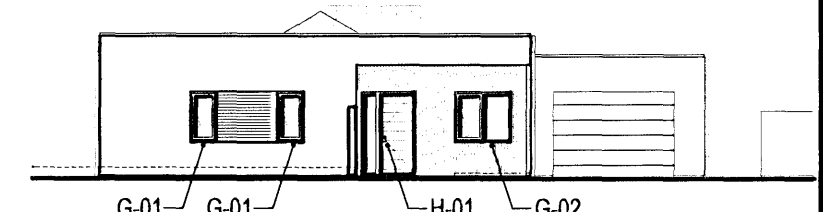

Norður
M= 1:200

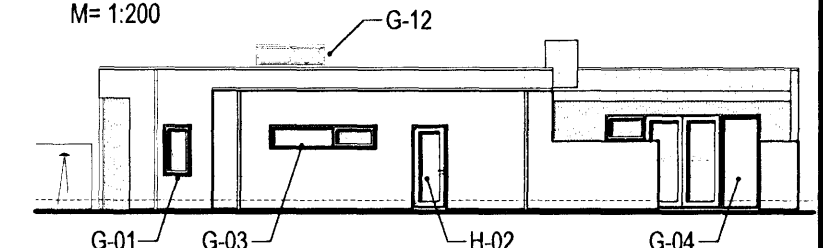

Vestur
M= 1:200

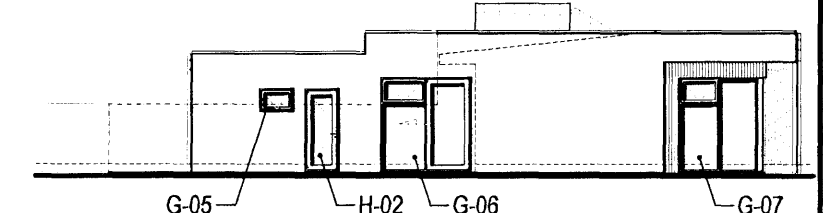

Suður
M= 1:200

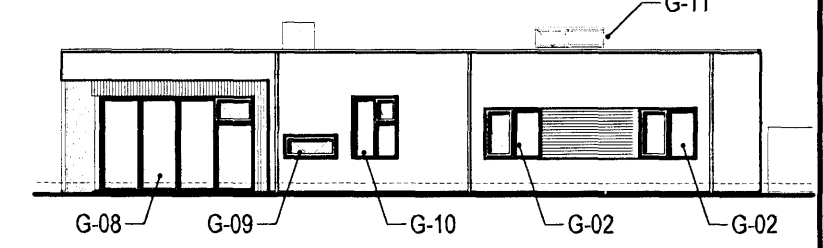

Austur
M= 1:200

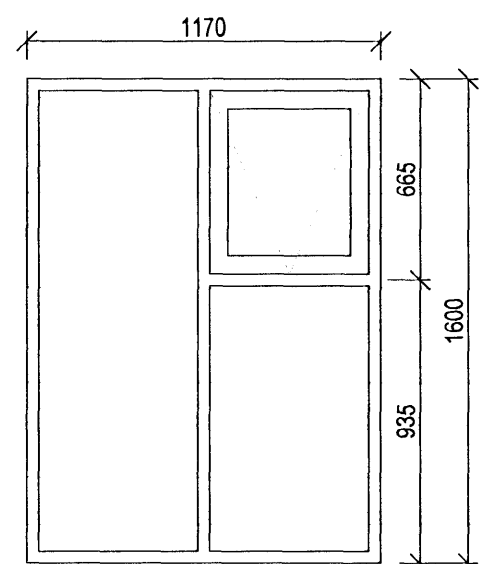

G-10, 1.stk
M= 1:25

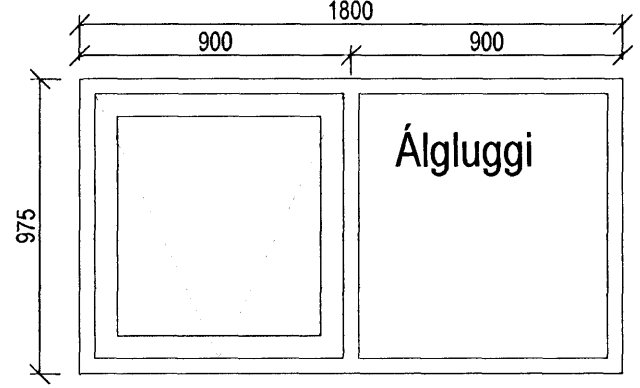

G-11, 1.stk
M= 1:25

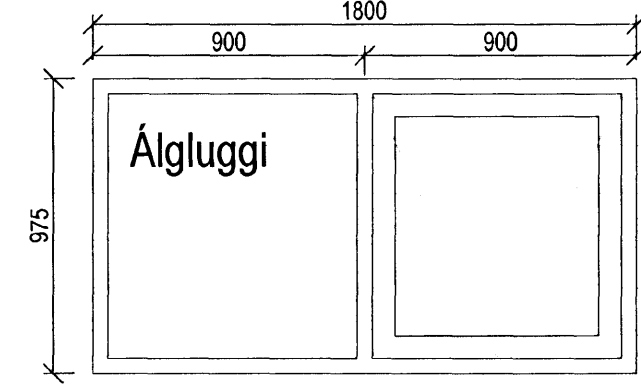

G-12, 1.stk
M= 1:25

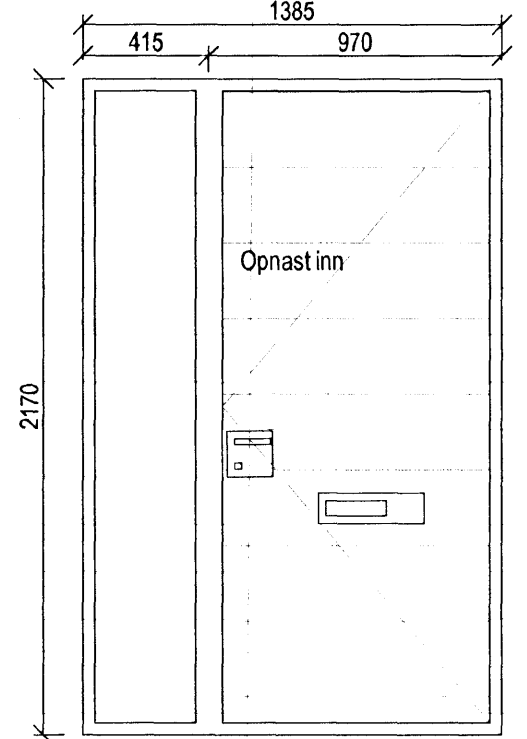

H-01, 1.stk
M= 1:25

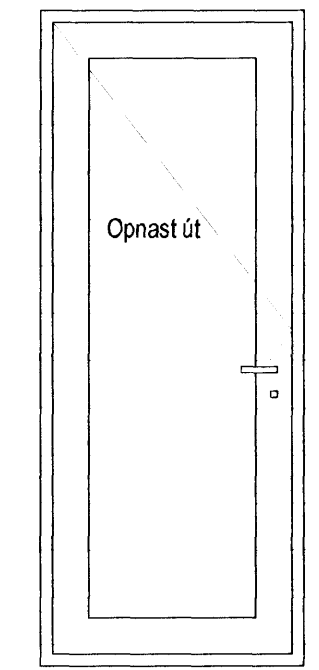

H-02, 2.stk
M= 1:25

<p>GLÓRA HÖNNUN RAÐGJÖF AETLANIR</p>	<p>Porleifur Björnsson 030673 3709 Byggingaræðingur BFI Gígjuvellir 1 230 RNIB Sími: 421 7562 693 4247 Póstfang: lei@glora.is</p>
<p>FLÉTTUVELLIR 15 221 HAFNARFJÖRÐUR</p>	<p>GLUGGAR OG HURÐATEIKNING</p>
<p>VERNR</p>	<p>VERNR</p>

Handwritten initials or signature.