

Samþykkt þann  
16 APR. 2008  
Byggingarvitlitrúnn í Hafnarfirði  
F.h. Hrólfur S. Gunnlaugsson

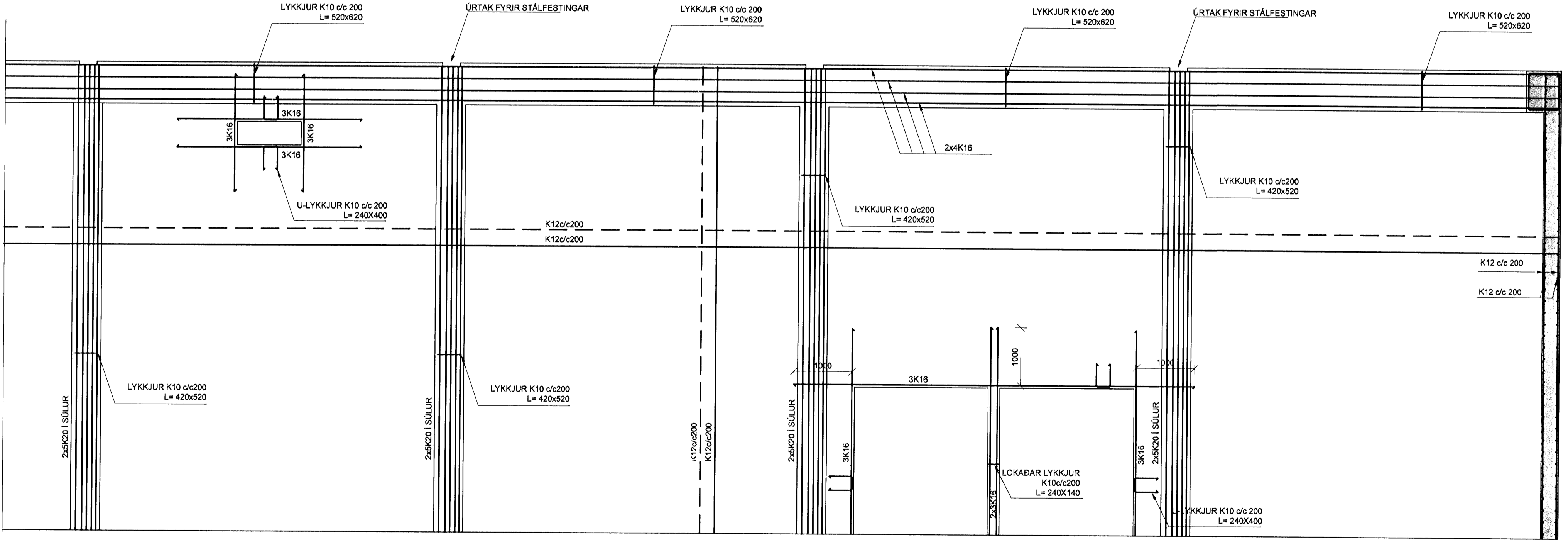

*Bj. Einar*  
Kt. 110457-2789

KAPLAKRIKI

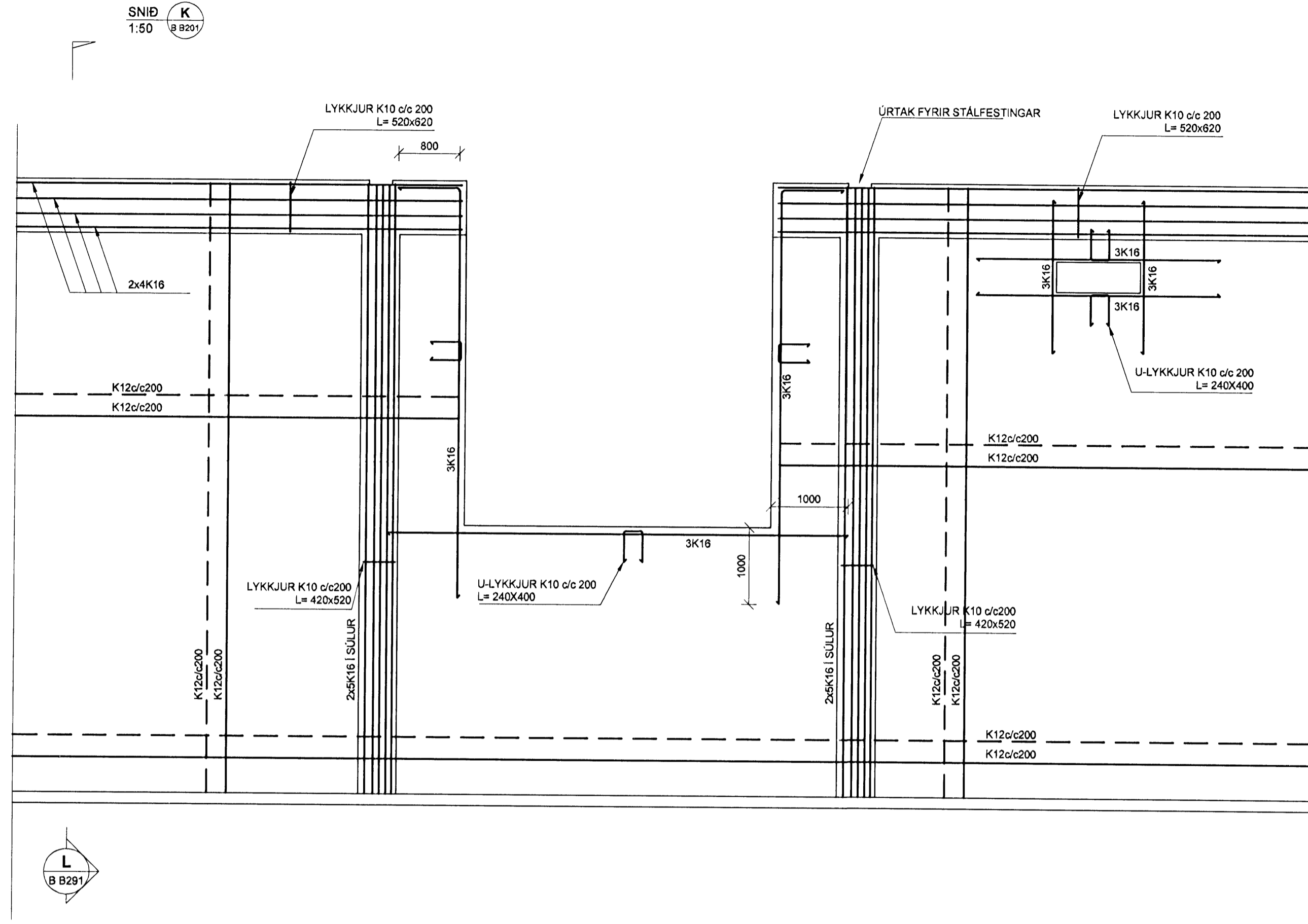
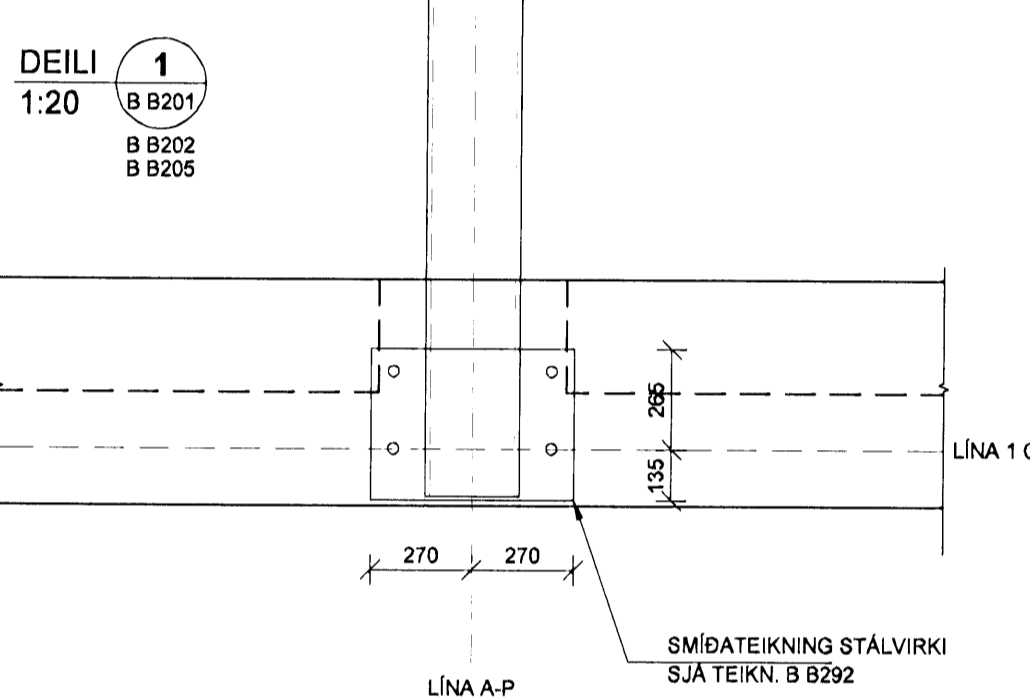
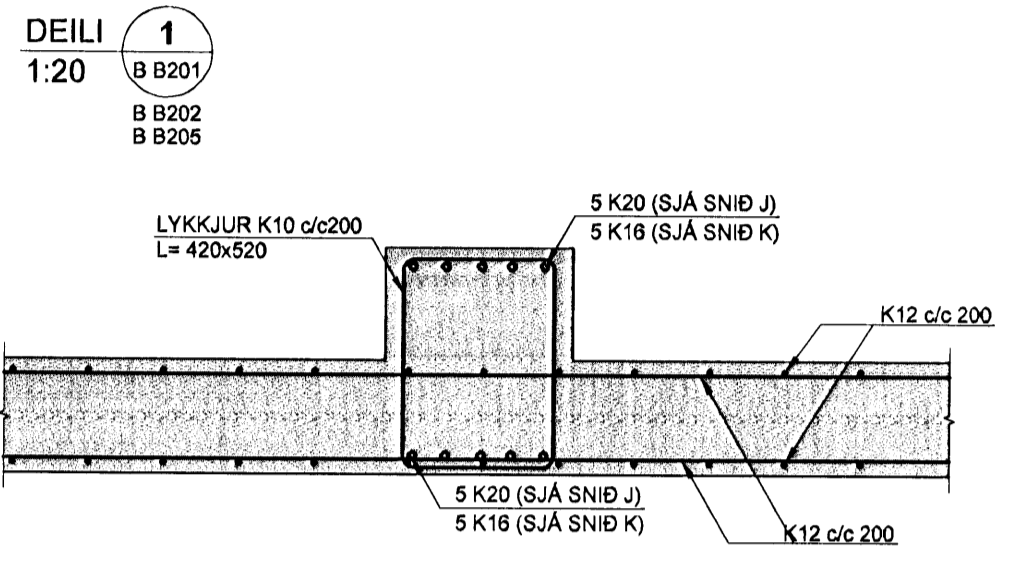
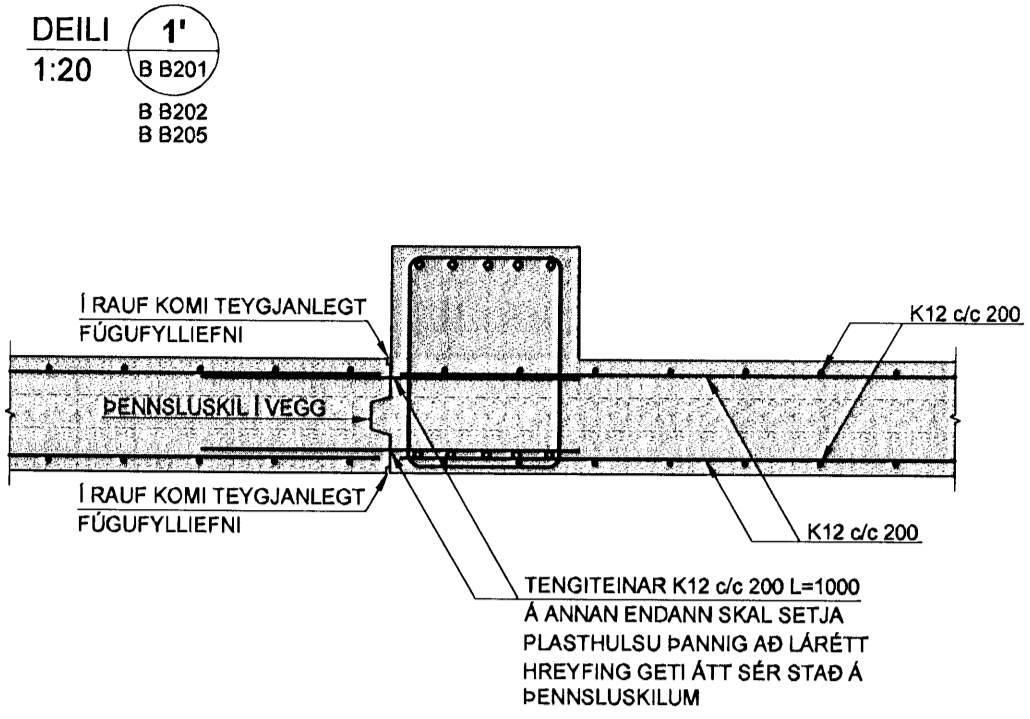
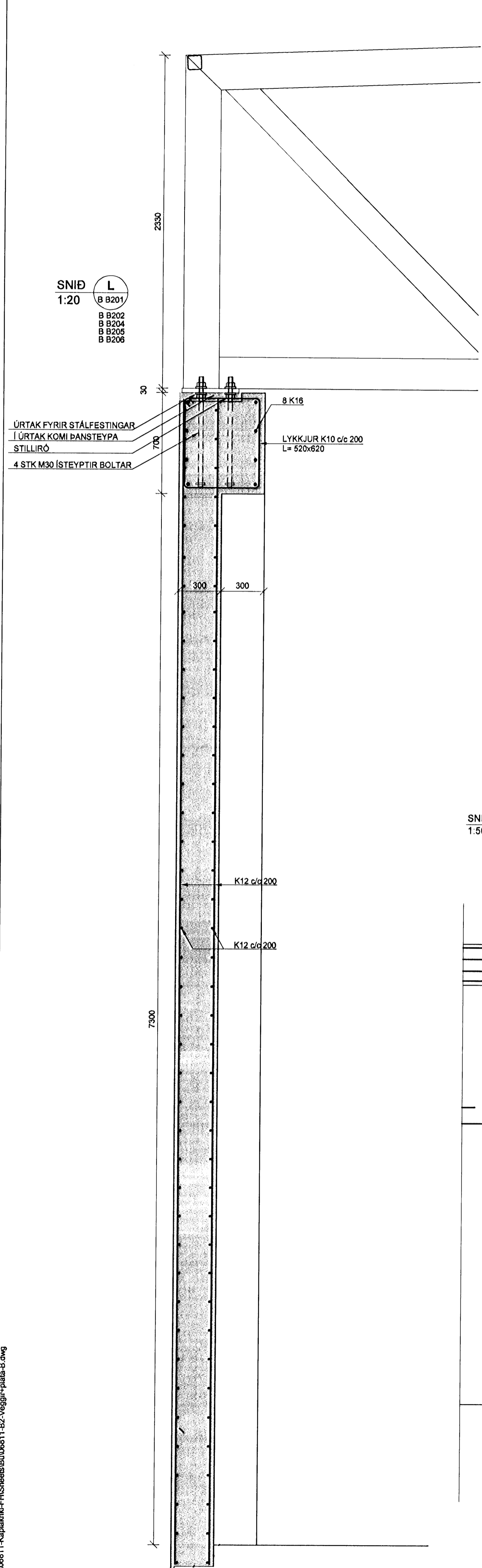
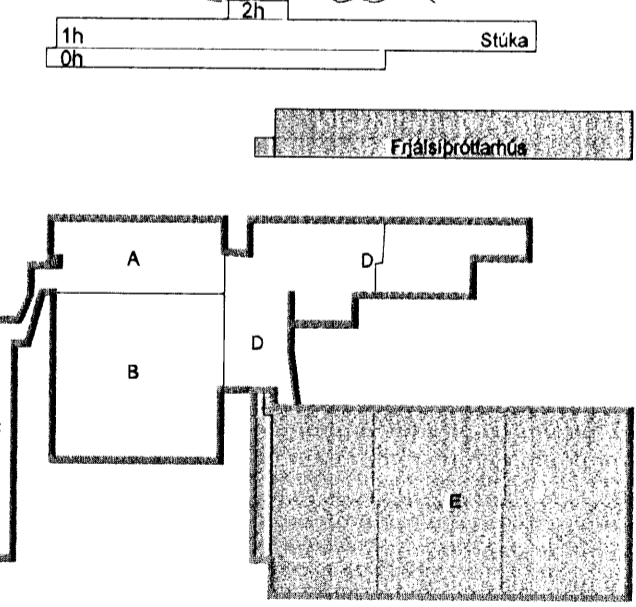

Útg. Dags. Skýring Hannað/Yfirfand

**VS**

VERKFRÆÐISTOFA

BÆJARHRAUN 20 · 220 HAFNARFJÖRÐUR · KENNIT. 710796-2899  
vsb@vsb.is · Sími 585 8600 · Fax 585 8610 · www.vsb.is

Aritun sérhönnuðar Björn Guðafsson Kt. 180550-4888				
Verkefni <b>KAPLAKRIKI HAFNARFIRÐI</b>				
Verkhúsi Búðarvirki Veggir og þakbitar frjálsþróttarhúss Snið og sérmýndir				
Hannað HOJ	Teiknað HOJ/BIB	Yfirfand BG	Kvarði 1:20 / 1:50	Síða / A1
Dags. 18.03.2008	Verkefni 06811	Teikning B B291	Útgáfa	-

V:\0306\06811\06811-KaplaKriki-FHShedab\06811\_02\_Veggir+Platan-B.dwg