

GRUNNMYND 1:50
Vatnslagnir efri hæð

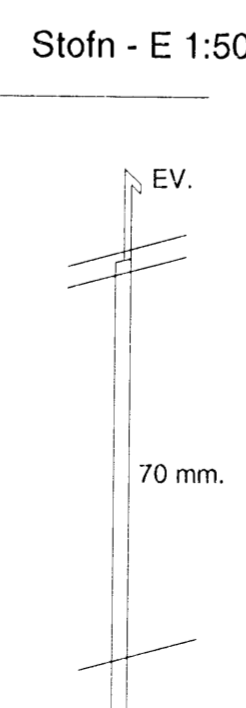

aðalhönnuður:
Kári Eiríksson - Arkitekt FAÍ - kt: 070365-4059

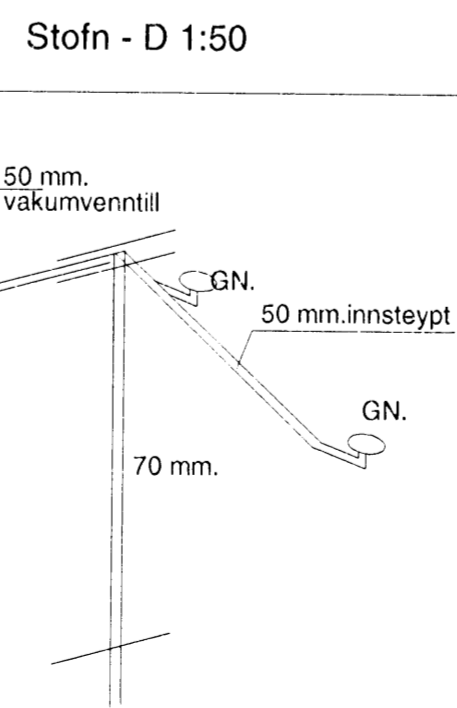
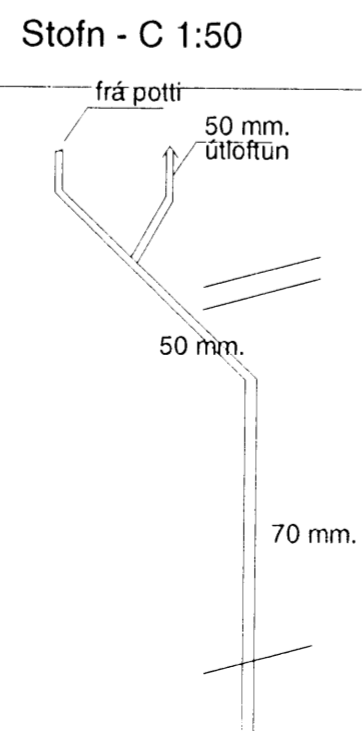
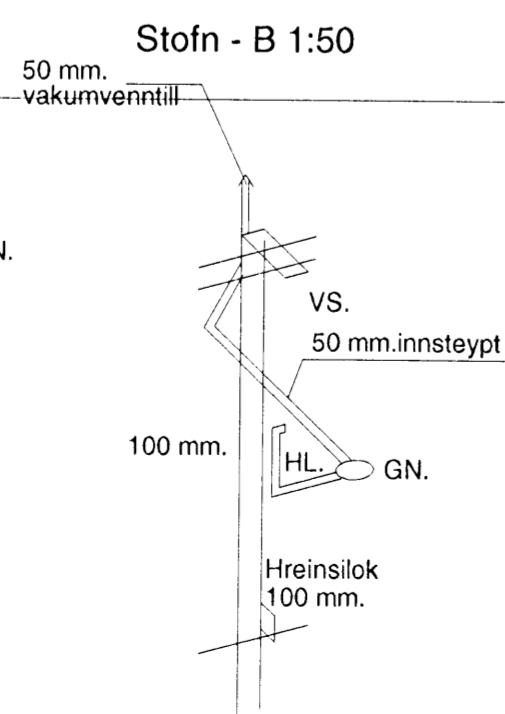
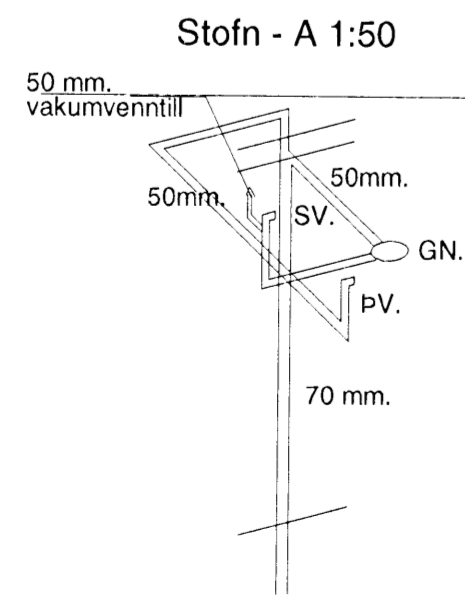
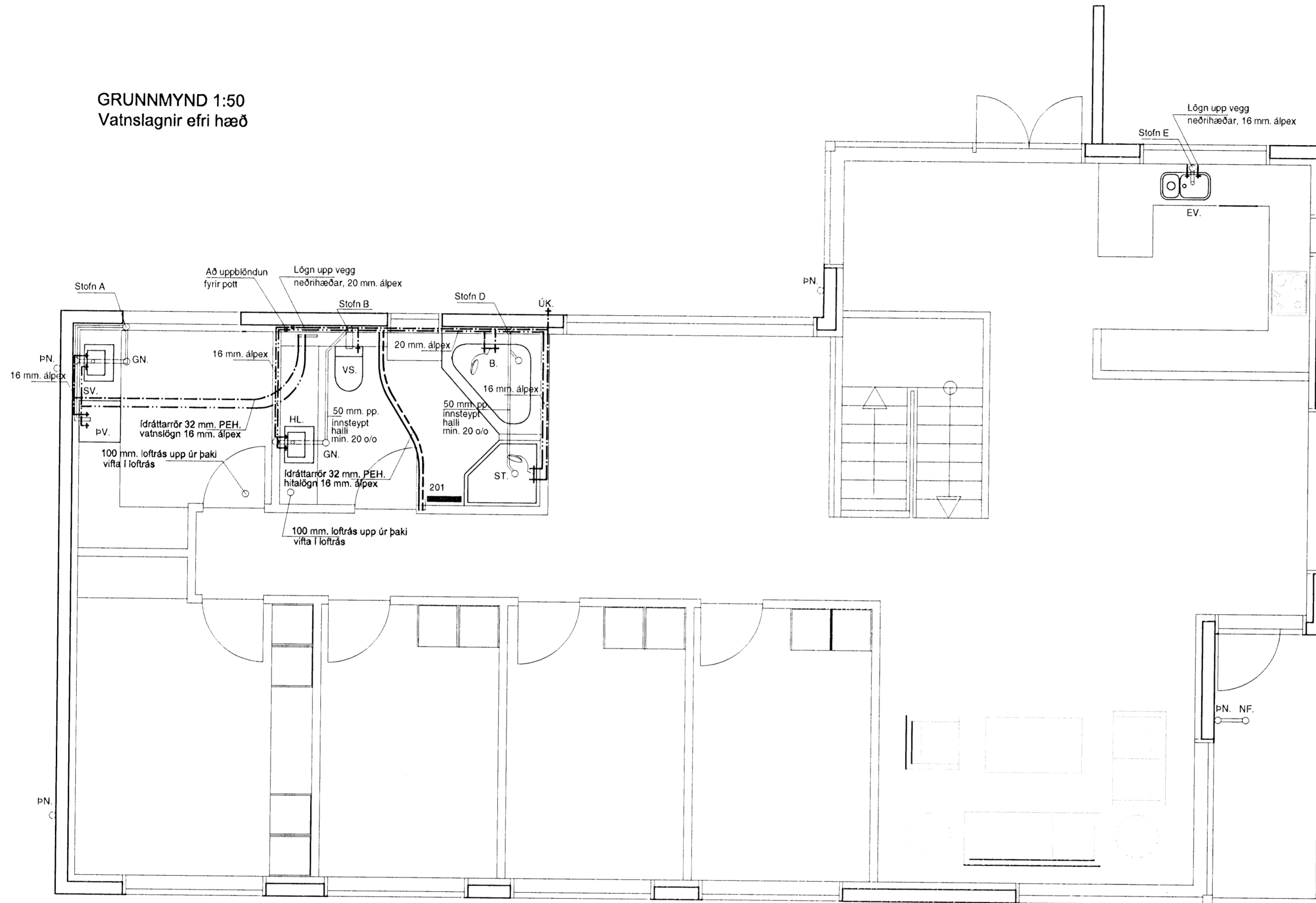
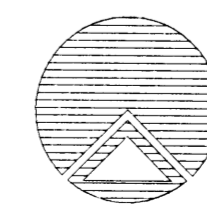

Teiknistofan Röðull

Hlíðarás 18 Hafnarfirði

Vatns og frárennslis. 2. hæð--frárennslisstofnar

Helgi Gunnarsson kt. 050350-4879 h.s. 5544708 gsm 6921020 nmt. 8533489
Jón Rafns Antonsson kt. 240347-2539 h.s. 5670775 gsm. 8928377 nmt. 8528377

Knarrarvogi 4 Reykjavík
S. 5683577 Fax 5683522

Mkv. 1:50	Hannað hg
Dags. sept. 2007	Teiknað hg
Breytt	Yfirfarið hg
Breytt	Þekkt bláða 14
Breytt	Bláð nr
Breytt	303