

ASK Arkitektar
14 FEB 2008
VBS

ÖLL MÁL ERU STÍF MÁL

GLUGGA-HURÐA GERÐ	STK
G 1a	46
G 1b	23
G 2a	11
G 2b	17
G 3a	10
G 3b	10
G 3c	12
G 3d	16
G 4a	28
G 4b	38
G 5	1
G 6	1
G 7	6
G 8a	6
G 8b	1
G 9a	6
G 9b	6
G 9c	6
G 10a	12
G 10b	3
G 11	6
G 12	1
G 13	6
G 14	1
G 15	1
G 16	15
G 17	3
G 18 stíghúsi 1.hæð	3
GLUGGAR SAMTALS	294
H 1 aðalinnangangur	3
H 2a sorpgeymsla	1
H 2b bílageymsla	1
H 3 hjólageymsla	3
H 4 sorpgeymsla (stutt)	1
H 5 salur	1
H 6 innri forstofa	2
H 7 innri forstofa	1
H 8 hurð í stíghúsi	15
H 9 bílageymsluhurð	1
HURÐIR SAMTALS	29

G 2b
Inn steypu

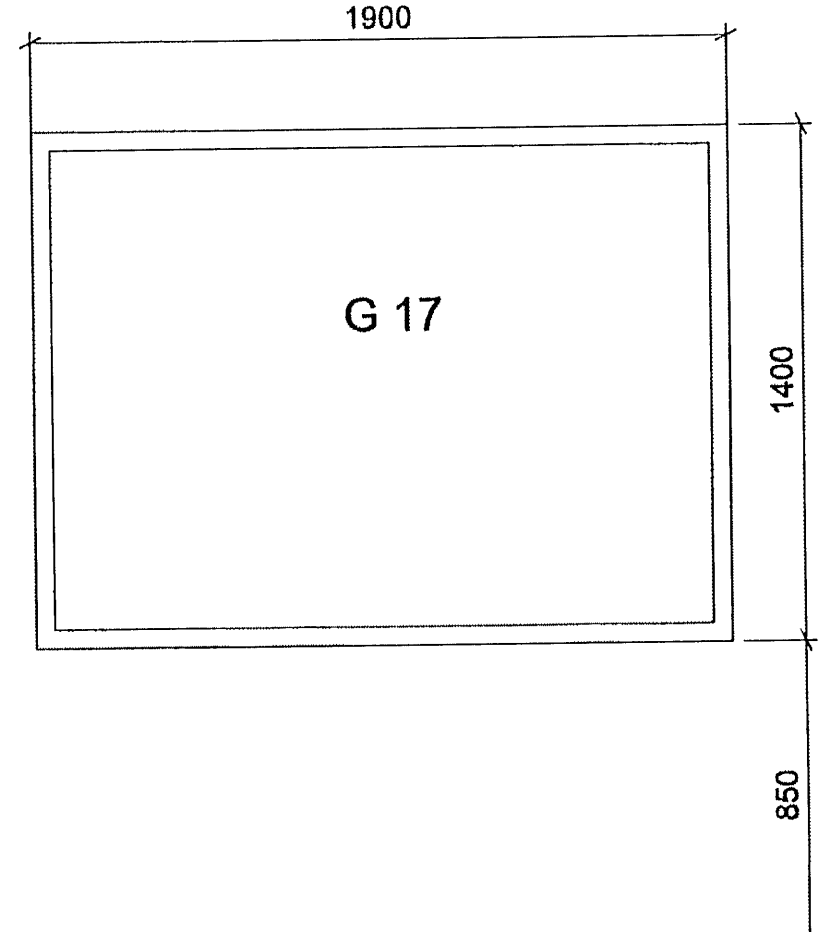
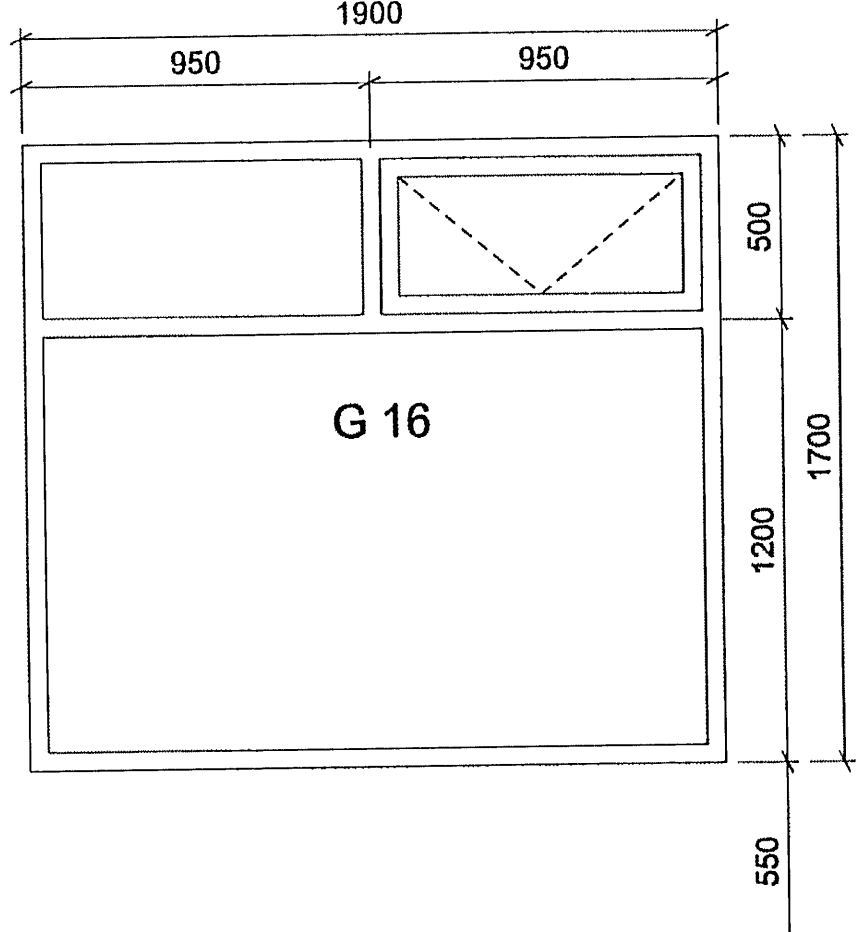
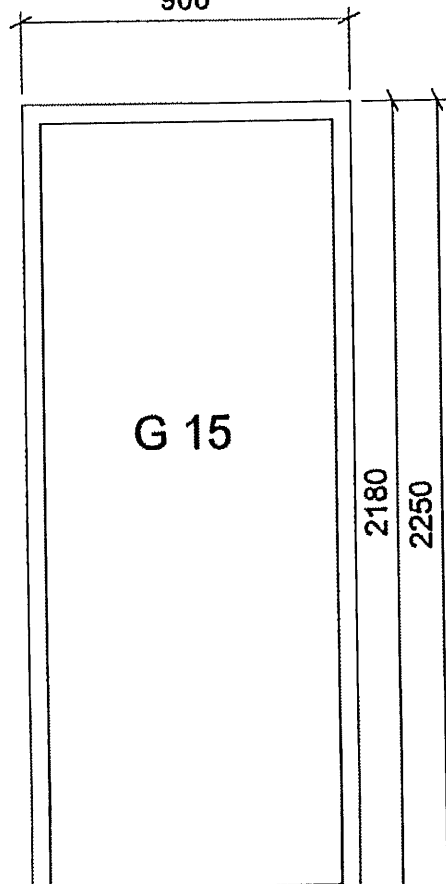
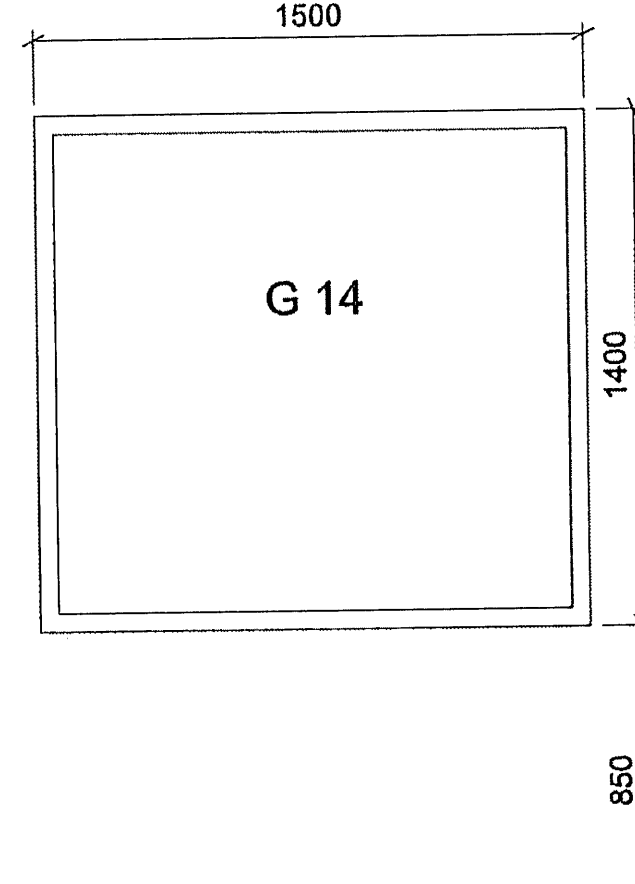
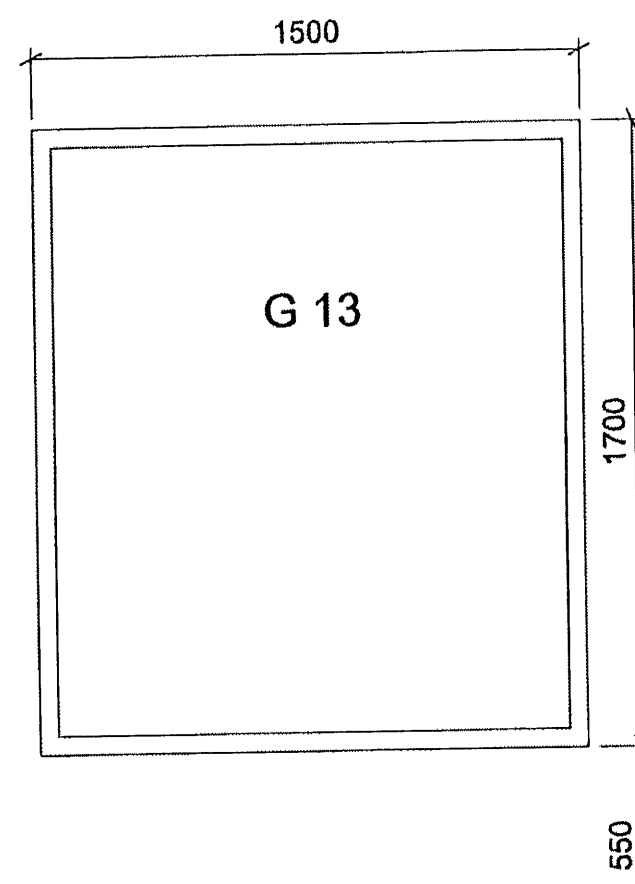

FGK

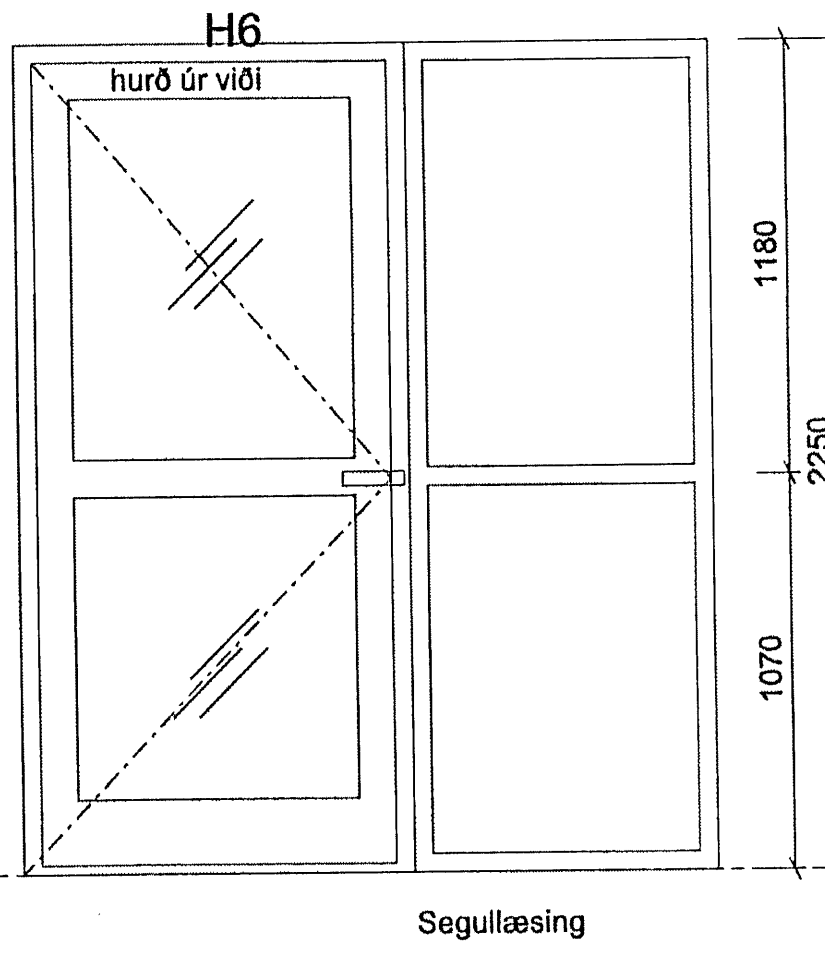
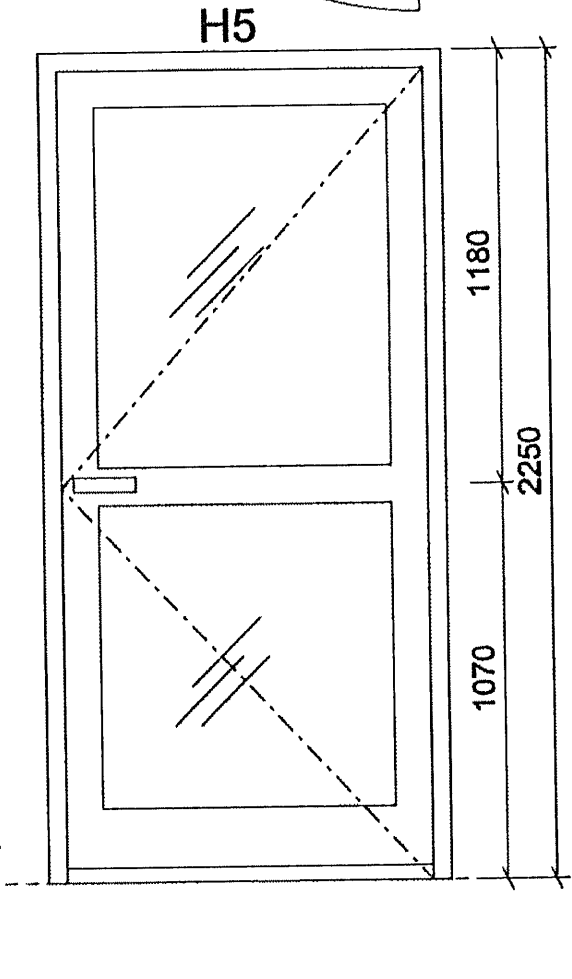
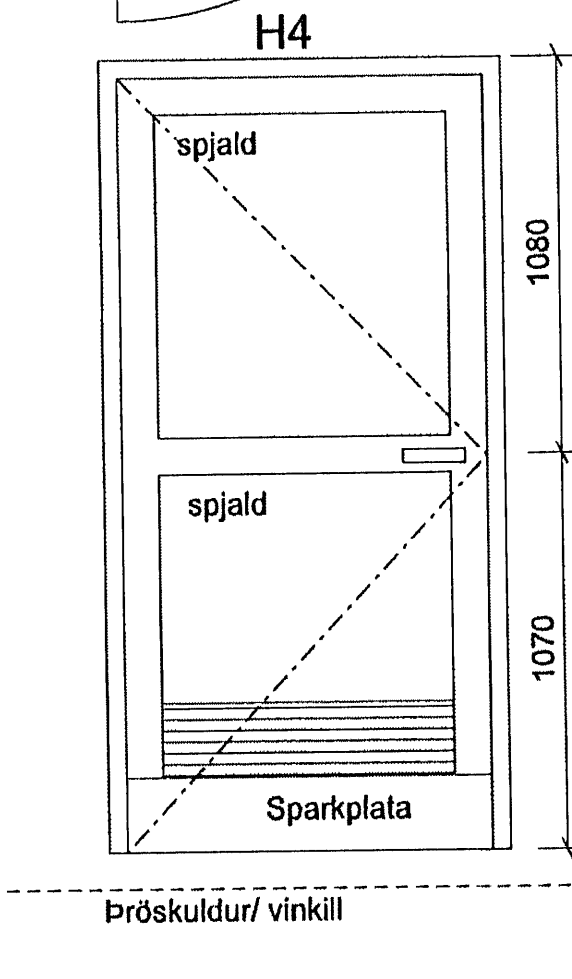
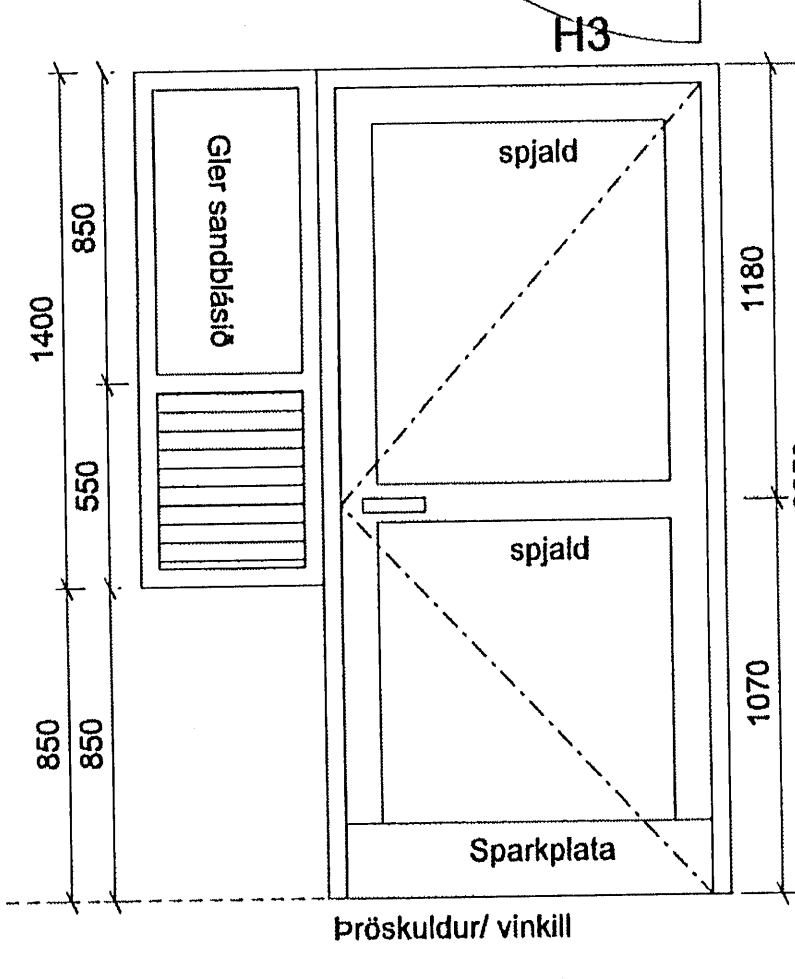
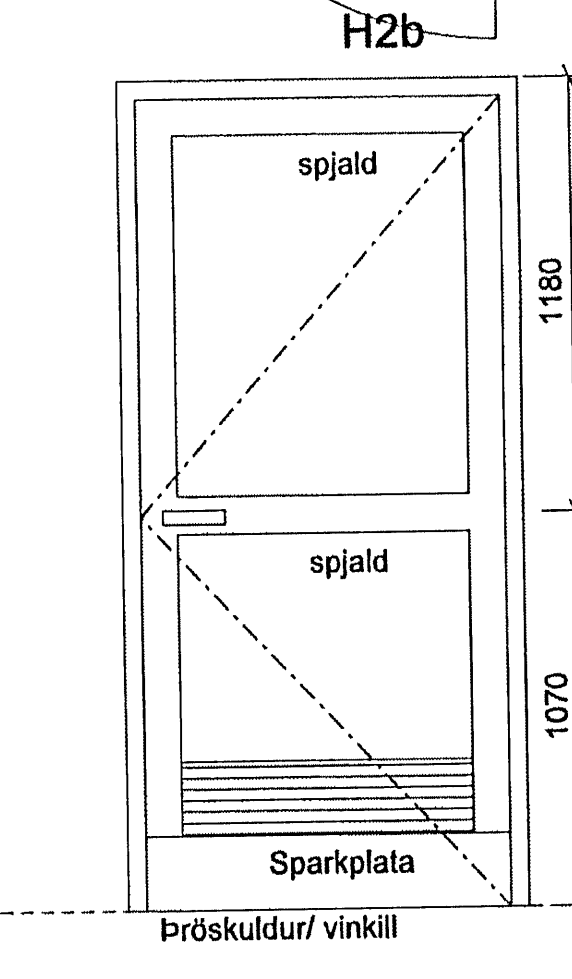
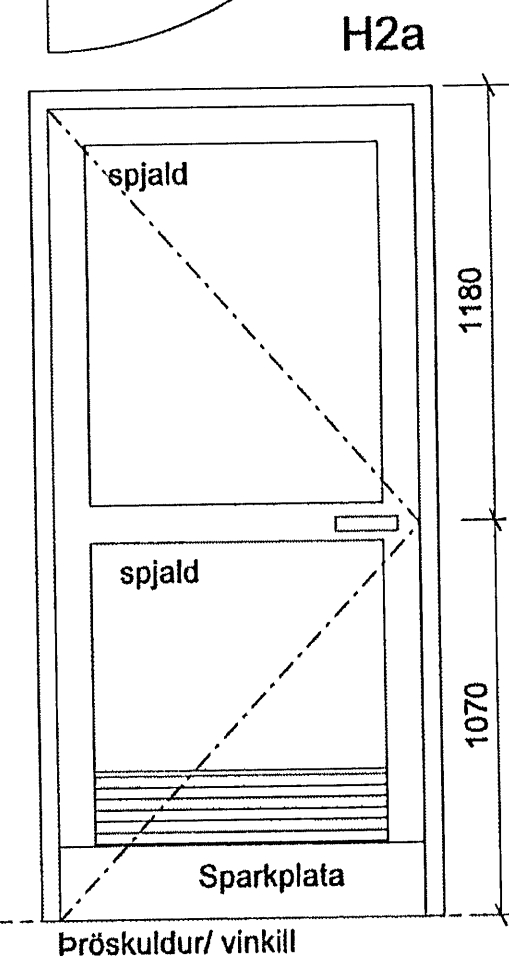
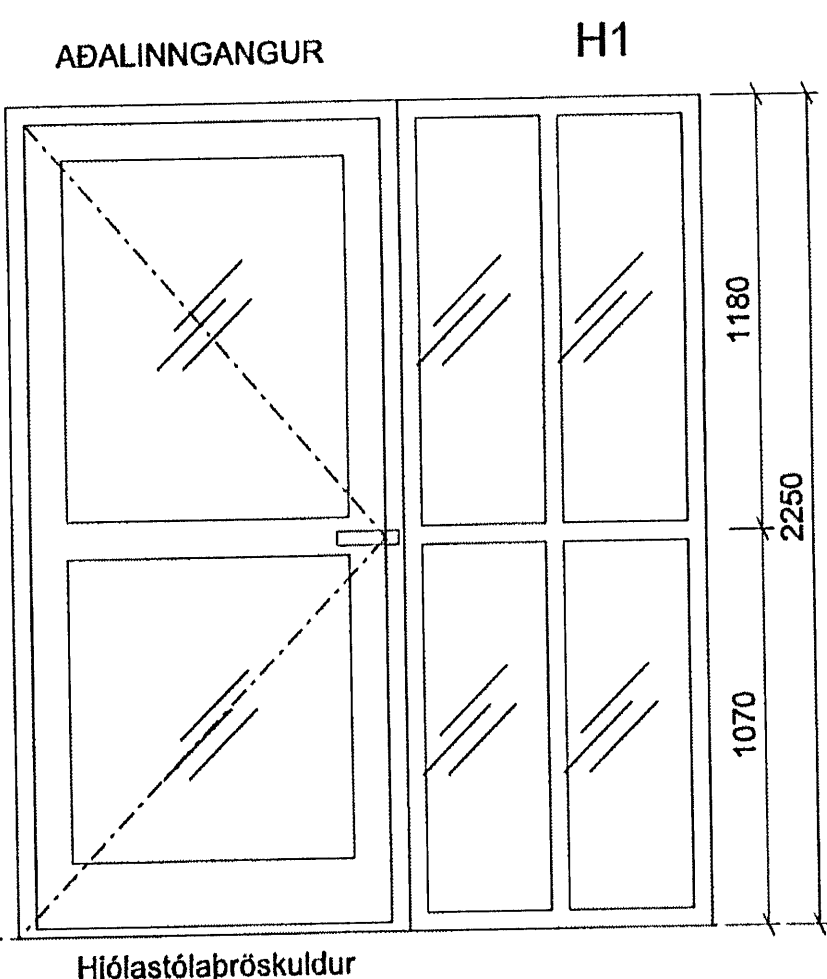
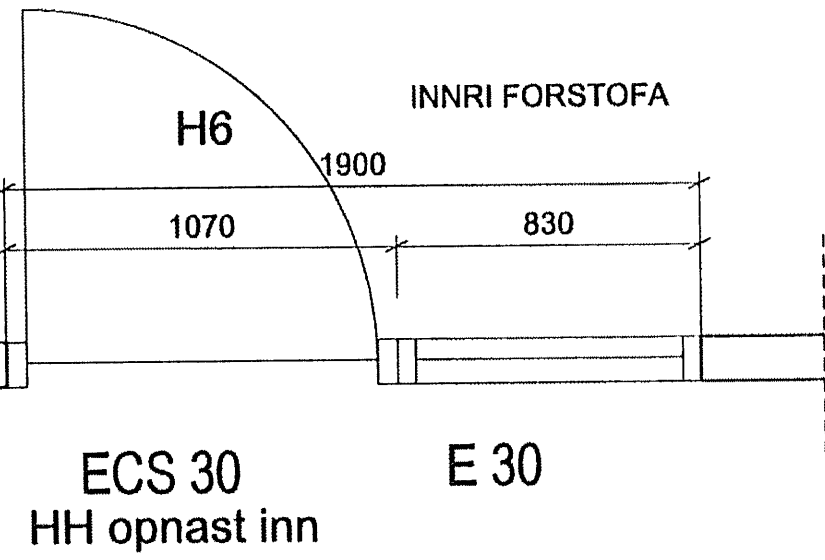
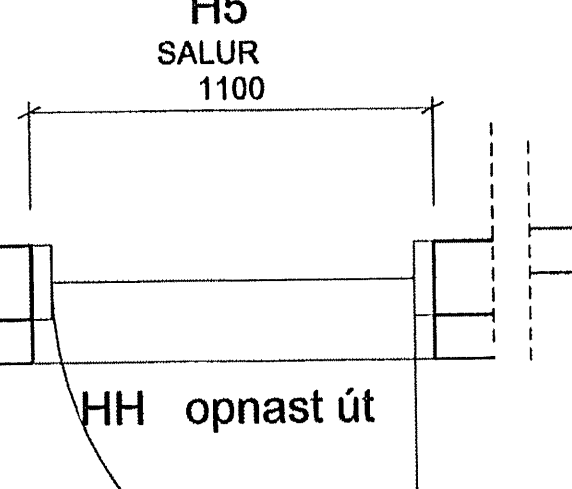
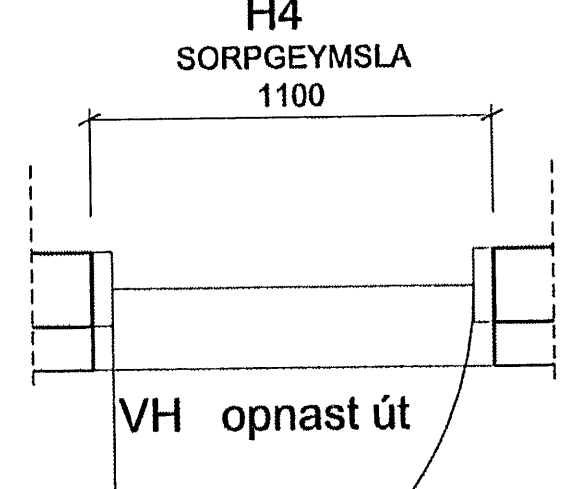
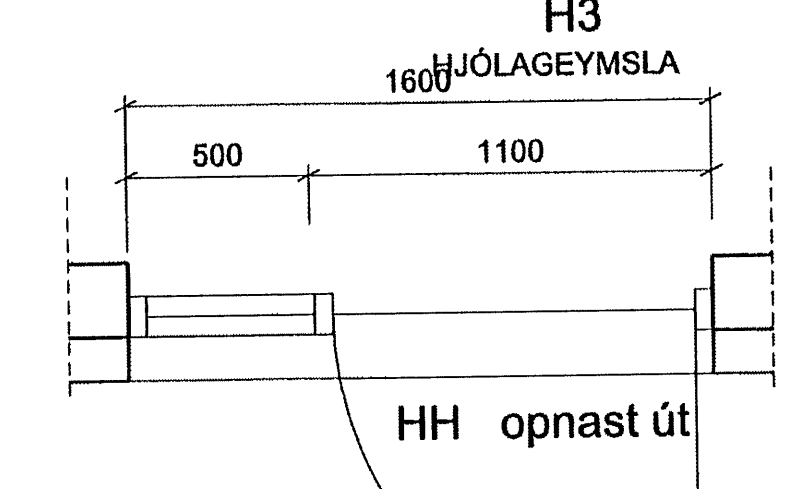
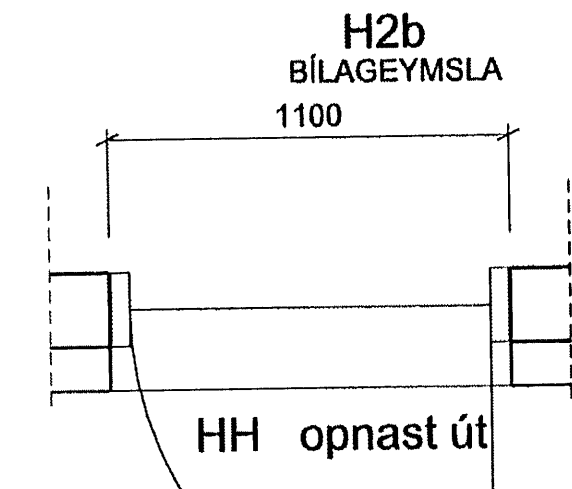
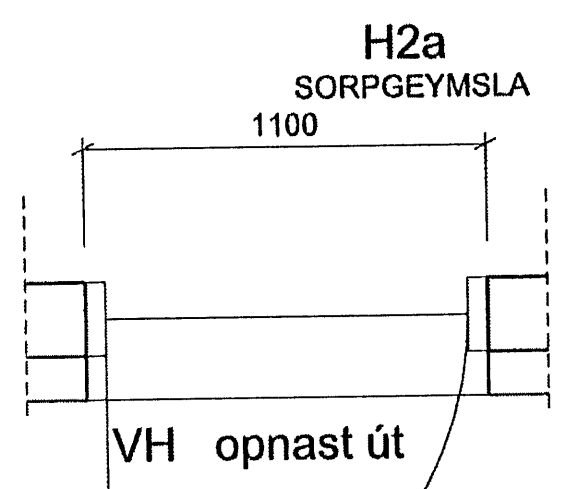
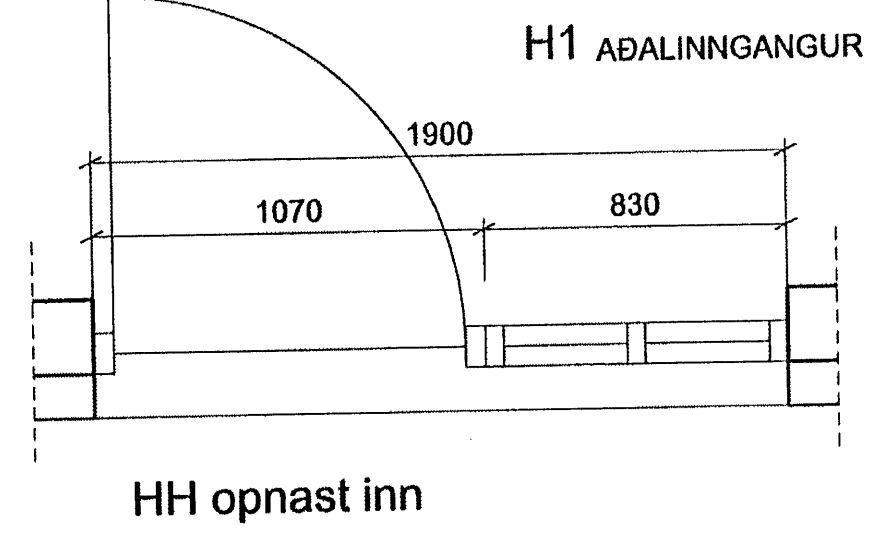

FGK

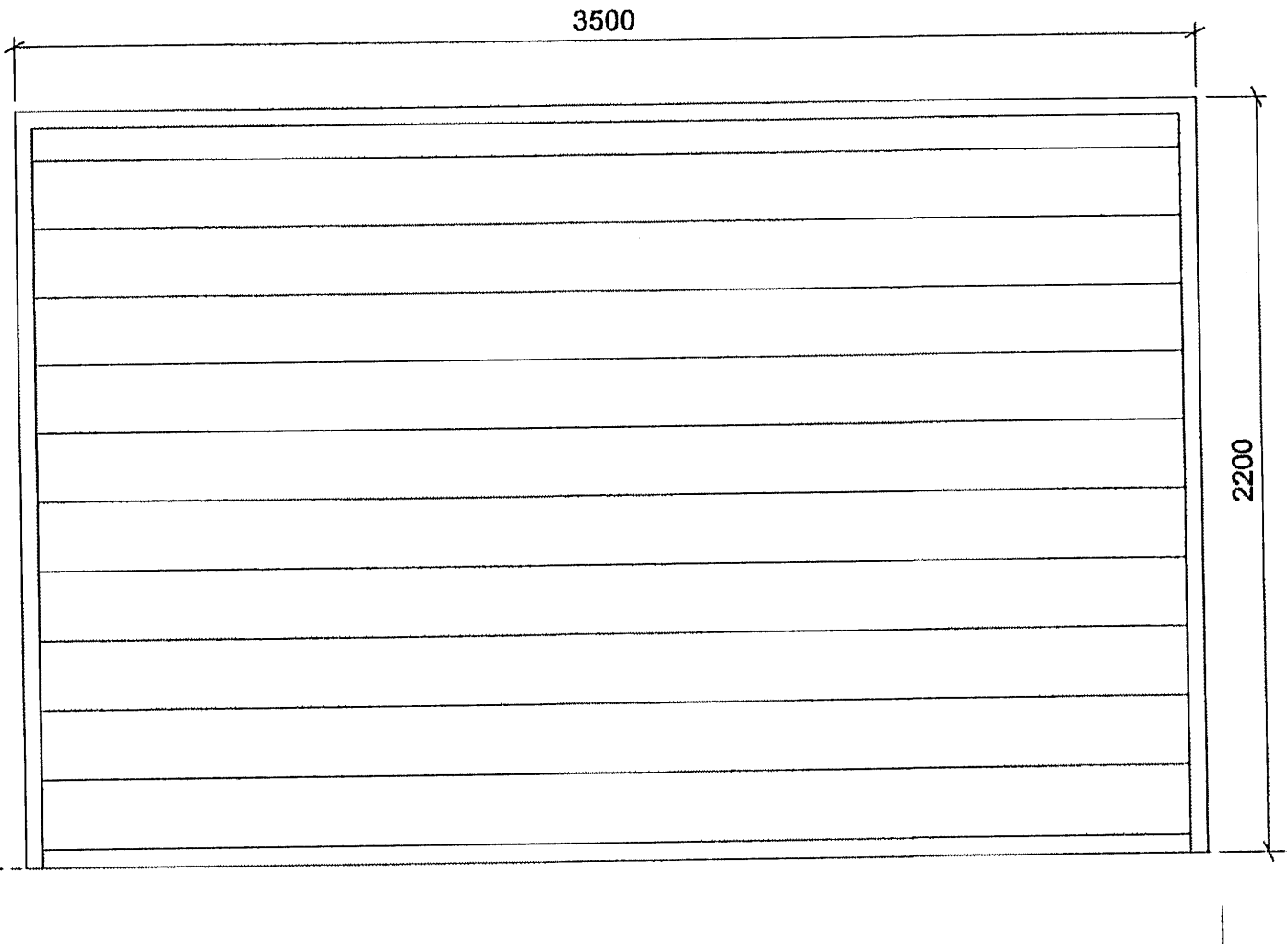
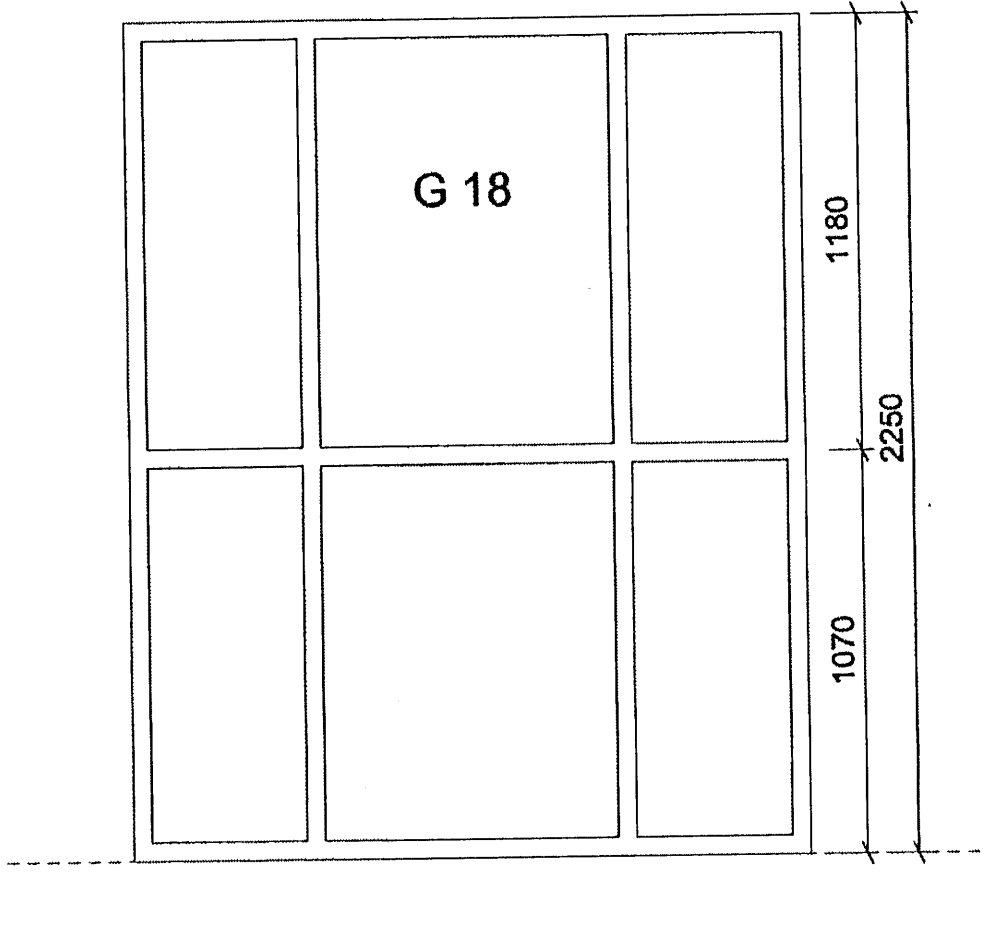
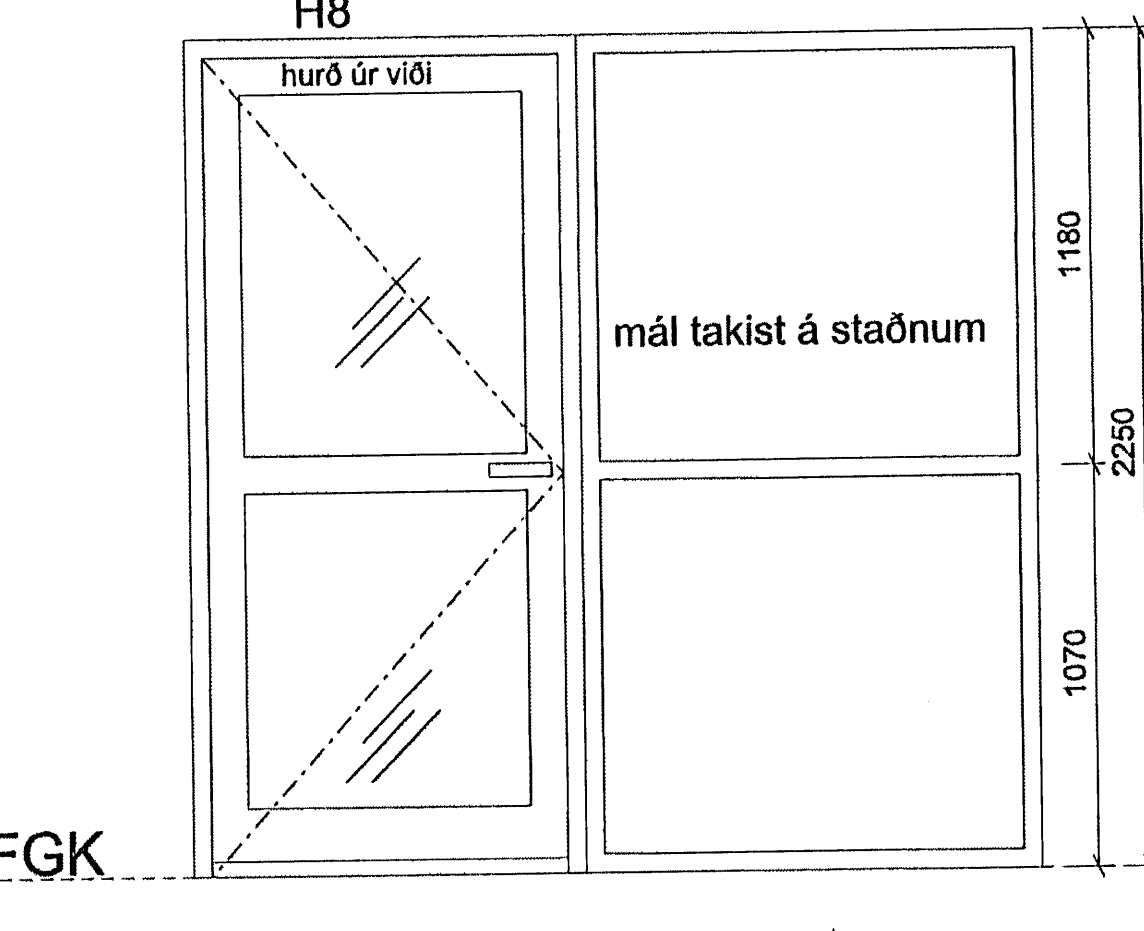
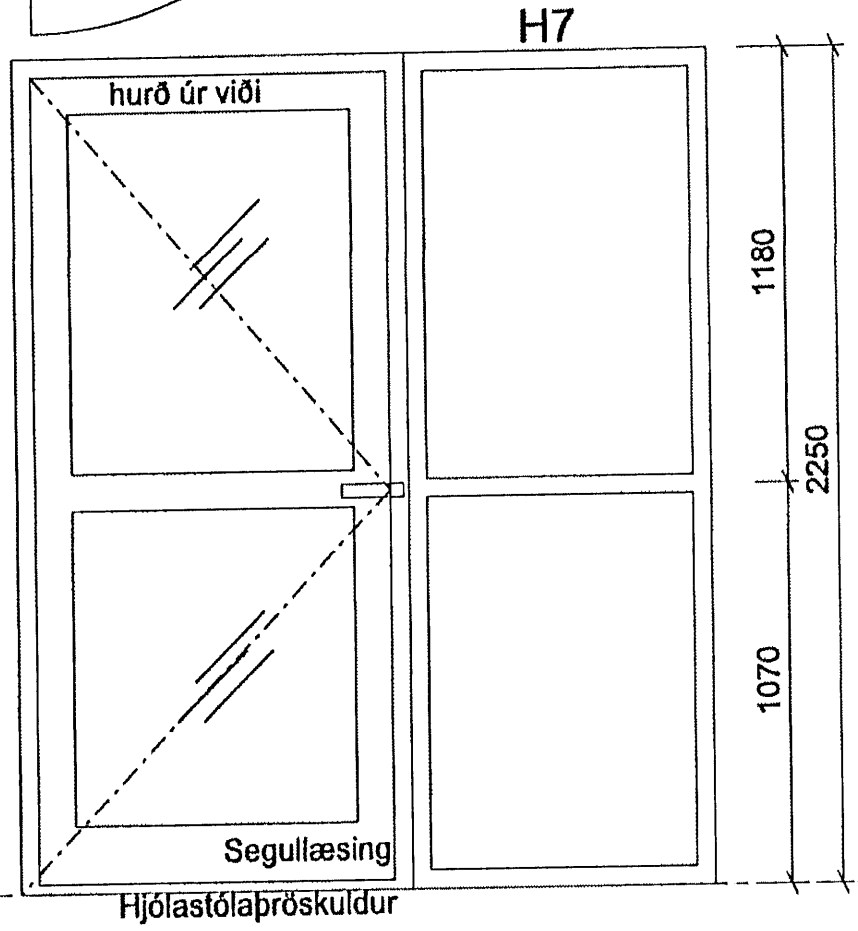
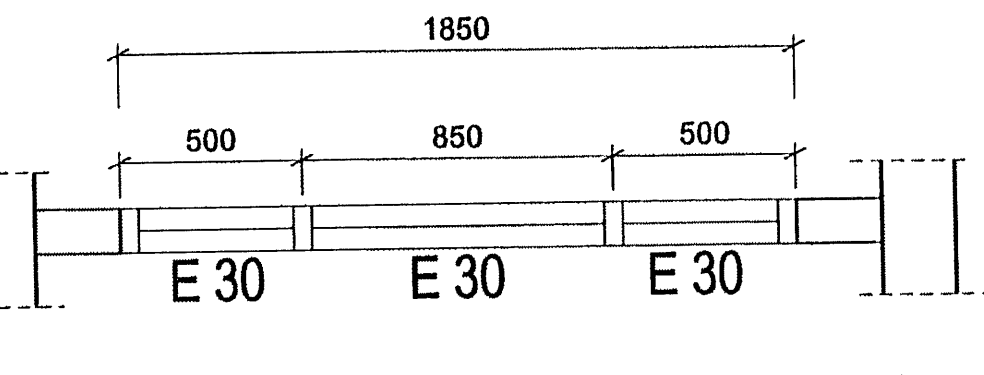
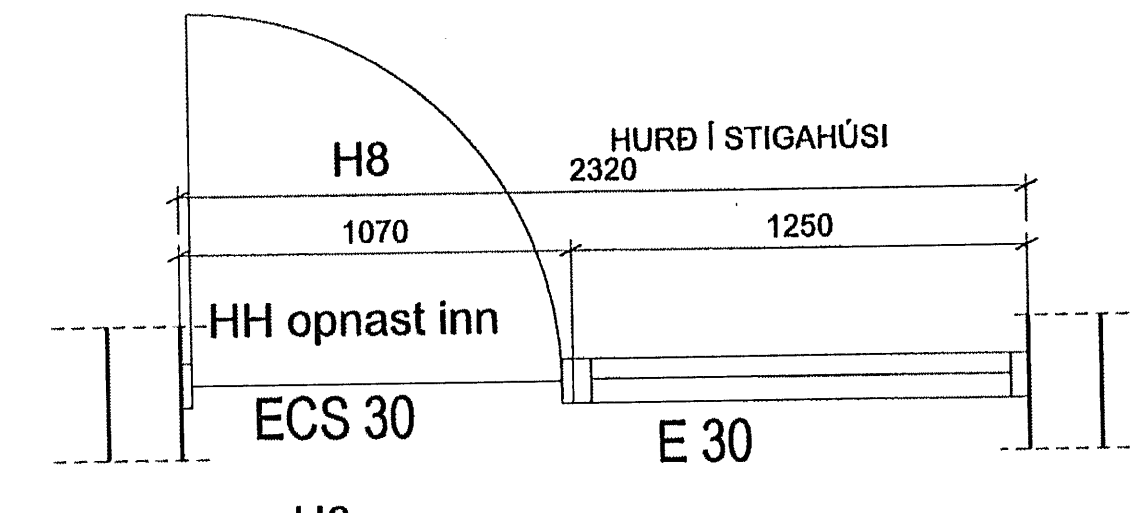
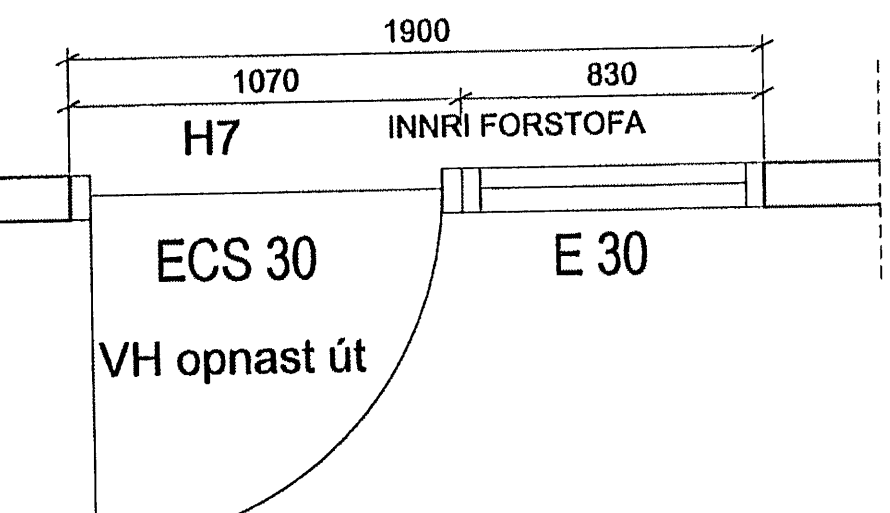

FGK

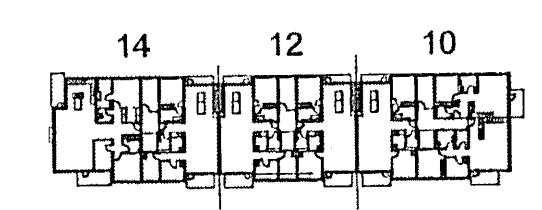

UTGAFA | TEIKNING | SAMBÝKURT | DAGS

ASK Arkitektar
Galgáttu 9
101 Reykjavík
Sími 515 0300
Fax 515 0319
www.ask.is

Aftun aðalhönnuðar
Páll Gunnlaugsson
Páll Gunnlaugsson arkitekt PÁL nr. 210552-2199

SKIPALÓN 10-14
VERKTEIKNINGAR

HEITI TEIKNINGAR
Gluggar og hurðir

MRV. I AT
TEIKNING
ASK
DAGS
15.11.2007

VERK NÚM.
0687

NÚMBER TEIKNINGAR
31-02

UTGAFA
A