

V.1

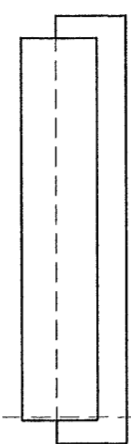

V.2

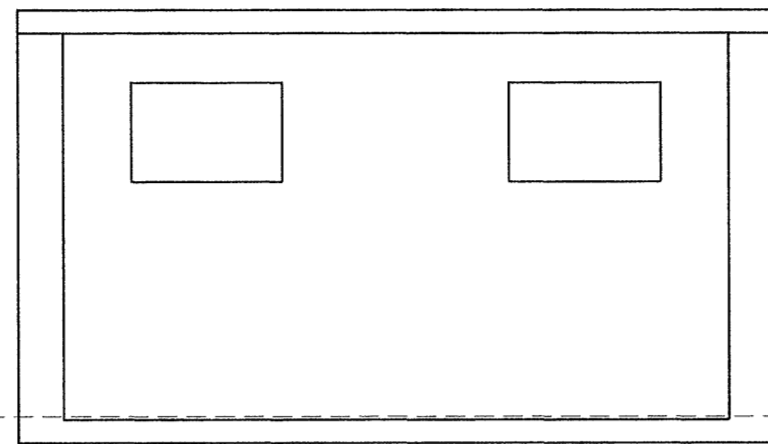

V.3

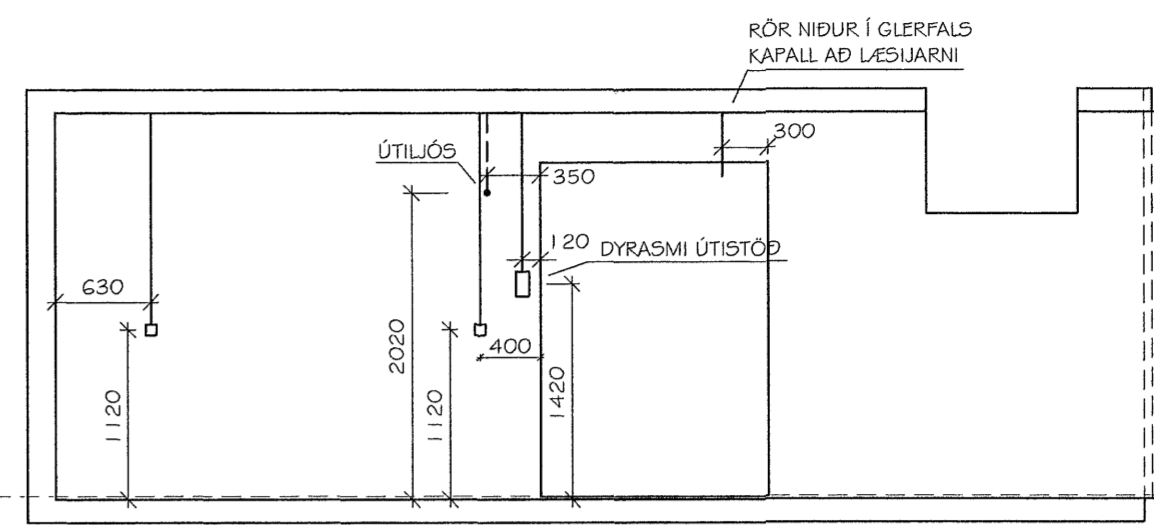

V.4

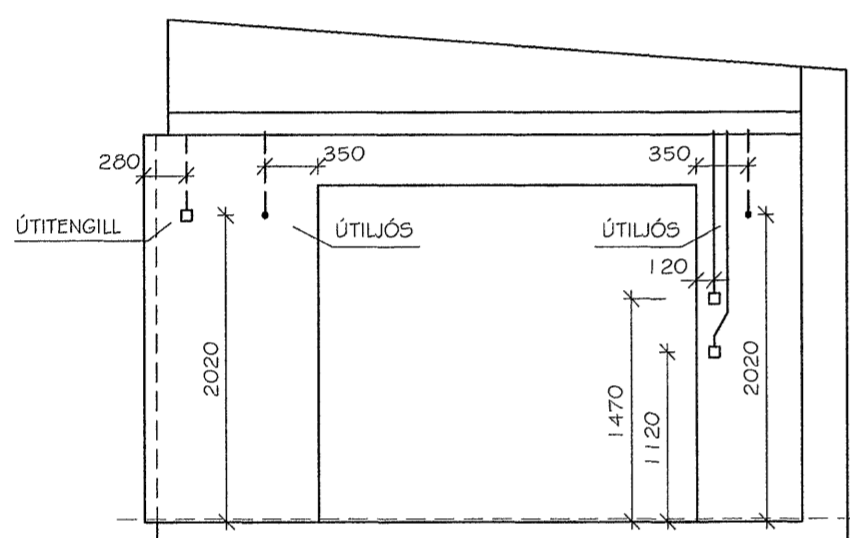
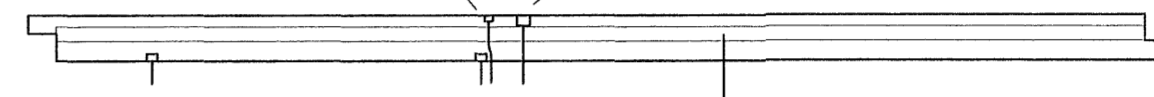
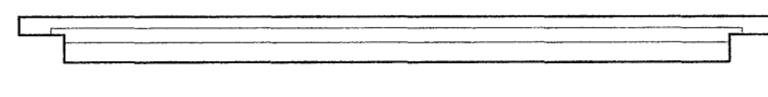
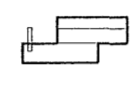
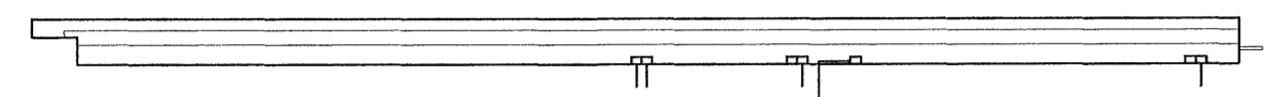

V.5

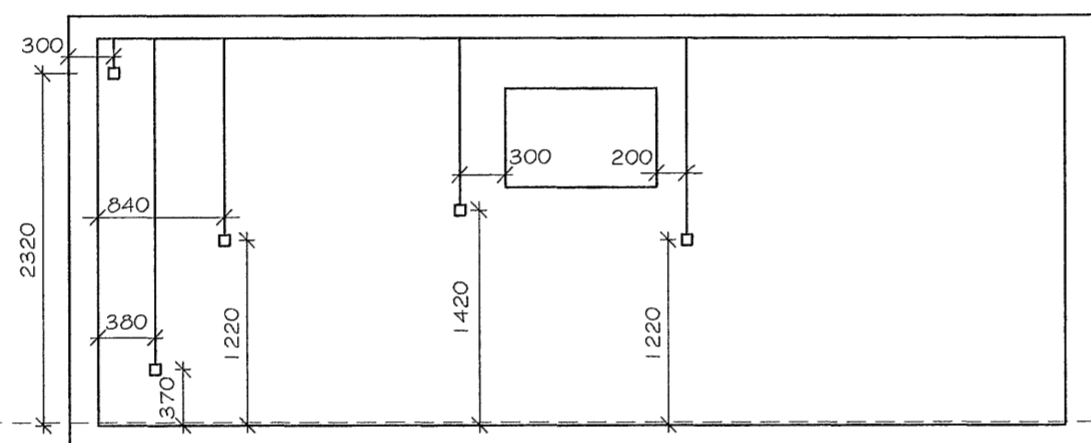

V.6

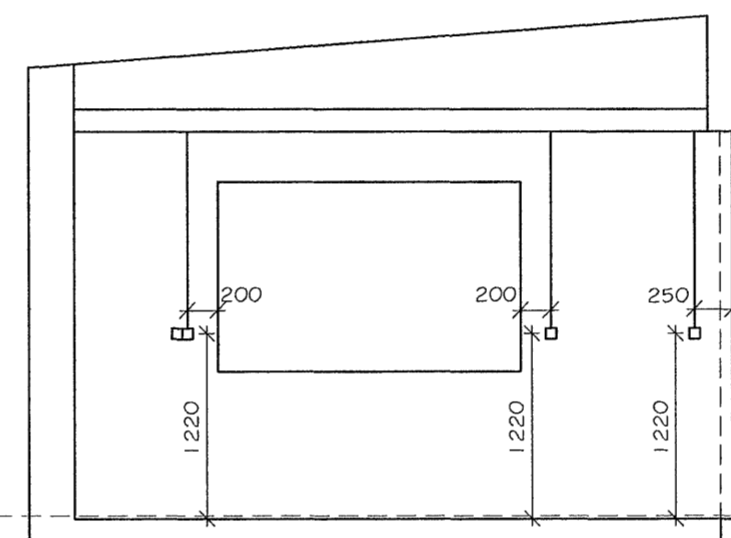

V.7

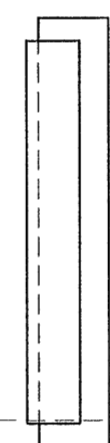

V.8

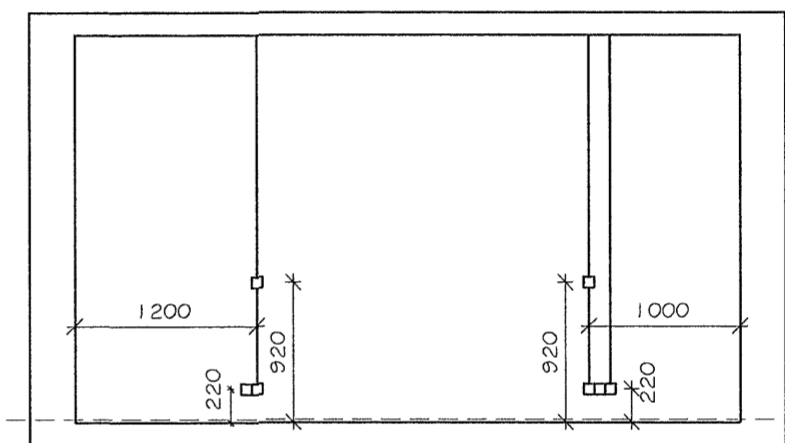

V.9

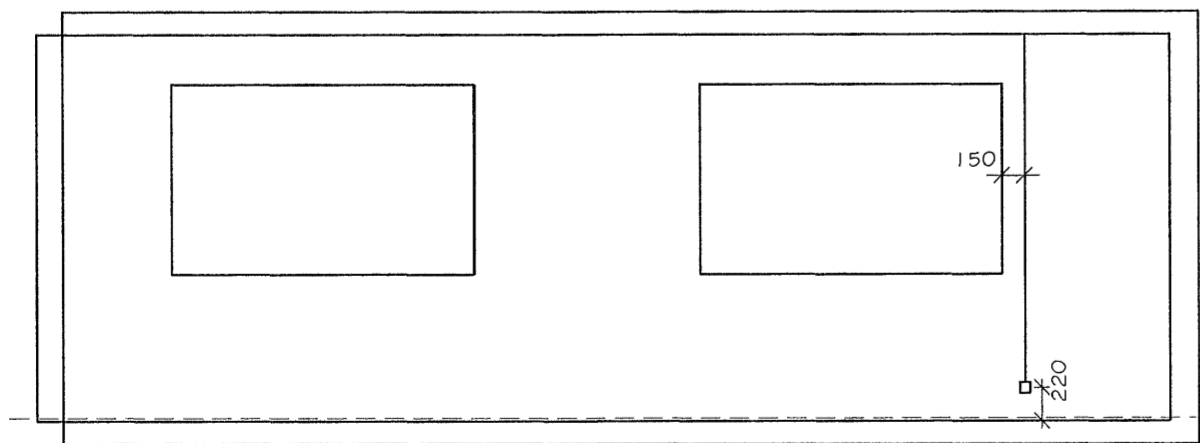
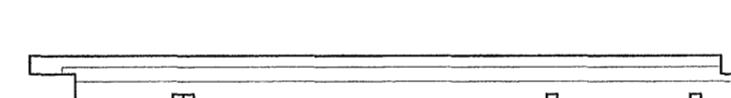
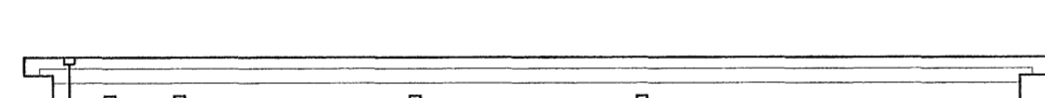
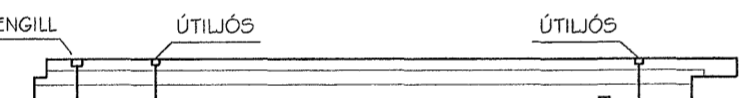

V.10

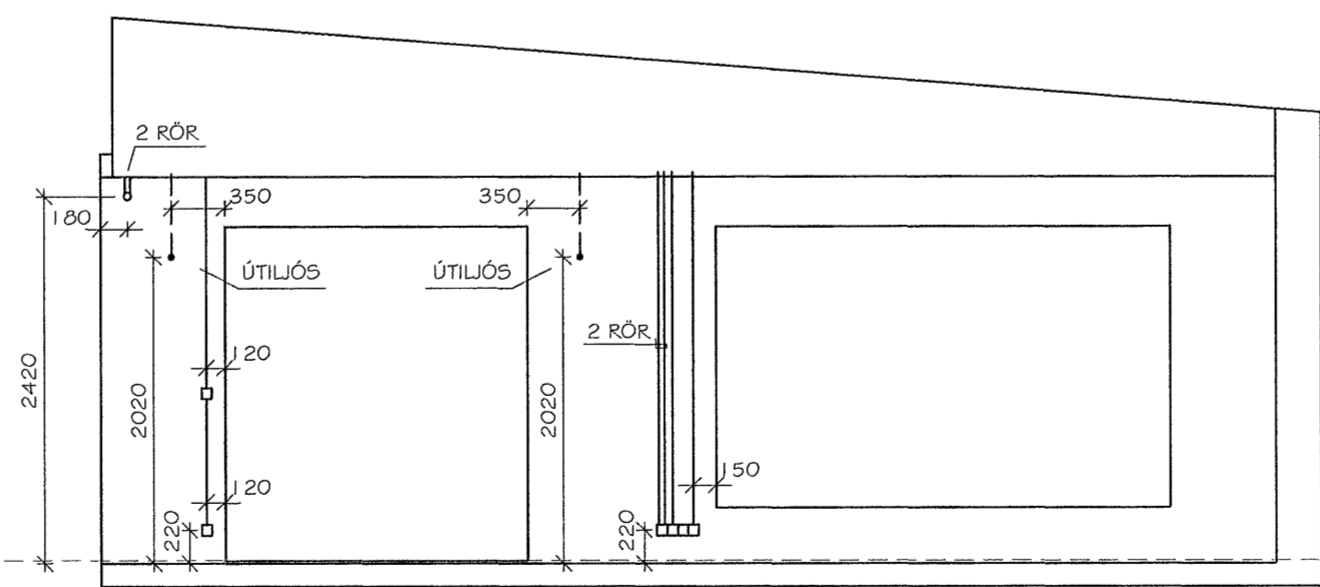

V.11

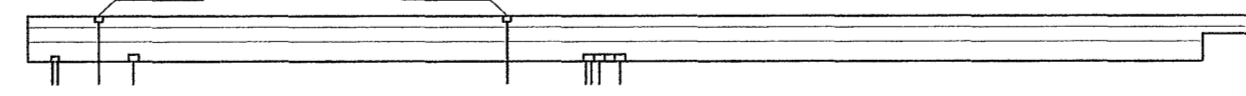
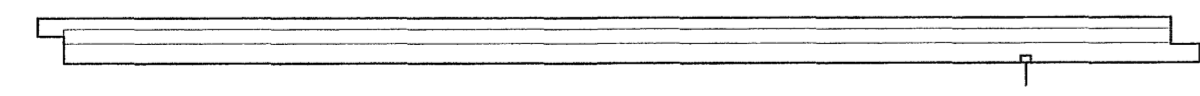

BREYTING 1: _____
 BREYTING 2: _____

RAFLAGNAHÖNNUN
BRAGI ÞÓR SIGURDÓRSSON
 KIRKJUBRAUT 40, 300 AKRANESI
 Símar 431-4200, 893-2081, Netfang: bragi@aknet.is

HEITI VERKS
 BLÓMAVELLIR 2. HAFNAFIRÐI

HEITI TEIKNINGAR
 RAFLAGNIR Í ÚTVEGGJAEININGUM

PLÖTTAD: 29/10/2002	TEIKNAD: OKT. 2002	BLAD: A2
KVARDI: 1:50	TEIKNAD: BPS	VERK NR: 02-046
SKRÁ: BLÓMAVELLIR 2-EIN		
GEYMSLUNR: MYND/2002/02-046 BLÓMAVELLIR 2		
SAMP:		BLAD NR: 5