

EI-CS30
STK. 1, Yfirfara og endurbæta

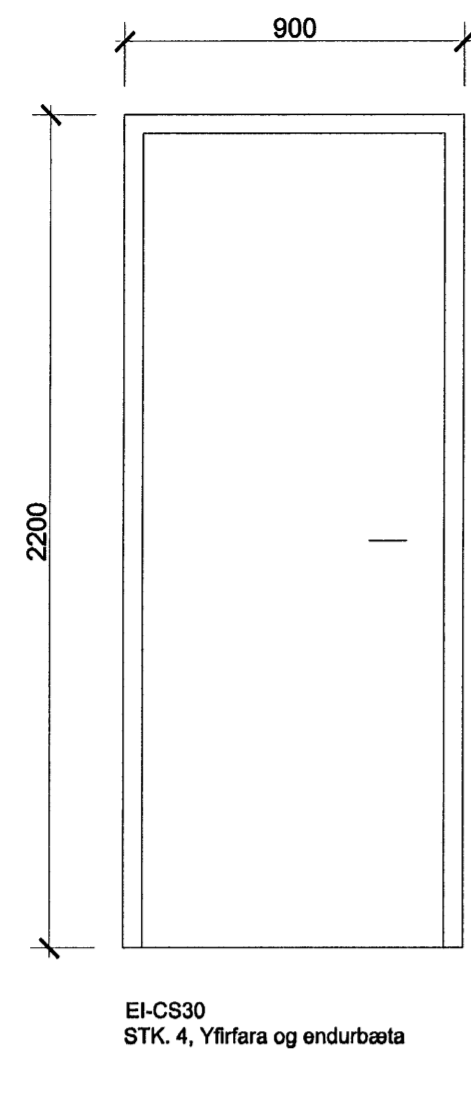

EI-CS30
STK. 4, Yfirfara og endurbæta

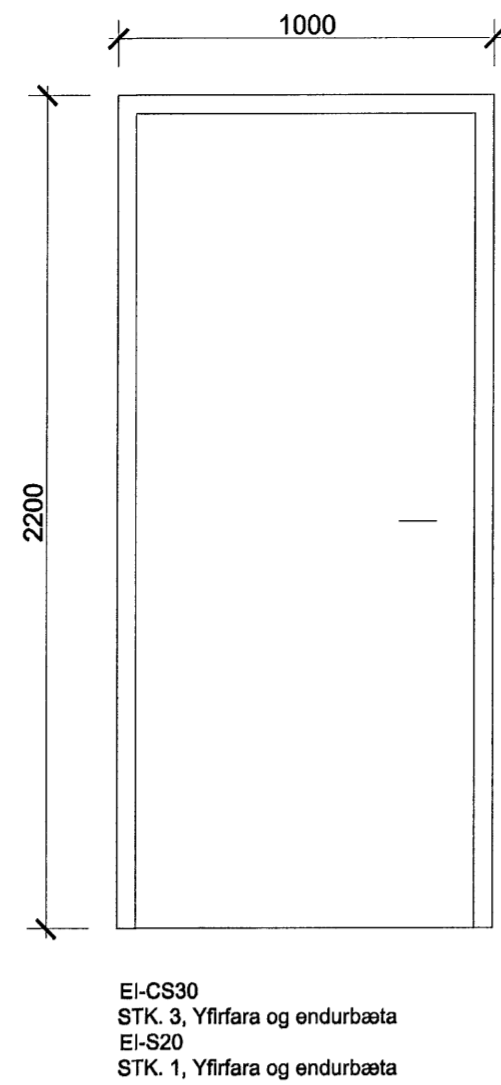

EI-CS30
STK. 3, Yfirfara og endurbæta
EI-S20
STK. 1, Yfirfara og endurbæta

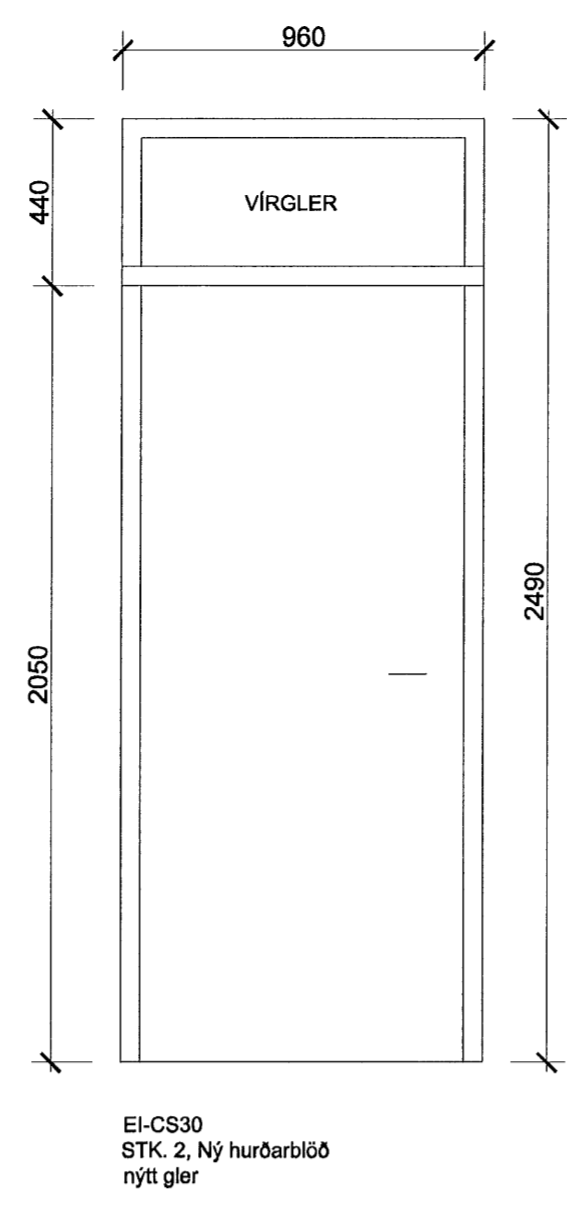

EI-CS30
STK. 2, Ný hurðarblöð nýtt gler

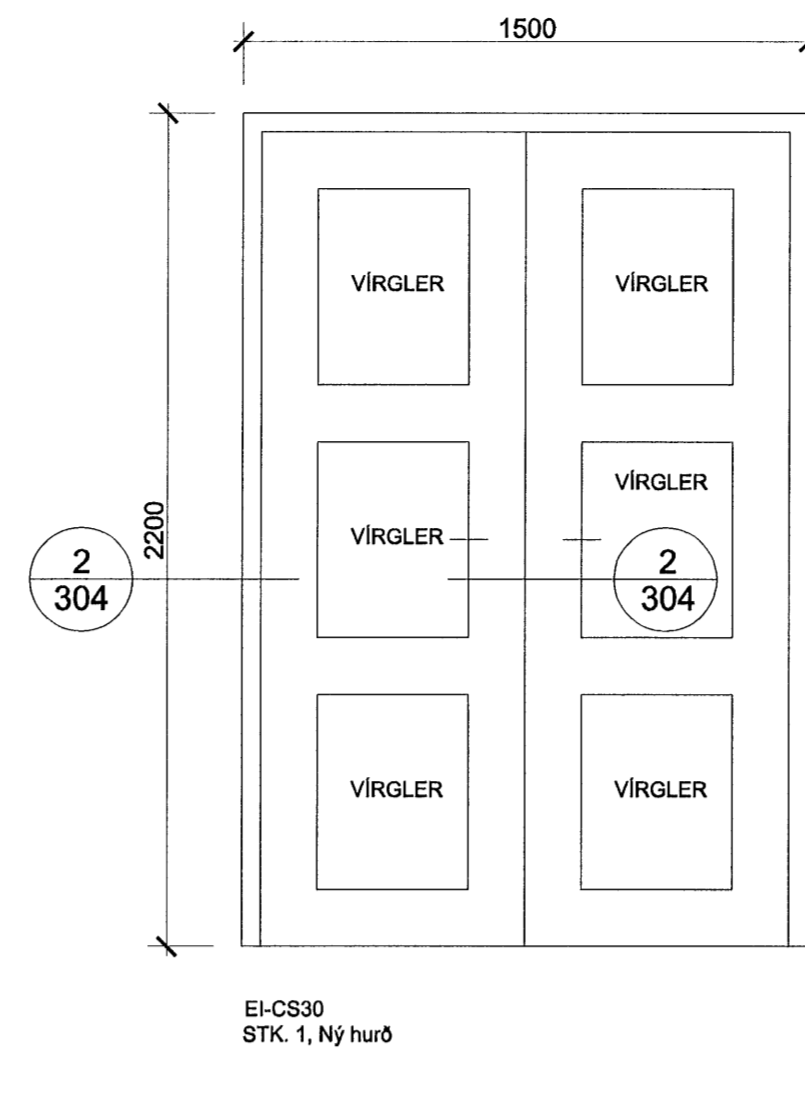

EI-CS30
STK. 1, Ný hurð

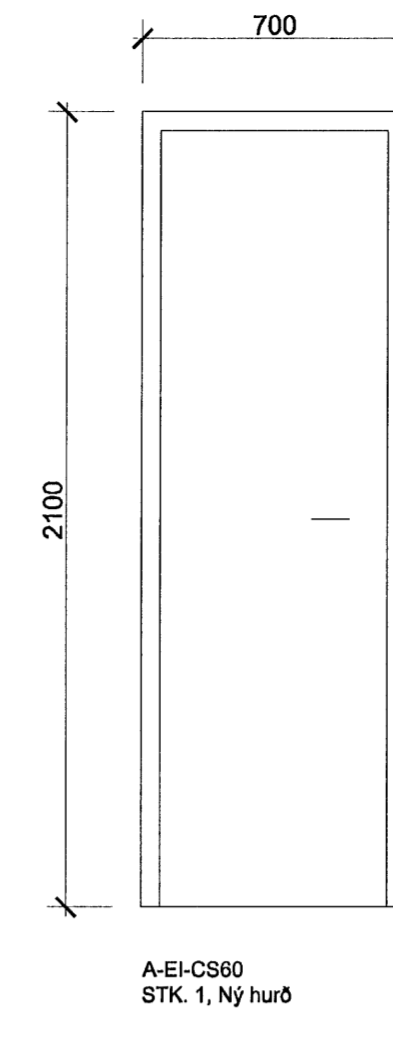

A-EI-CS60
STK. 1, Ný hurð

HURDIR 3. HÆÐ
13 STK. ALLS

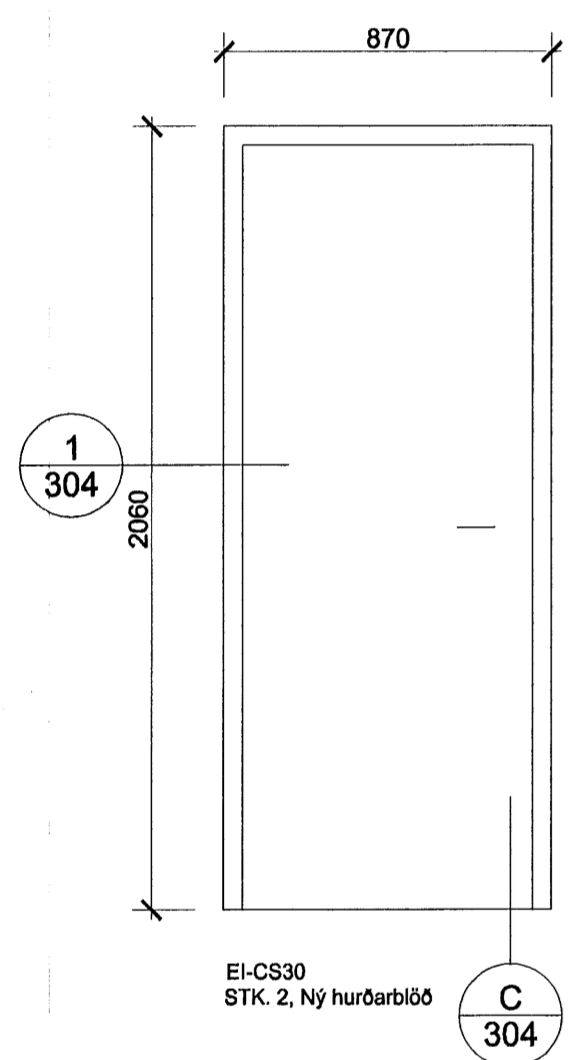

EI-CS30
STK. 2, Ný hurðarblöð

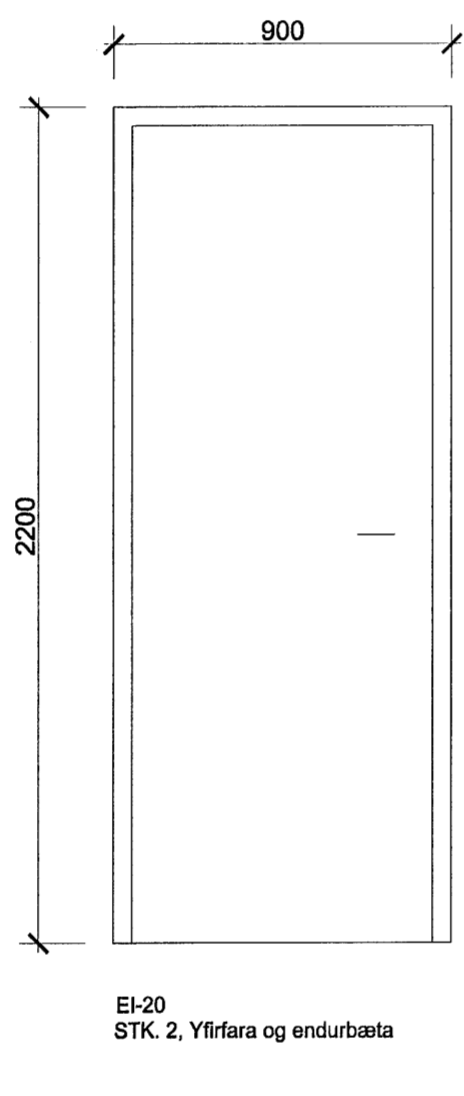

EI-20
STK. 2, Yfirfara og endurbæta

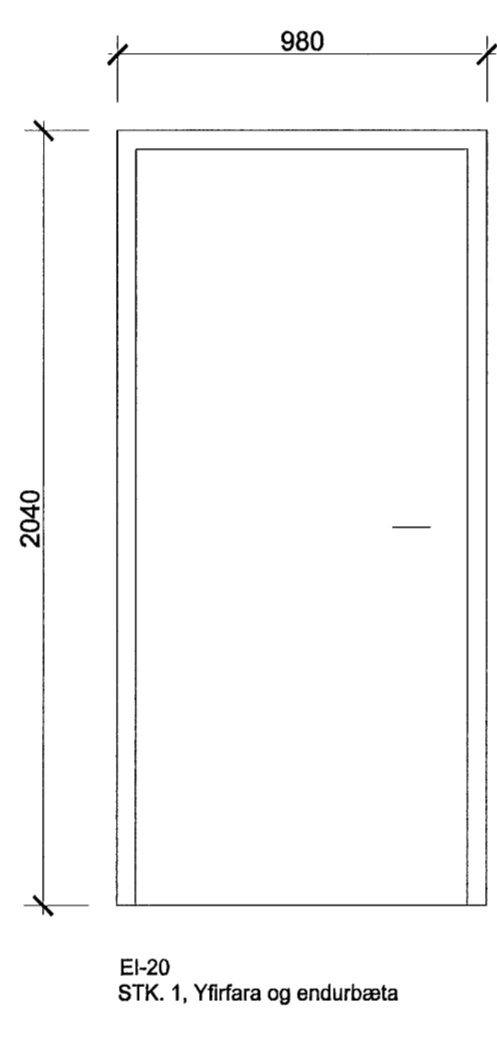

EI-20
STK. 1, Yfirfara og endurbæta

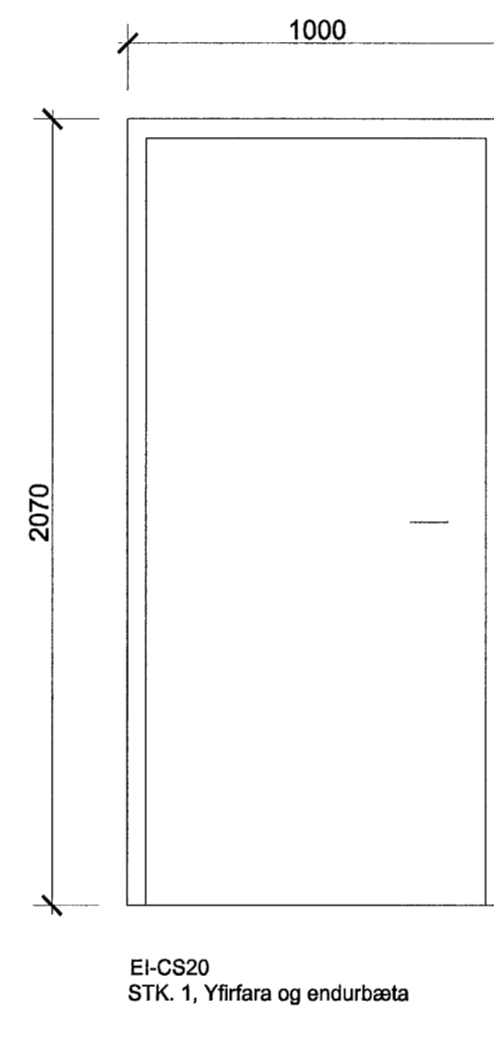

EI-CS20
STK. 1, Yfirfara og endurbæta

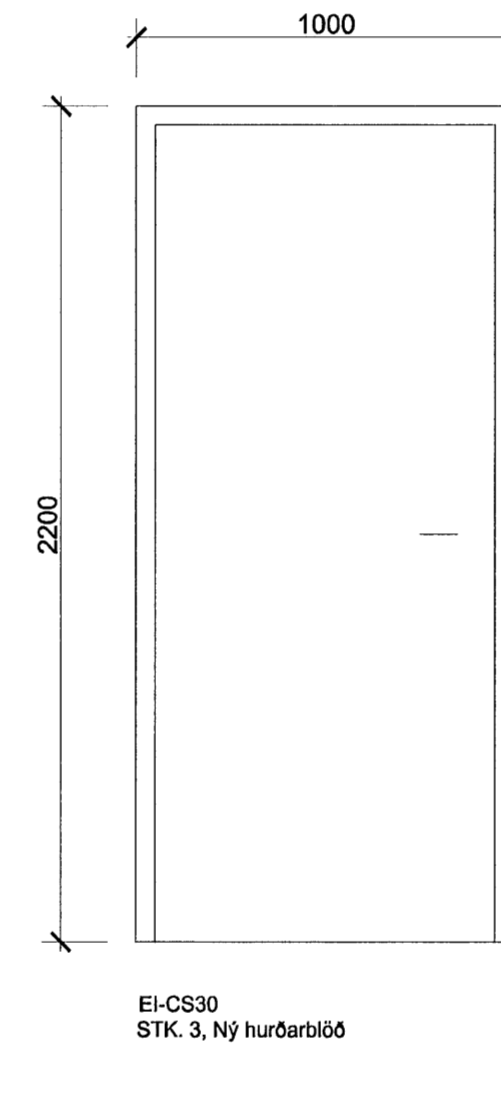

EI-CS30
STK. 3, Ný hurðarblöð

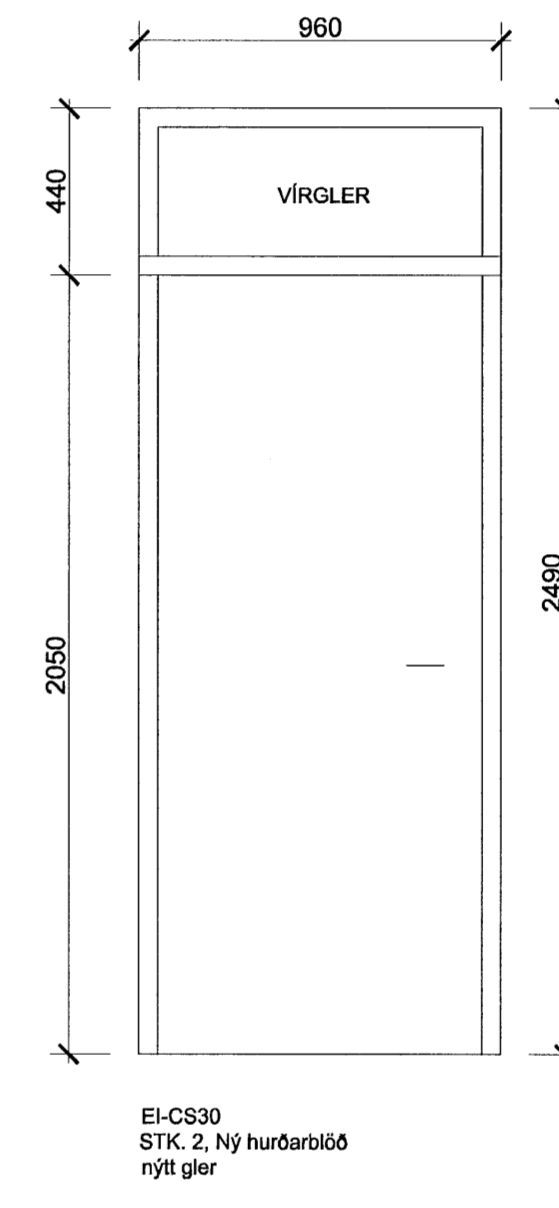

EI-CS30
STK. 2, Ný hurðarblöð nýtt gler

HURDIR 2. HÆÐ
11 STK. ALLS

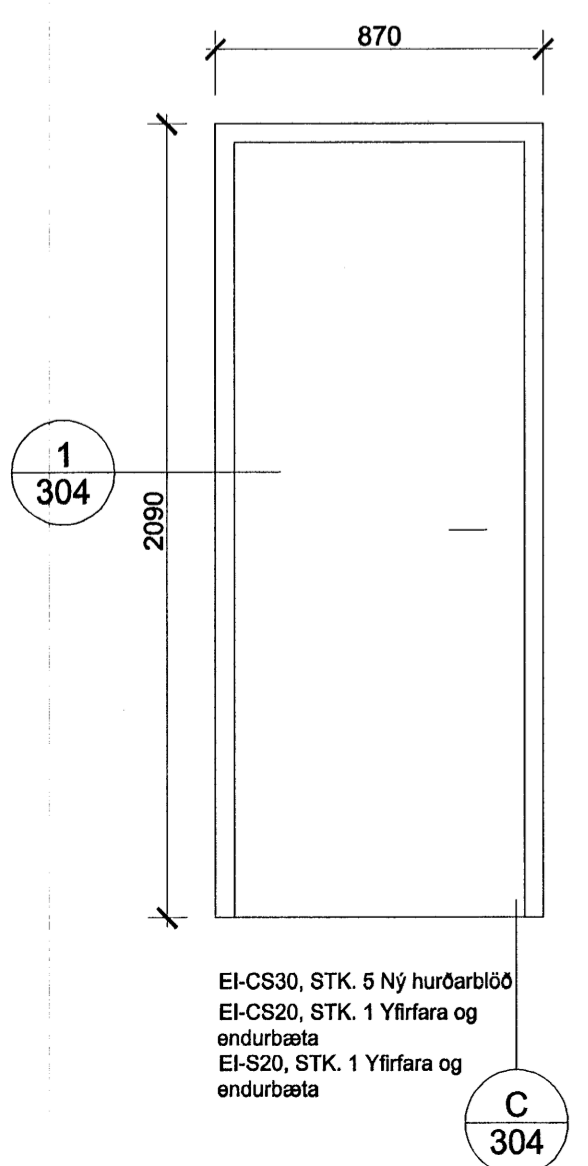

EI-CS30, STK. 5 Ný hurðarblöð
EI-CS20, STK. 1 Yfirfara og endurbæta
EI-S20, STK. 1 Yfirfara og endurbæta

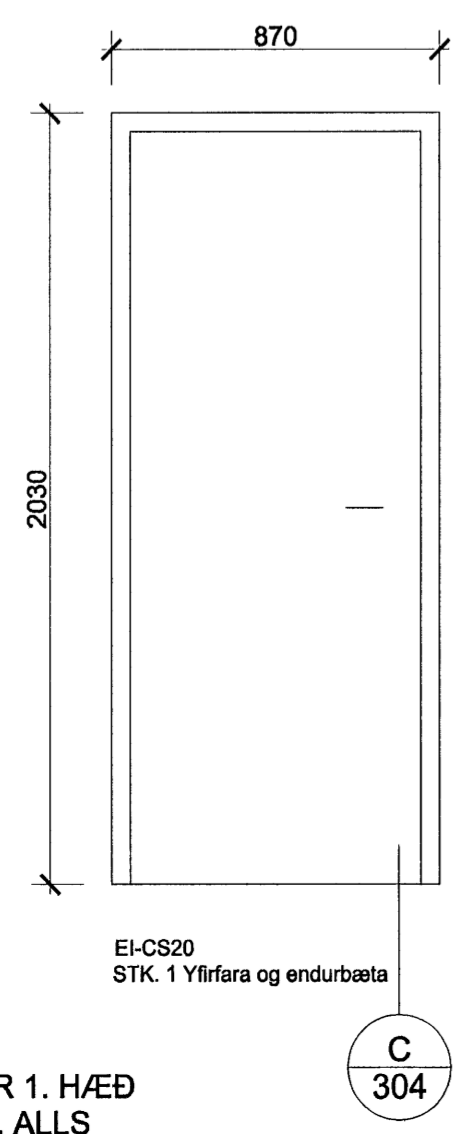

EI-CS20
STK. 1 Yfirfara og endurbæta

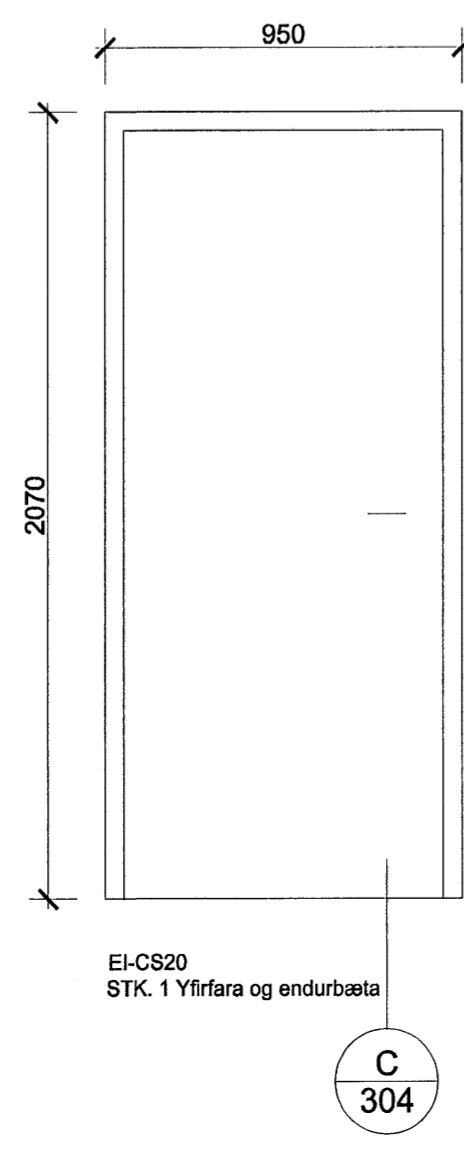

EI-CS20
STK. 1 Yfirfara og endurbæta

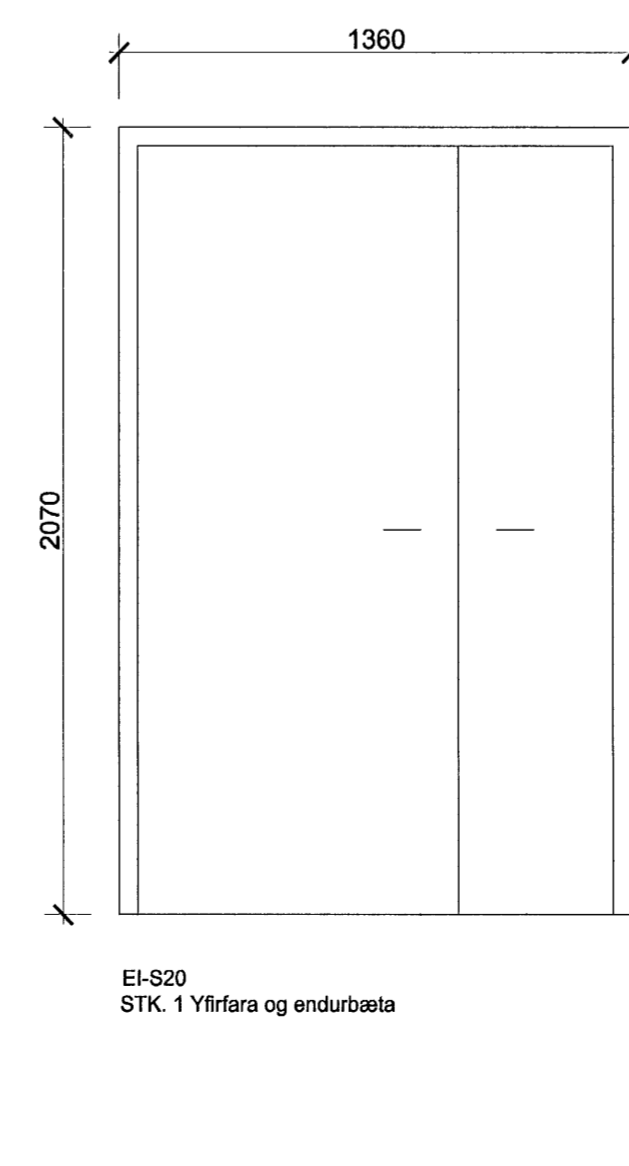

EI-S20
STK. 1 Yfirfara og endurbæta

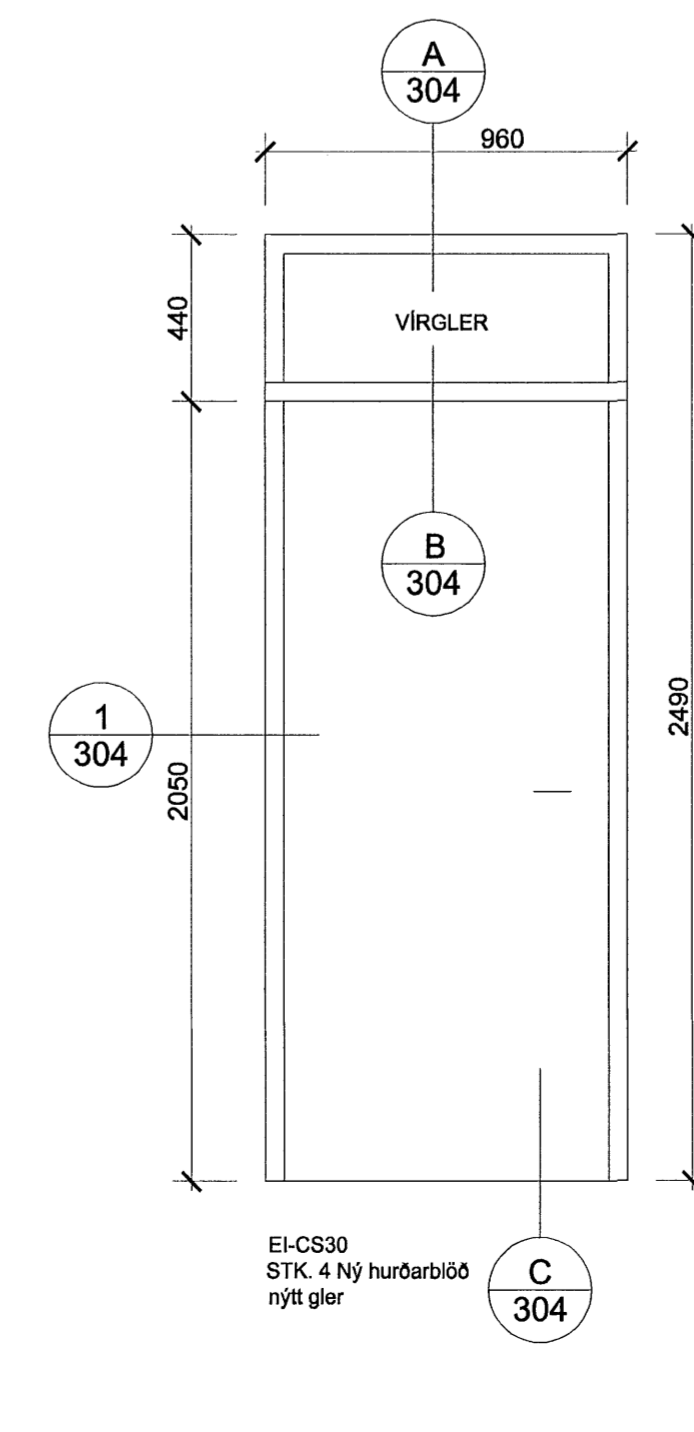

EI-CS30
STK. 4 Ný hurðarblöð nýtt gler

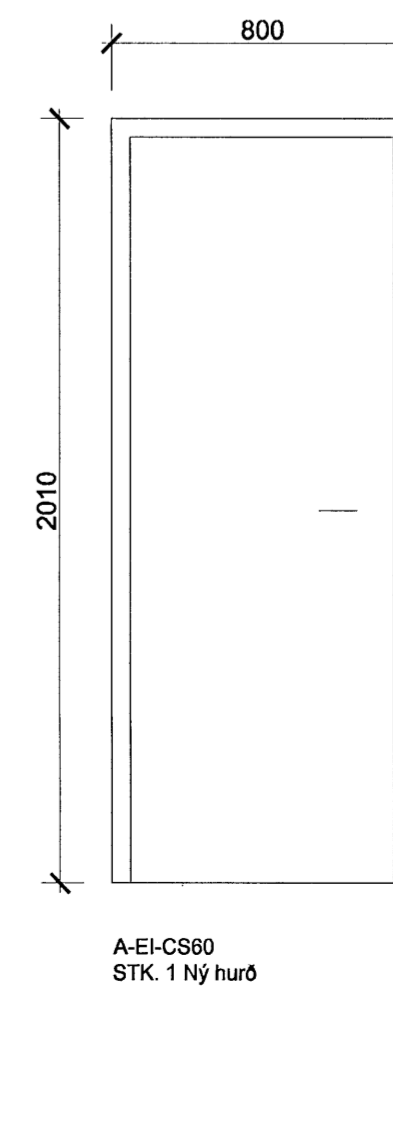

A-EI-CS60
STK. 1 Ný hurð

HURDIR 1. HÆÐ
15 STK. ALLS

VINDUTEKNIÐ

8. júní 2009

ÖLL MÁL ATHUGIST Á STAÐNUM

STADUR SKÓLABRAUT		
VERK: LÆKJARSKÓLI INNIHURÐIR 1, 2 OG 3. HÆÐ		
TEKNIÐ HURÐIR		
ÁMELKVARÐI 1 : 20	VERNR: 236 A	TEKNIÐAFNR: 302
TEKNIÐ: 19.04.00	BBÓ	
ARKITEKTASTOFAN ORMAR ÞÓR GUÐMUNDSSON OG ÖRNÓLFUR HALL KT 020225-4659		
BORGARTÚN 17 105 REYKJAVÍK SÍMI: 562-6833 FARS.: 853-3492 NETF.: ARKITEKTASTOFAN@ARKITEKTASTOFAN.IS FAX: 562-6835		