

GRUNNMYND 1:50

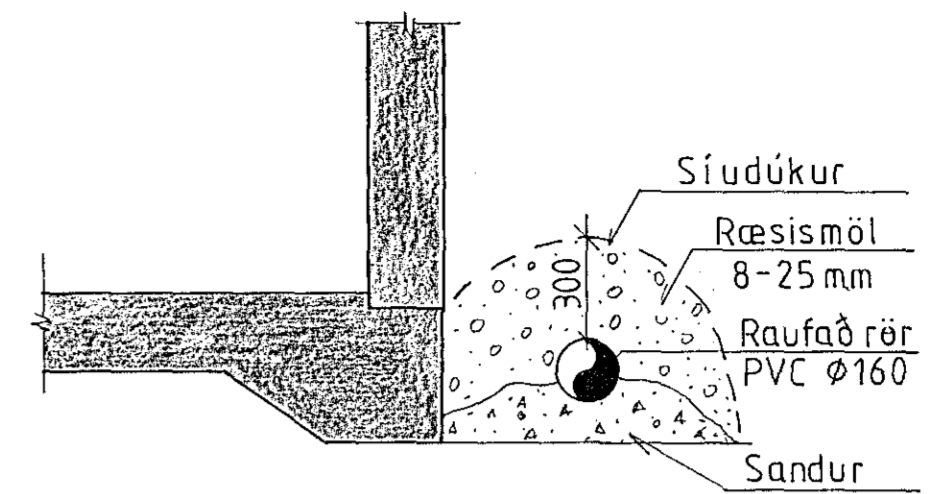

SNID A - A 1:20

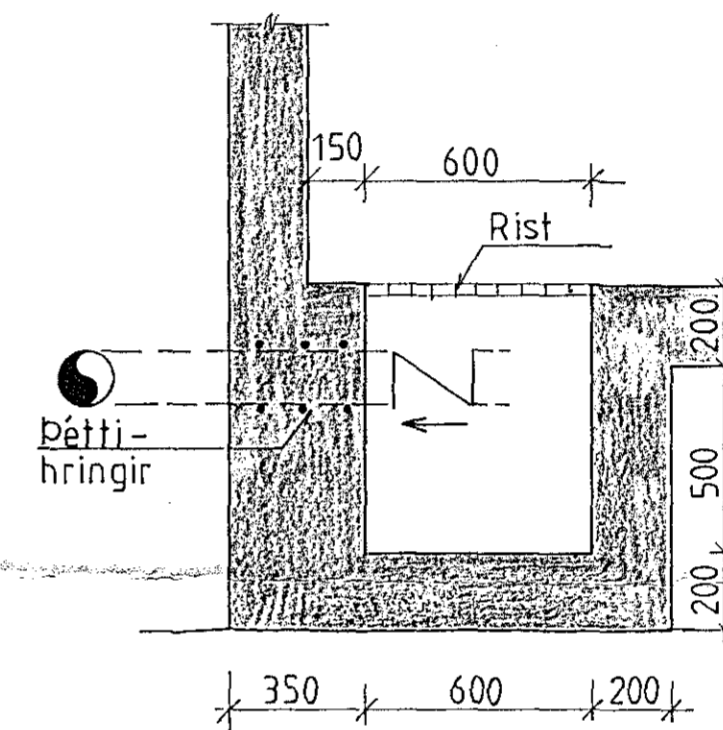

SNID C - C 1:20

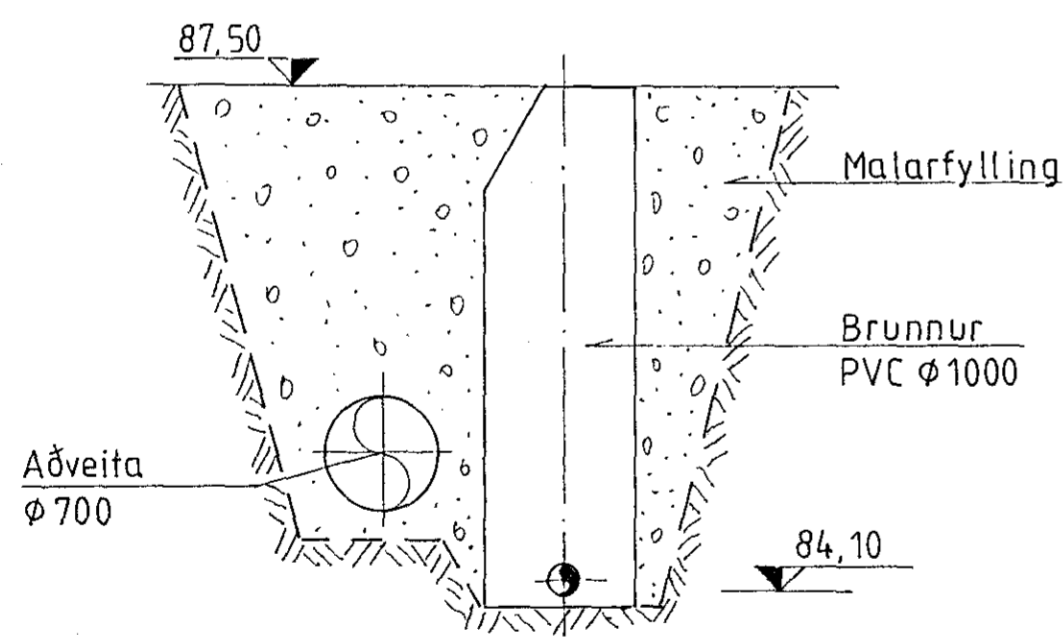

SNID B - B 1:50

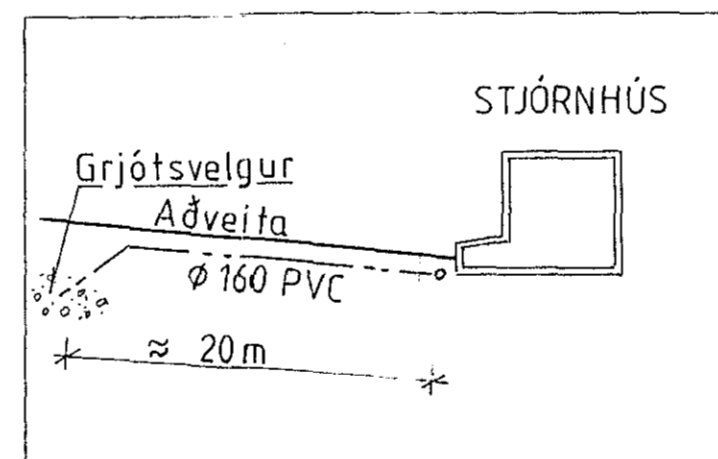

AFSTÖÐUMYND 1:500

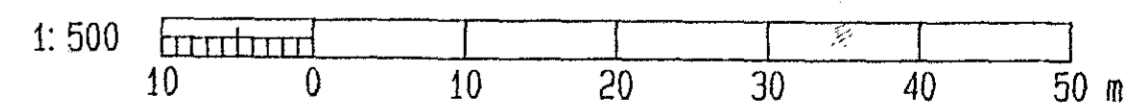
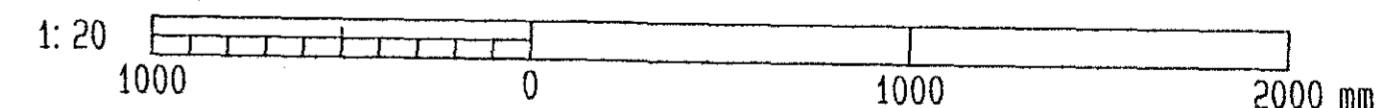
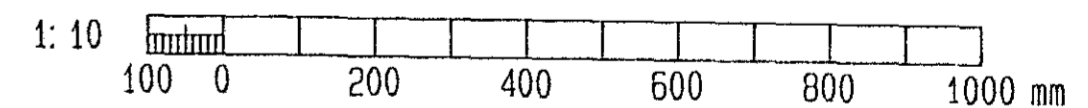
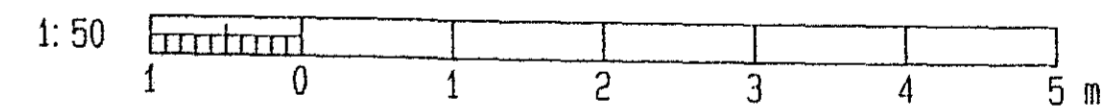
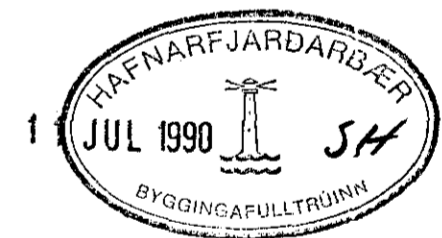

				<b>VST</b> VERKFRÆDISTOFA SIGURDAR THORODDSEN hf. VERKFRÆDIRÁÐGJAFAR FRV				<b>HAFNARFJARÐARBÆR</b>								
				108 Reykjavík, Ármúli 4 Sími: (91) 8 44 99 Fjarriti: 2040 vst is 600 Akureyri, Glerárgata 30 Sími: (96) 2 25 43 Póstfax: 680144 310 Borgarnes, Þerugata 12 Sími: (93) 7 13 17 400 Ísafjörður, Hafnarstræti 1 Sími: (94) 37 08				VATNSVEITA - VIRKJUN STJÓRNHÚS - LAGNIR RÆSILÖGN								
Teikn.nr.	Tilvísun á teikningu	Br.	Dags.	Eðli breytingar	Br.	Yf.	Samþ.	Hannað	ÓB	Teiknað	EN	Yfirfarið	Samþykkt	Dagsetning	Verk nr.	Teikn. nr.
													<i>Olof Bjarnason</i>	JUNÍ 1990	88.222	12.03