

BITI B2 40.35 1:50

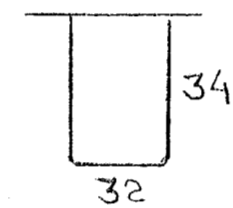

φ8 L=200 25 STK

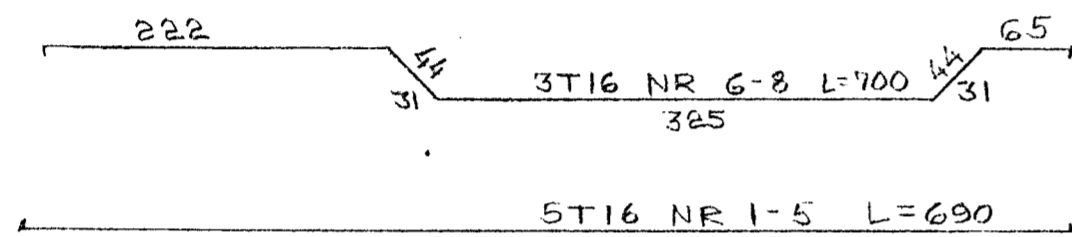
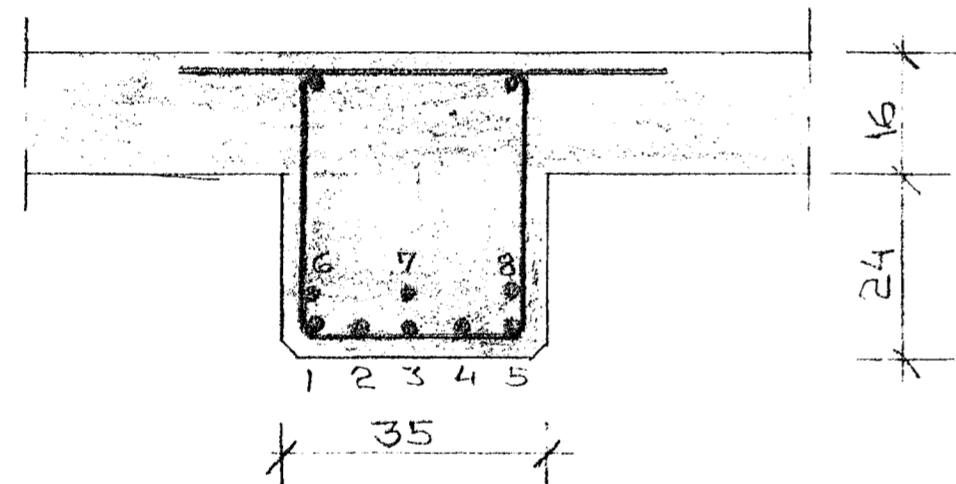

1:10

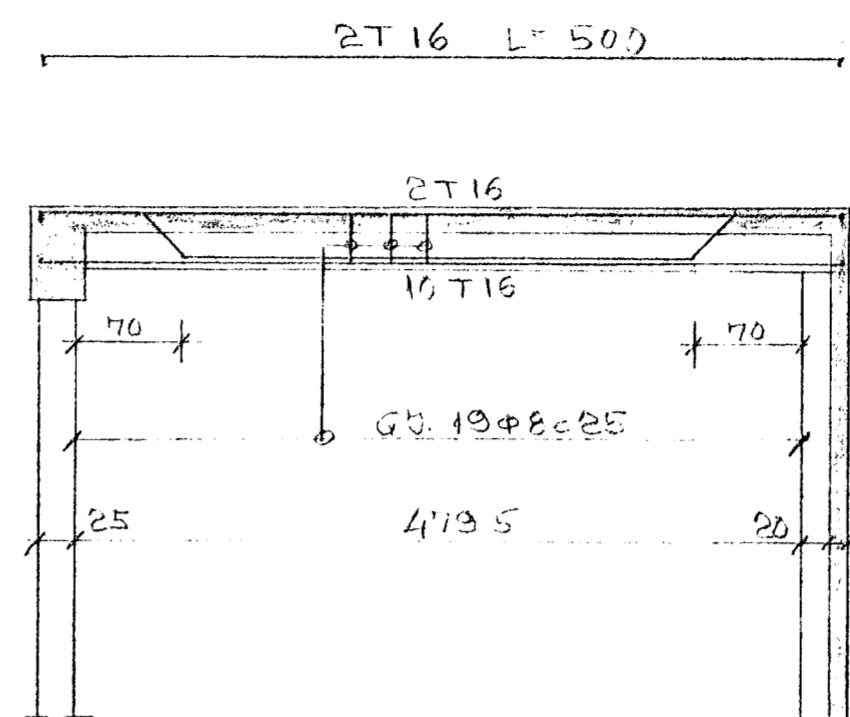

BITI R3 40.35 1:50

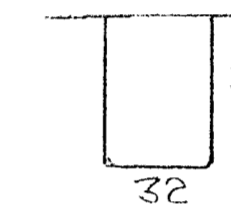
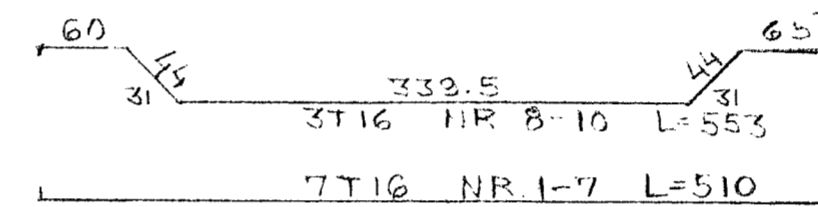

φ8 L=200 19 STK

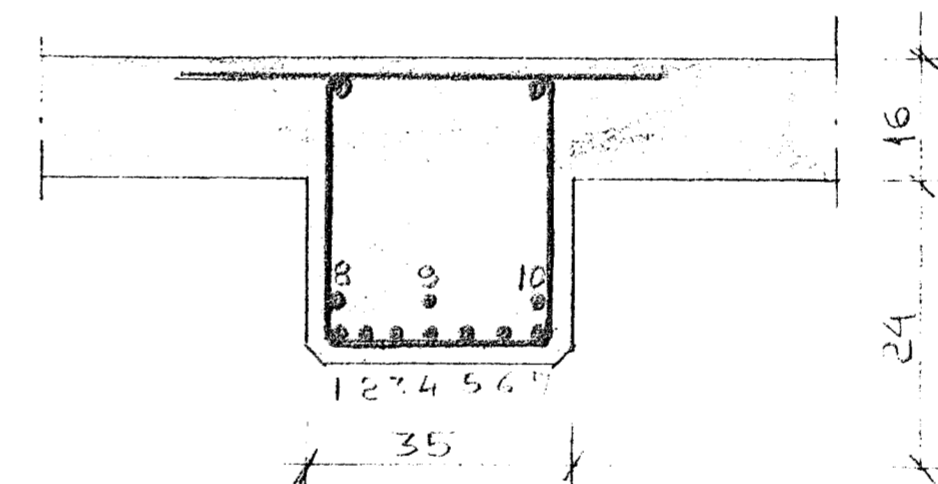

1:10

KALANG 6T16 2T16 L=225
 (TAMBAH SPALANG 2000)
 SPALANG SPERT 2T16 400

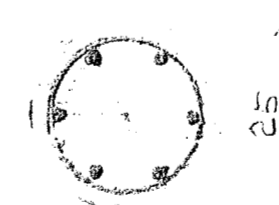

52 110

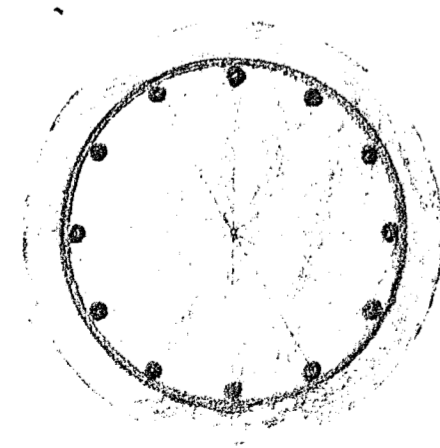

S1 1:10

KALANG/REIN 12T16
 SPALANG φ1000
 UTAMAL SPERT 2T16 400
 SPALANG SPERT 2T16 400

STRAIL-GATA 31 HAINAPIT

BLAD 7 BITAN 01 STOK 2017

HAINAPIT MAJ 160

Byron B. de Koster
Arhitek

BYGGNINGSVERKTEKARBILNAR