

SNID 8-8 Í PAKVIRKI 1:10

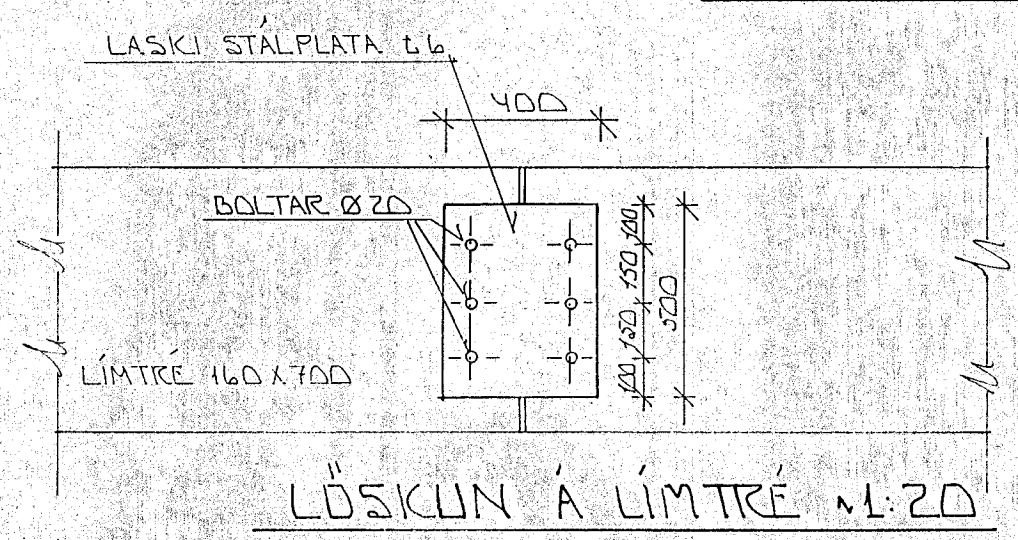

LÖSICUN Á LIMTRÉ 1:20

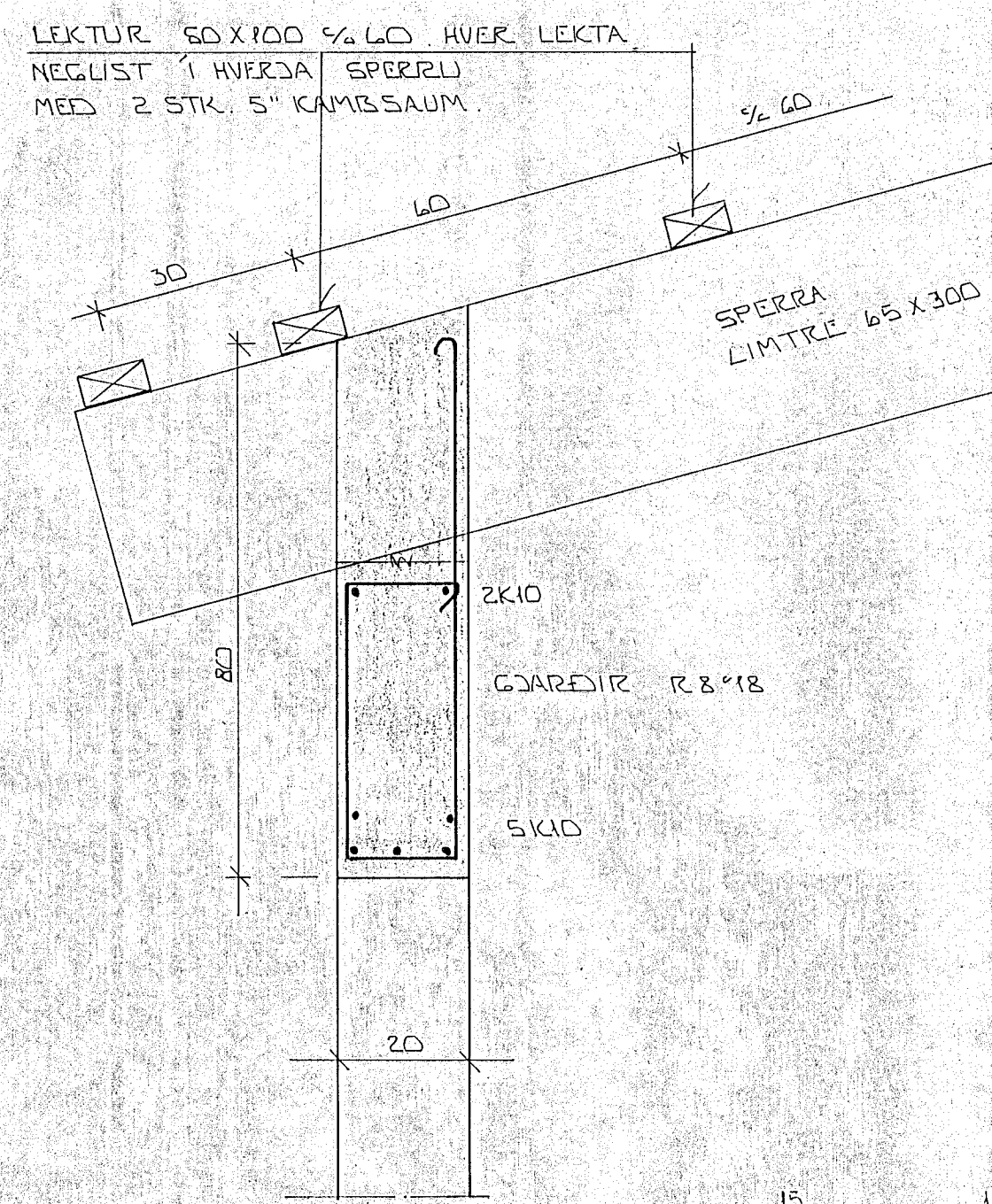
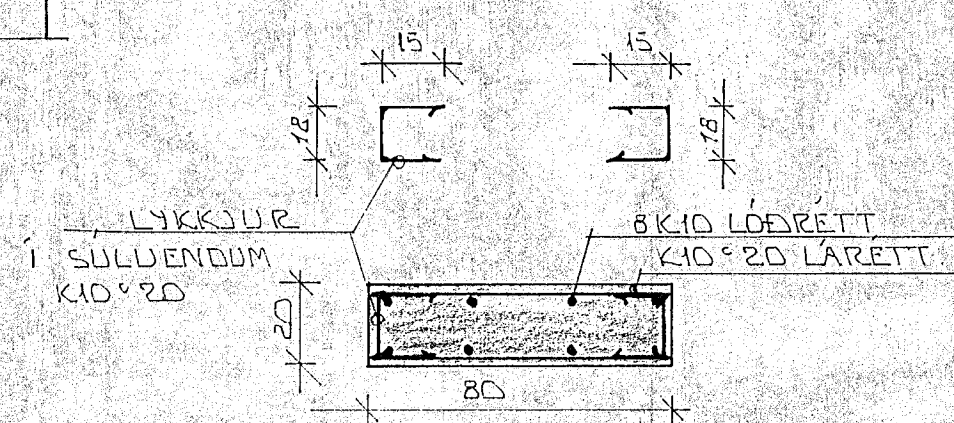

SNID Í SÚLU S1 1:20 (ÚTVEGGJUM) 1-03

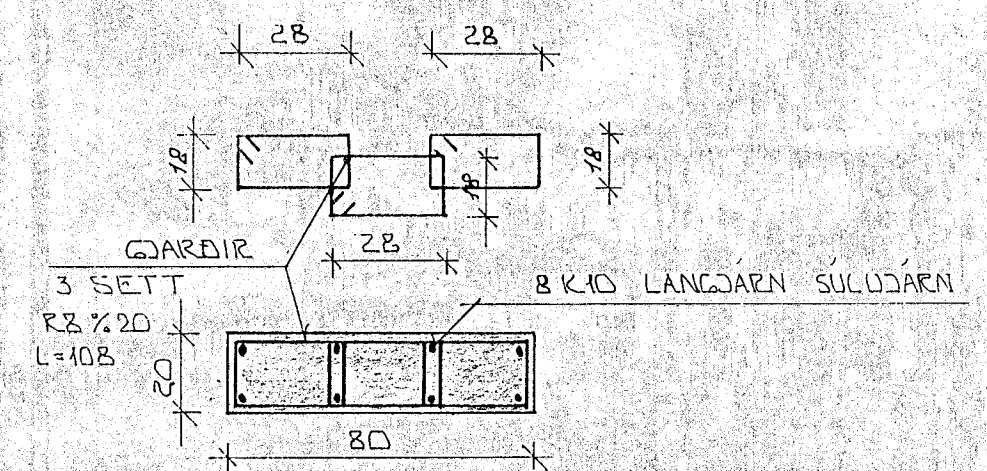

SNID Í SÚLU S2 1:20 (INNVEGGJUM) 1-03

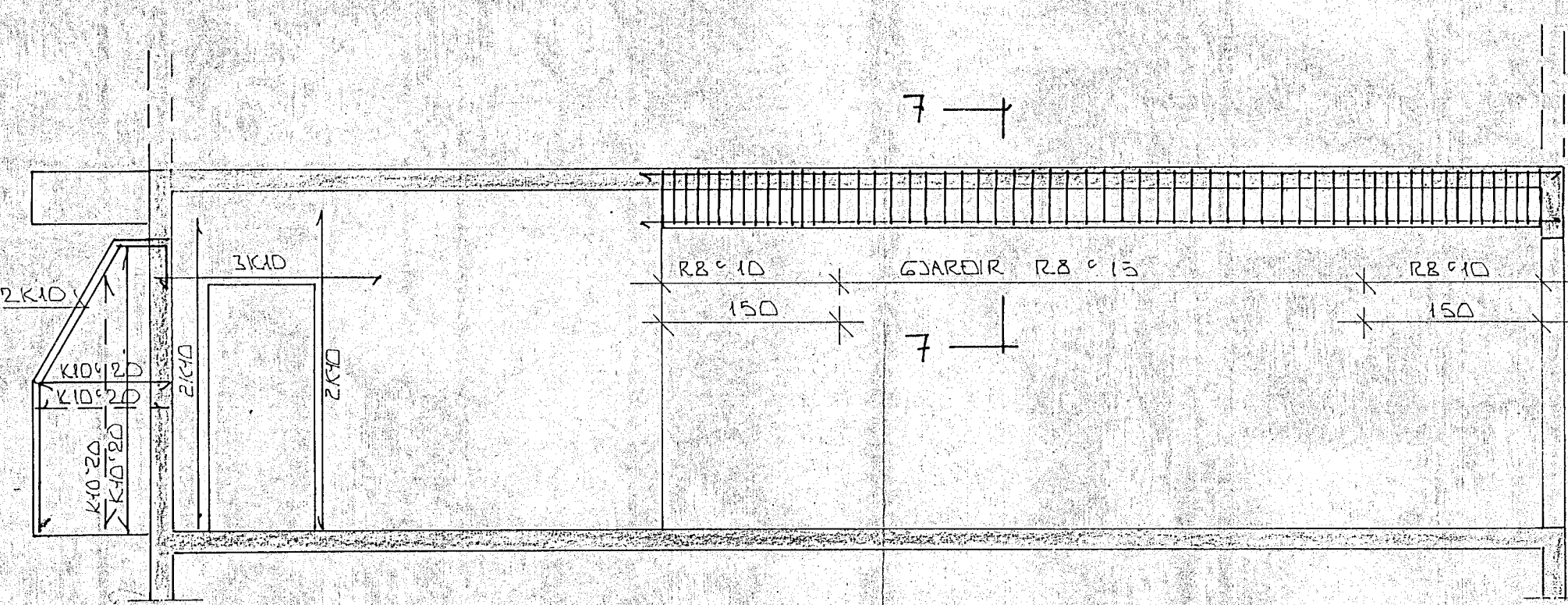

SNID 5 1:50 1-03

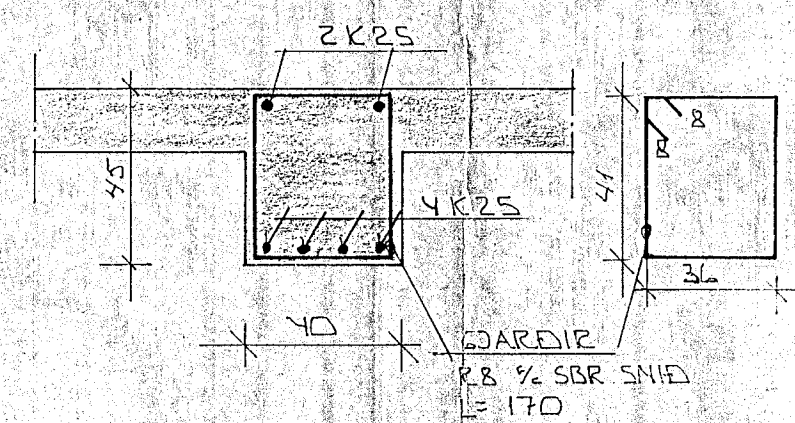

SNID 7-7 Í BITA 1:20 1-03

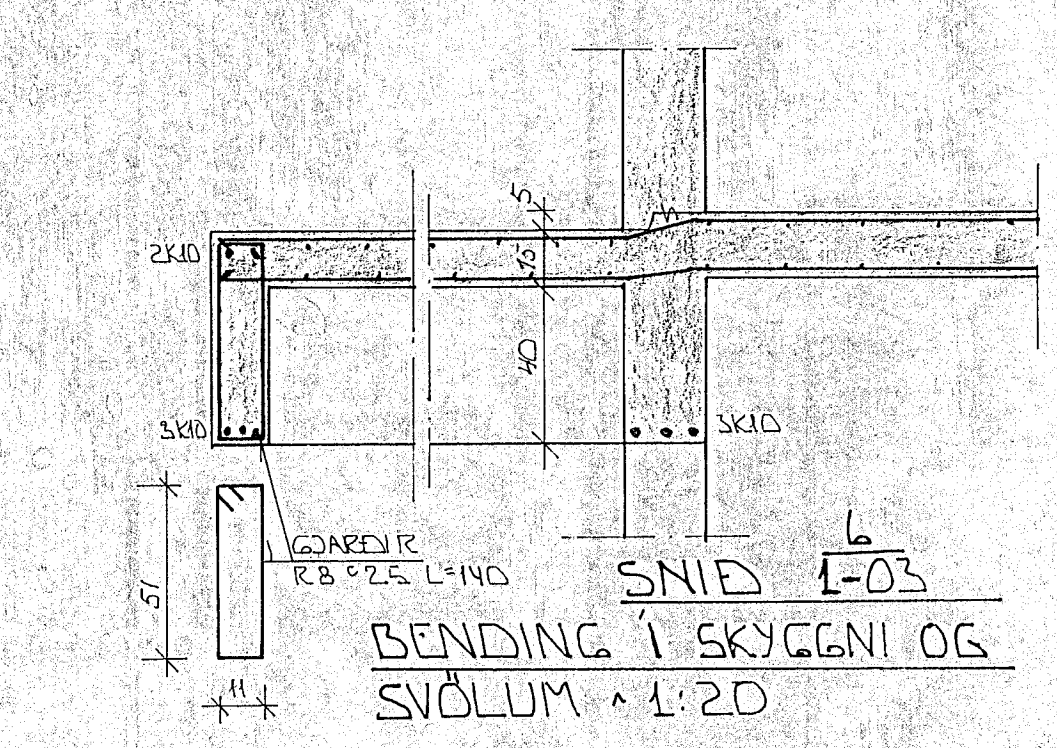

SNID 1-03 BENDING Í SKYGGNI OG SVÖLUM 1:20

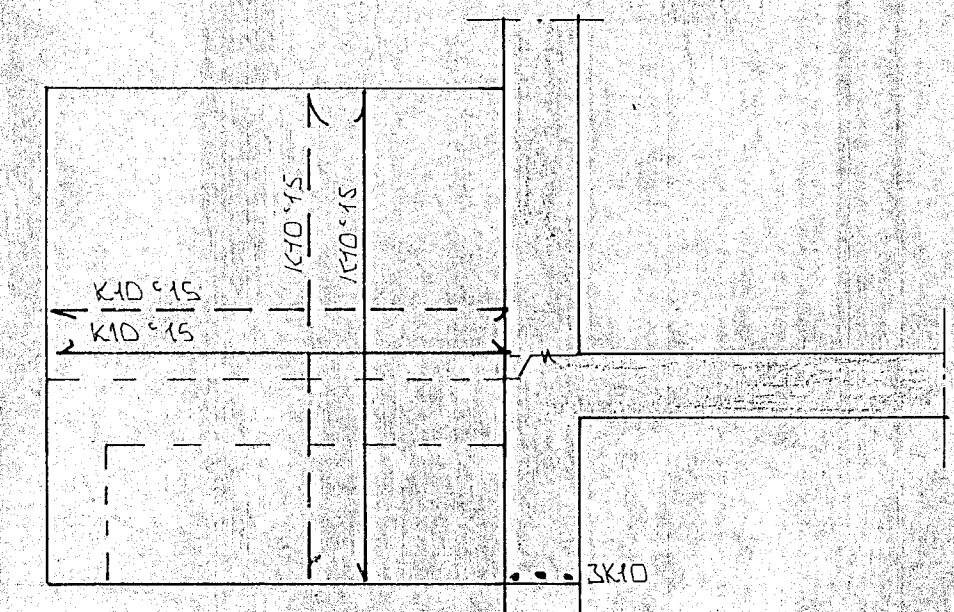

BENDING VEGGJA Í SVÖLUM 1:20

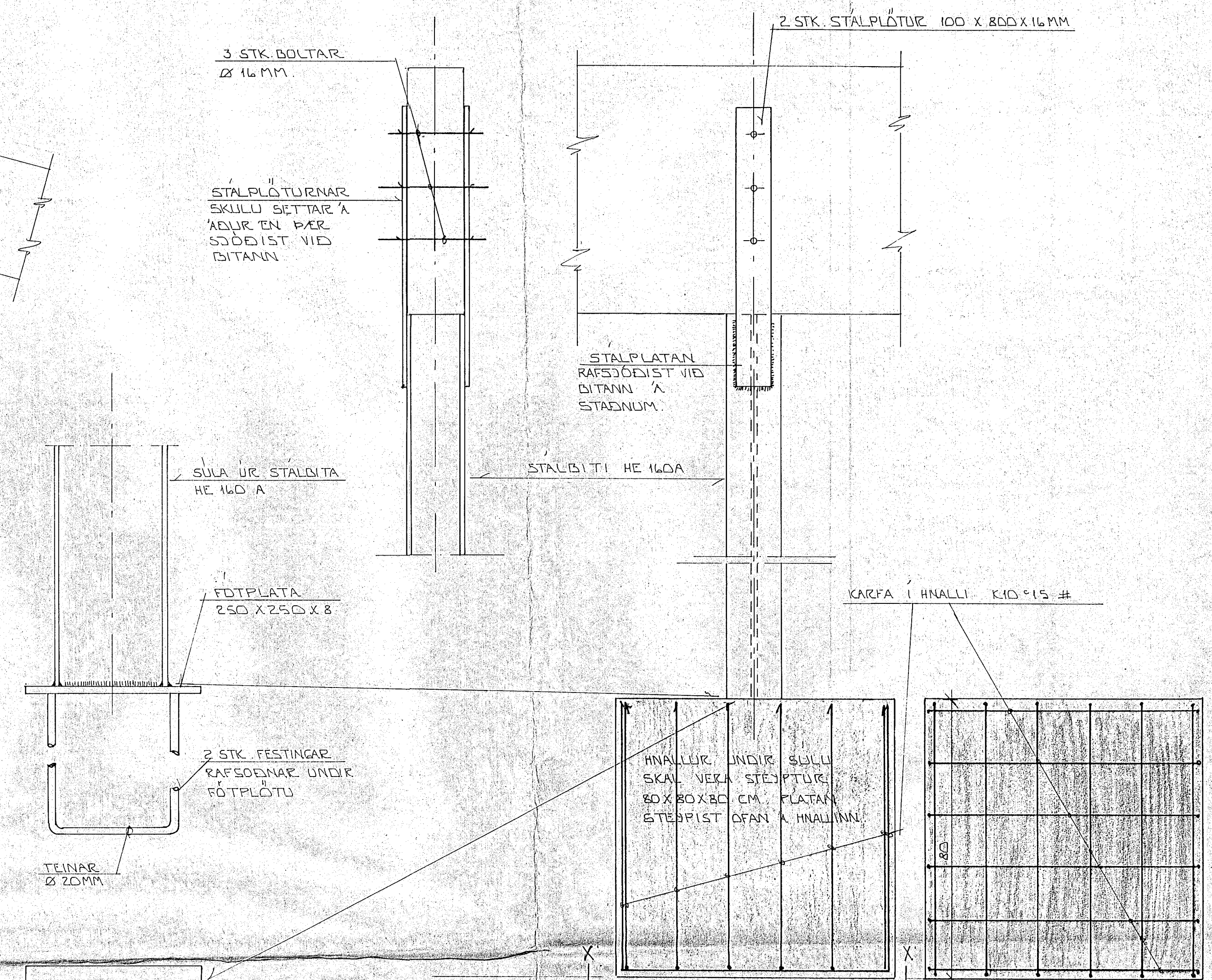

FESTING STÁLSÚLU 1:10

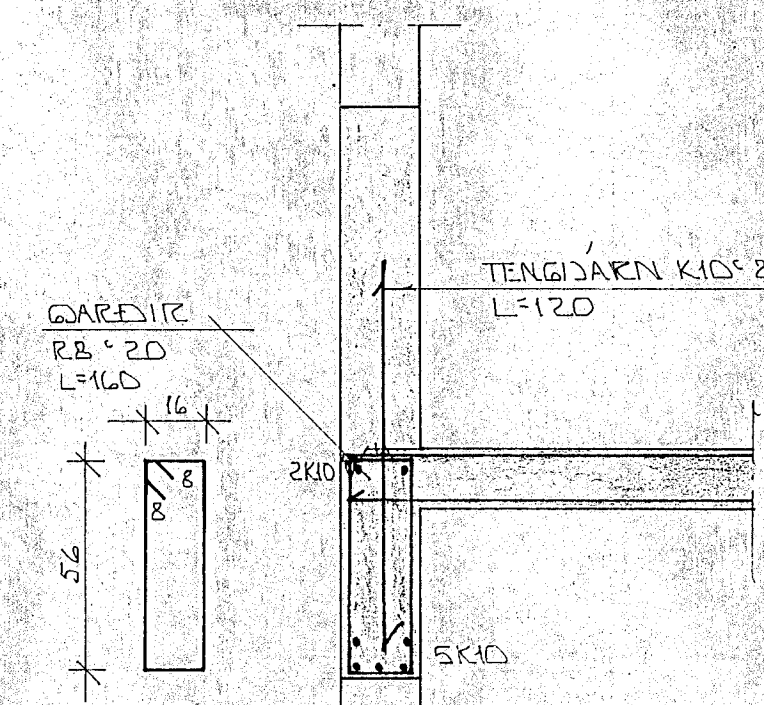
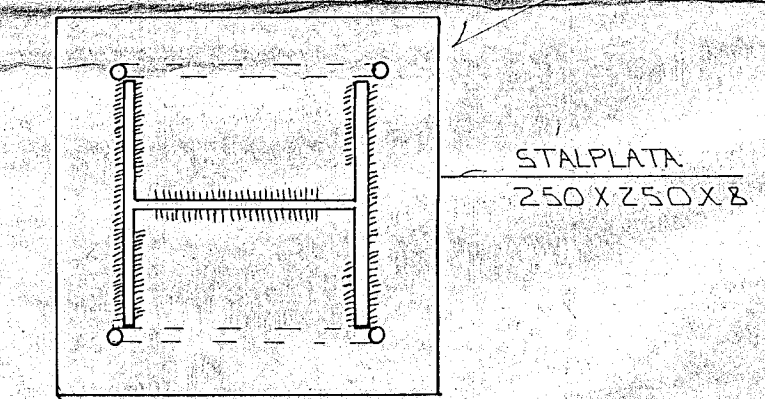

SNID Í BITA YFIR GLUGGUM 1:20

SKÝRINGAR

ALMENNAR SKÝRINGAR SÁ BL. 1-01 GRUNNMYND BURÐARVIKKIS SJA BL. NR.

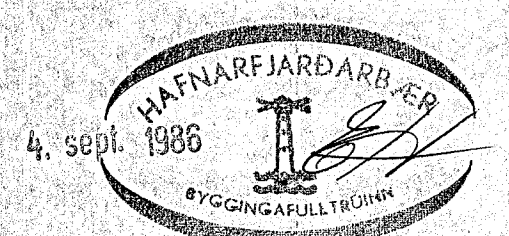

BR. NR.	DAGS	EDLI BREYTINGAR	SIGN.
STAPAHRALN Í HAFNARFIRDI			DAGS
BURÐARVIKKI YFIR 1. HÆÐ: SÉRMYNDIR.			TEIKNAD
			VERK NR. 8529
MELIKV. 1:50 1:20 1:10			BLAD NR.
SIGURÐUR ÞORLEIFSSON TEKNIFRÆÐINGUR F.T.T.F.I.			1-04
STRANDGÖTU 11 HAFNARFIRDI SIMI 54751			