

SKYRINGAR:

STEYPUVÆÐI S-160 SAMKV. ÍSL. STADLI (MINNST 300 KG  
SEMENT Í M<sup>3</sup> STEYPU) Í VEGGI, PLOTUR OG RITA.  
STEYPUSTVÆRKTARSTÁL K<sub>8</sub> 40 MEÐKT -K  
9T 37 " -Ø

UNDIR OG UPPMÆD GLUGGUM KOMA 2 K 10, EINS Í VEGGENDA OG  
UPPMÆD DYPUM. YFIR DYR OG GLUGGA KOMA 3 K 10, NEMA ANNA'S  
SÉ GETID, OG GANGA JÁRNIN MINNST 70 CM ÚTFYRIR OPIN EDA  
SAMFELD YFIR FLEIRI OP.

PLOTUÞYKKT: HÖSS 15 CM

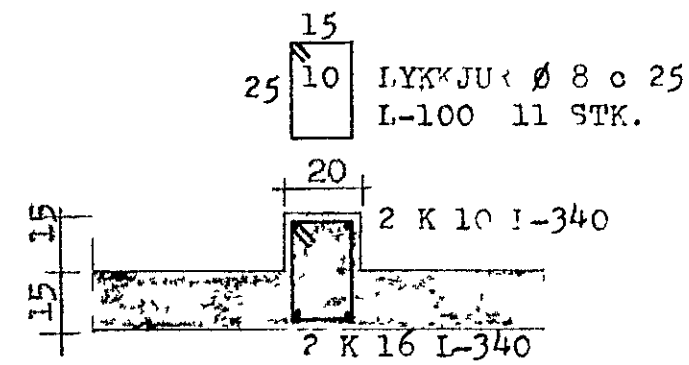

SNID - F 1:20

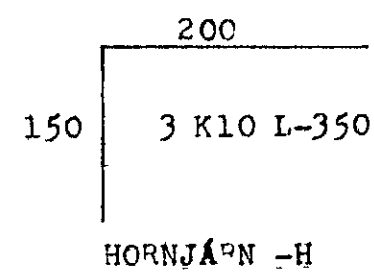

SNID - G 1:20

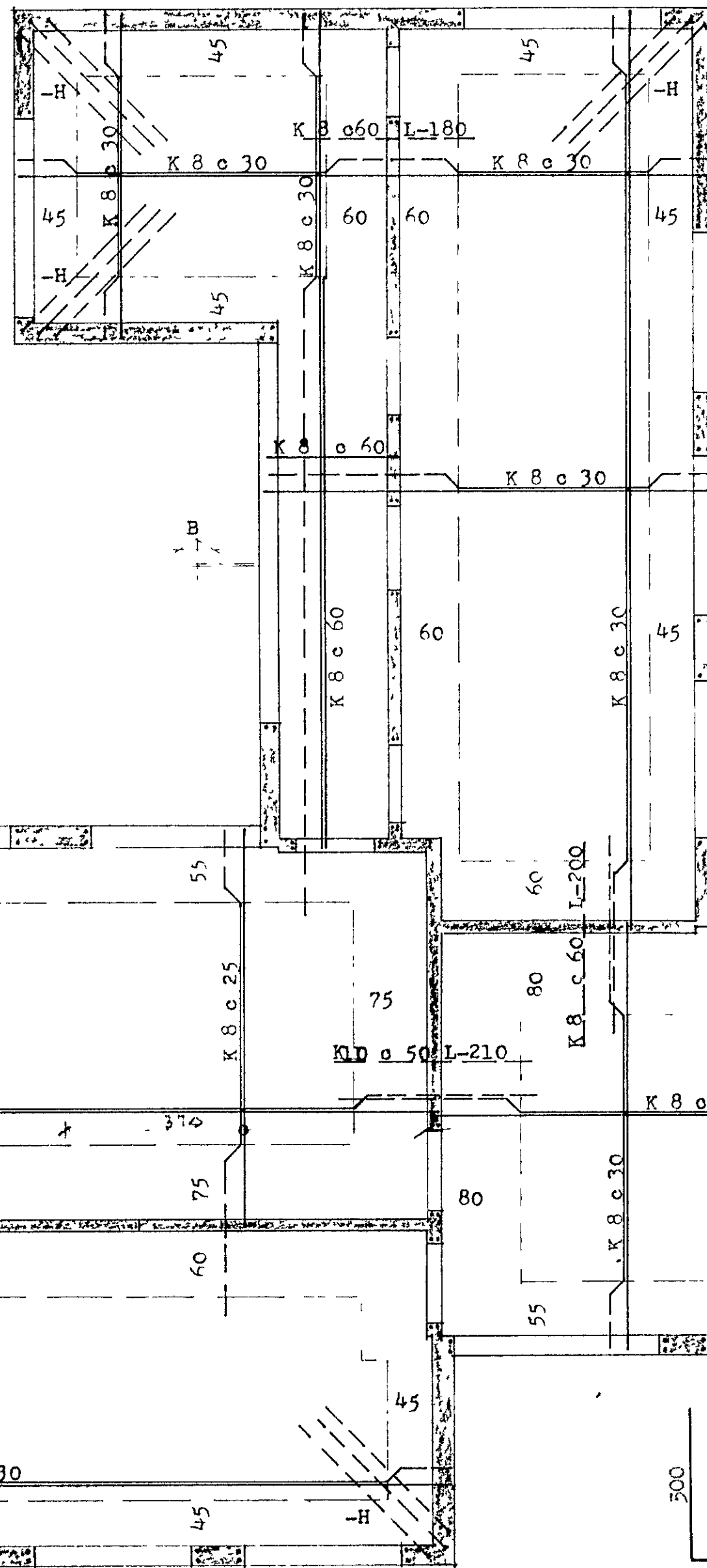

ÞEYKHÁFUR BENDIST Í ÚTBRÚN MED  
8 K 8 LÓÐRÉTT  
LYKKJUM Ø 8 c 25 LÁRÉTT  
OG EY'ANGRAST MED 5 CM H-AUNHELLUM

ANNAÐ HVEIT JÁRN  
BEYGT Í DE' I BRÚN  
PLÖTU

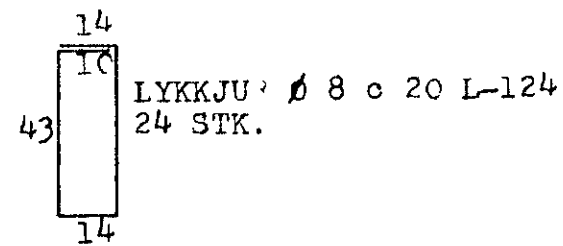

SNID - A 1:20

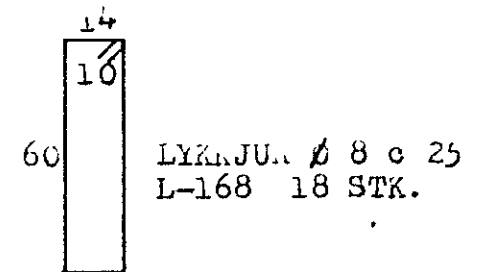

SNID - B 1:20

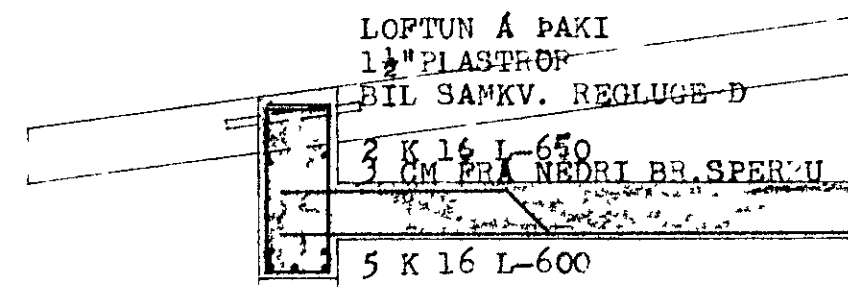

SNID - C 1:20

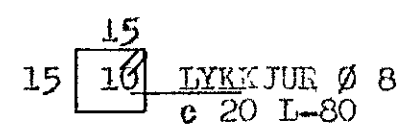

SNID - D 1:20

SNID - E 1:20

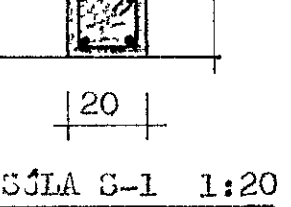

SNID - E 1:20

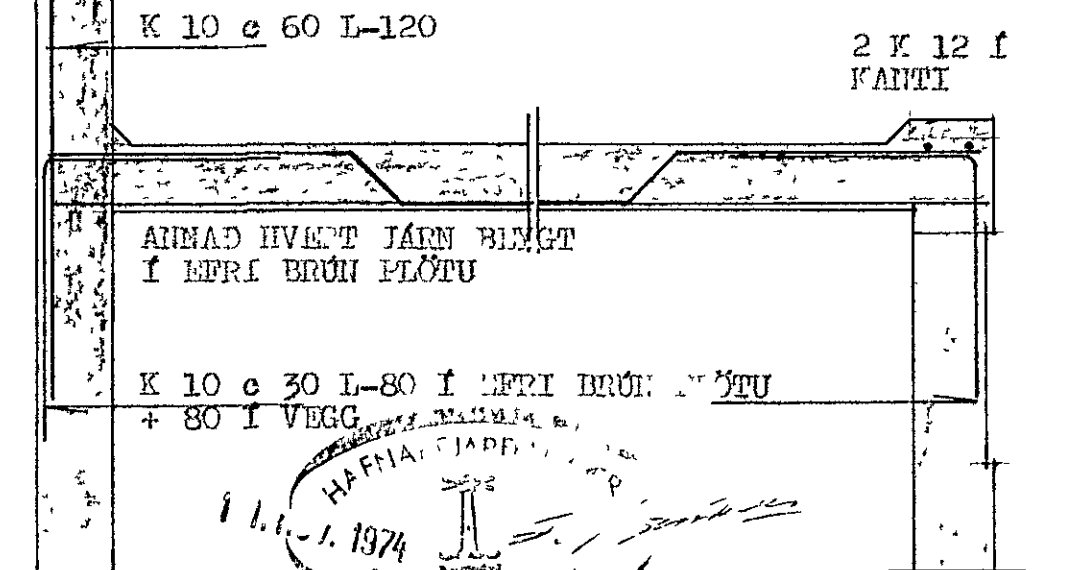

SNID - C 1:20

SNID - D 1:20

SNID - D 1:20

SNID - D 1:20

SNID - D 1:20

SNID - D 1:20

SNID - E 1:20

STEINGÍMUR TH. ÞÓRLEIFSSON MTPI		
HEIDVANGUR N. 52 HAFNARFLAÐI		
MÁL	1:20	JÁRNBEIT STEINSTEYPA
DAGS.	1:50	LOFTPLATA
	FEB. 1974	GRUNNMYND OG SNIÐ
BLAD	2	

BYGTT Í 1974 S. Þ. ÞORLEIFSSON