

Gólf skó

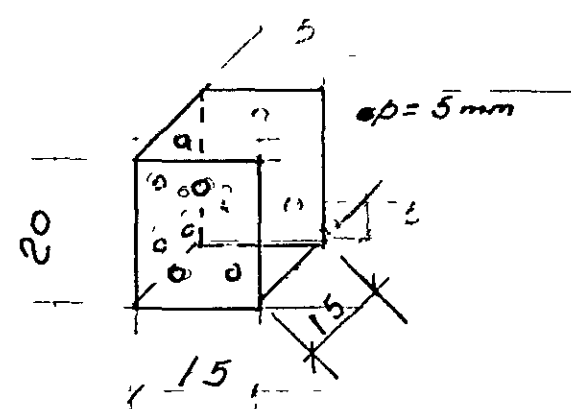

4-4
1:10

Skör
allar festingar
140x300 við 140x667

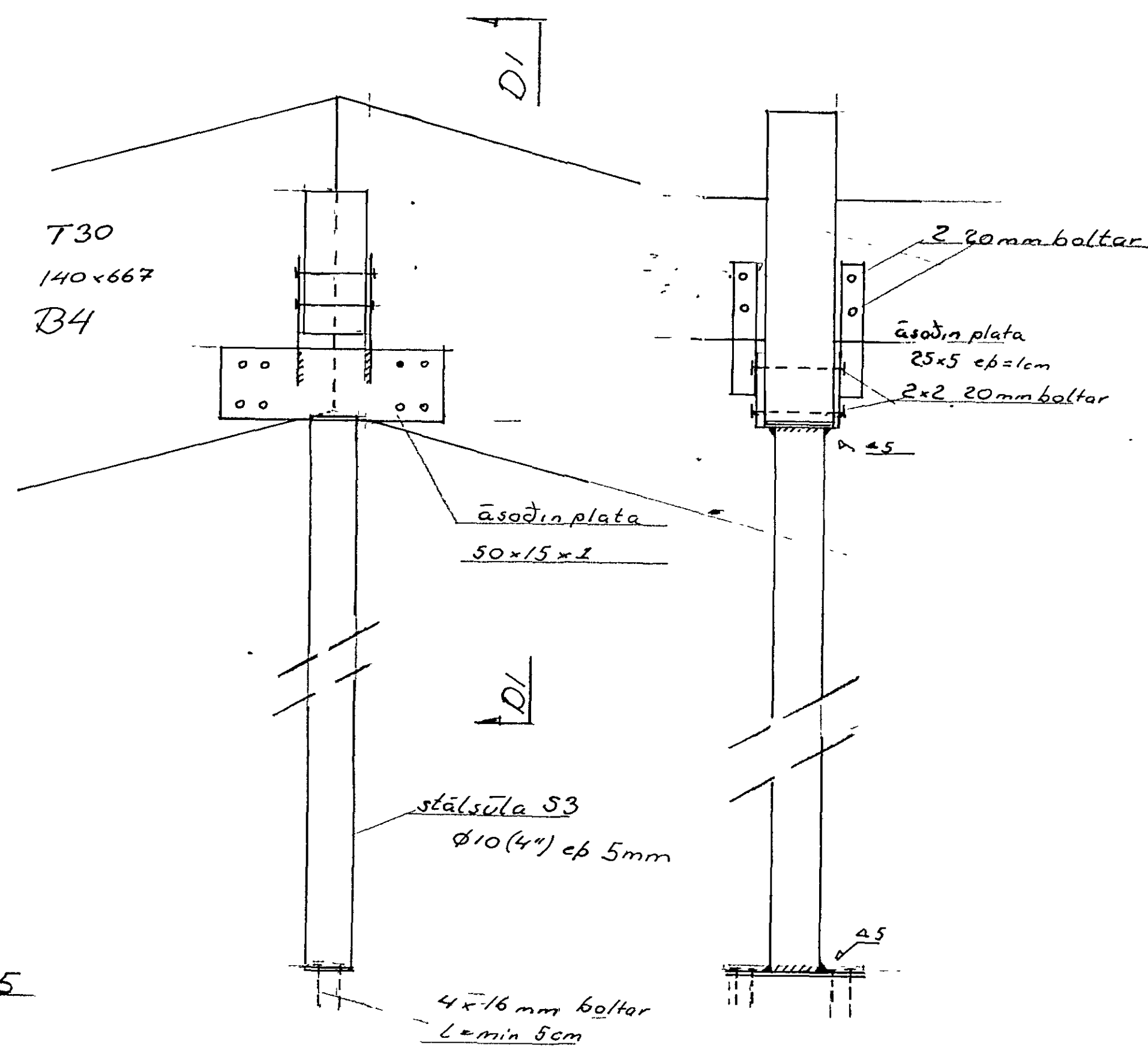
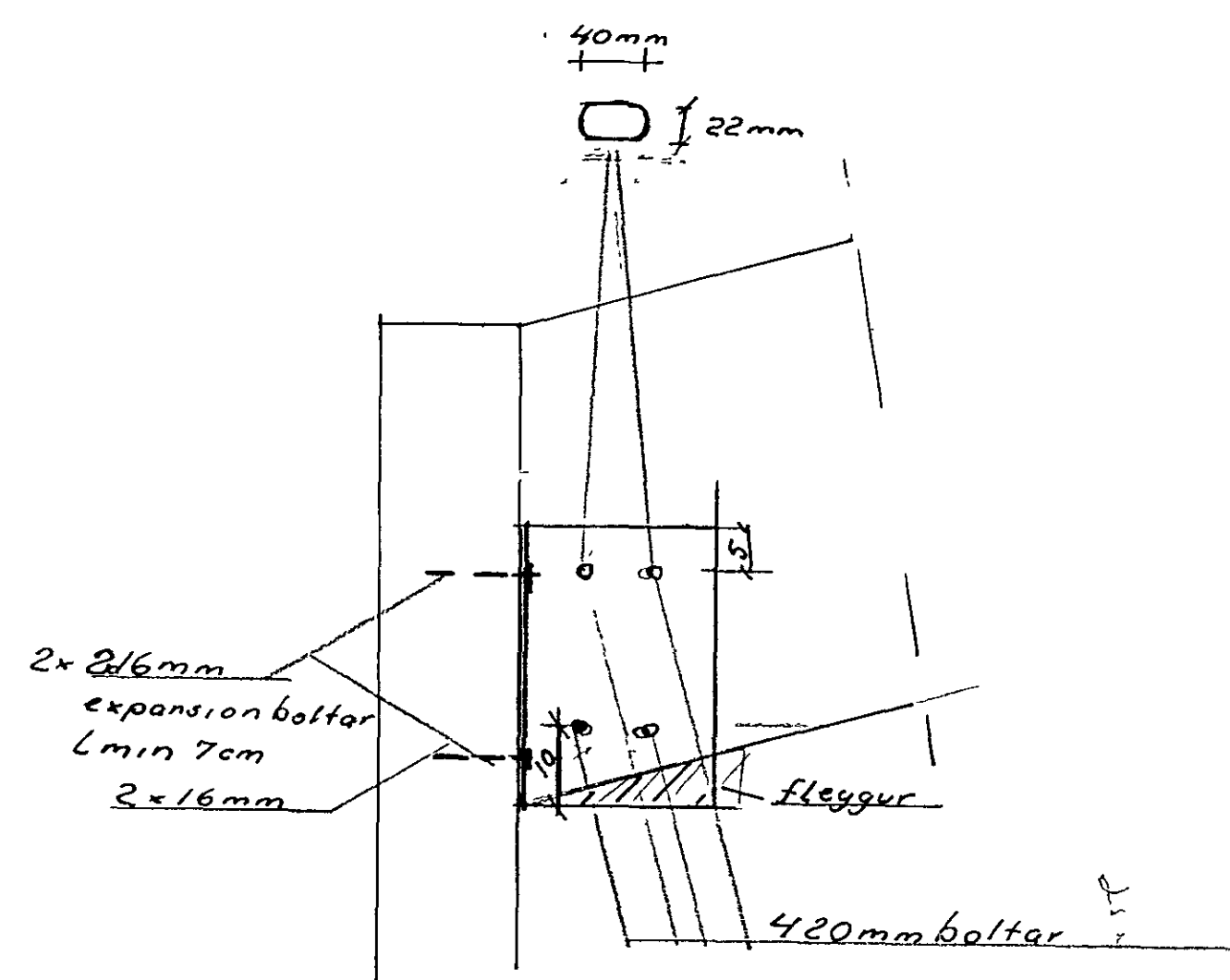
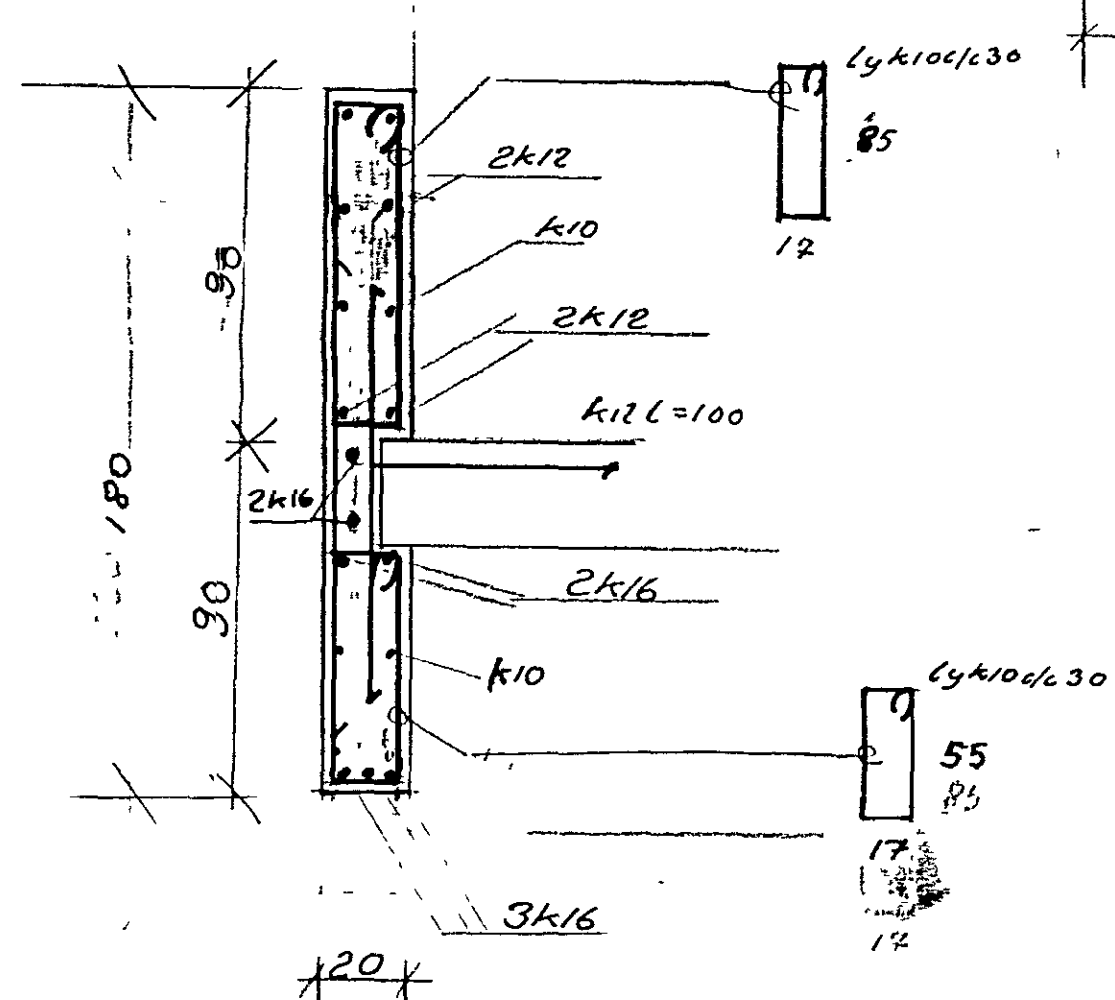

5-5
1:20

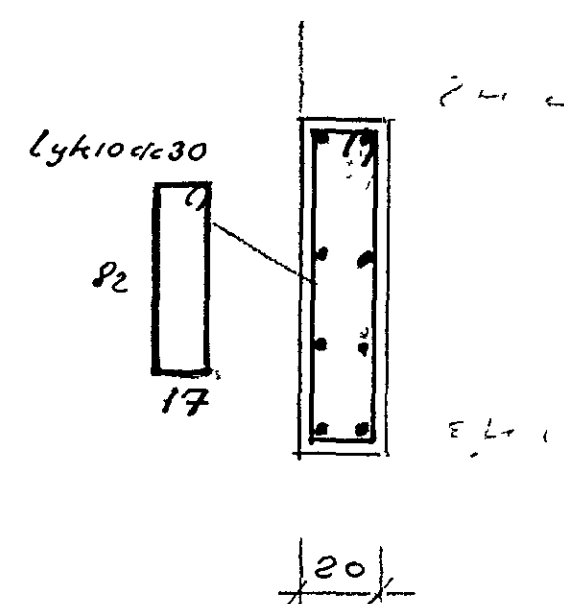

5-6
1:20

5-5
1:10

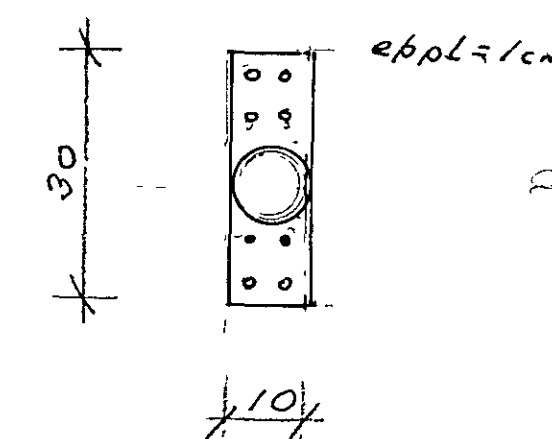

DL
1:10

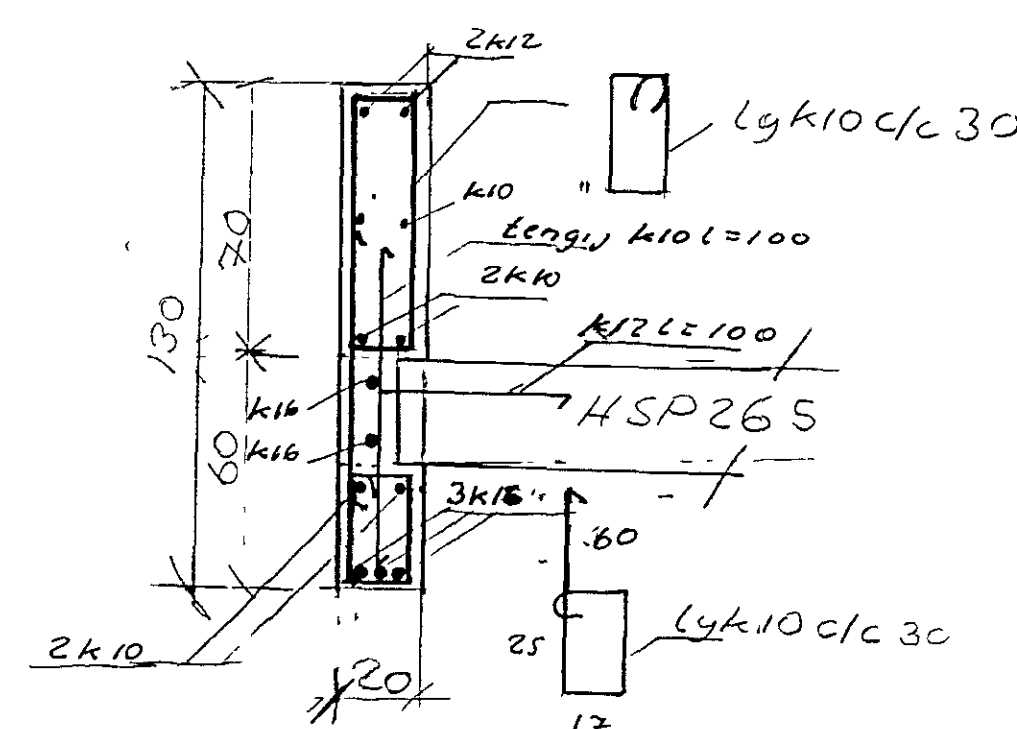

8-8
1:20

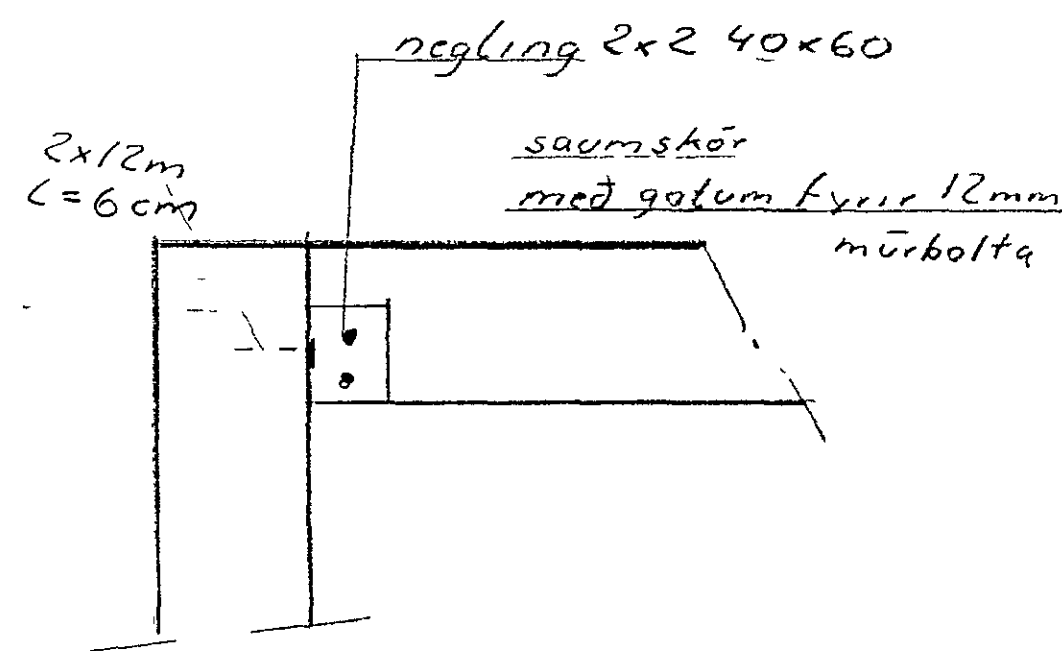

7-7
1:10

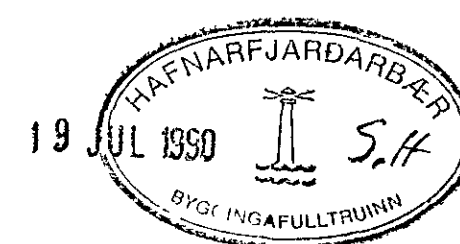

6104B		
Hvalyrararbrast 2		
	Sníð	1:10 1:20
1011 30	Byggingu- og húsnæðisráðgjafi	1980