

EINFÖLD GRIND Í VTRIBRÚN  
 LITNEGGJA  
 LÆRFT KÍD°20  
 LÖBRET KÍD°30

LASKI ÚR 16MM KROSSVIÐ ÞADUMMEGIN SPERRU  
 NEGLIST MEÐ 2x6STK 2½" NÖGLUM

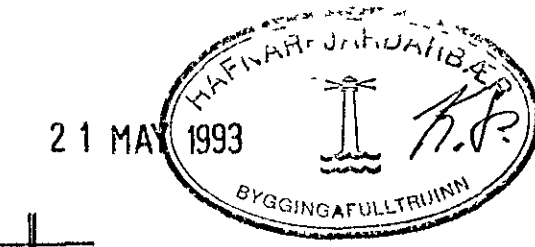

FRÁGANGUR ÞAKKAUJTS  
 SJA SERT ARC

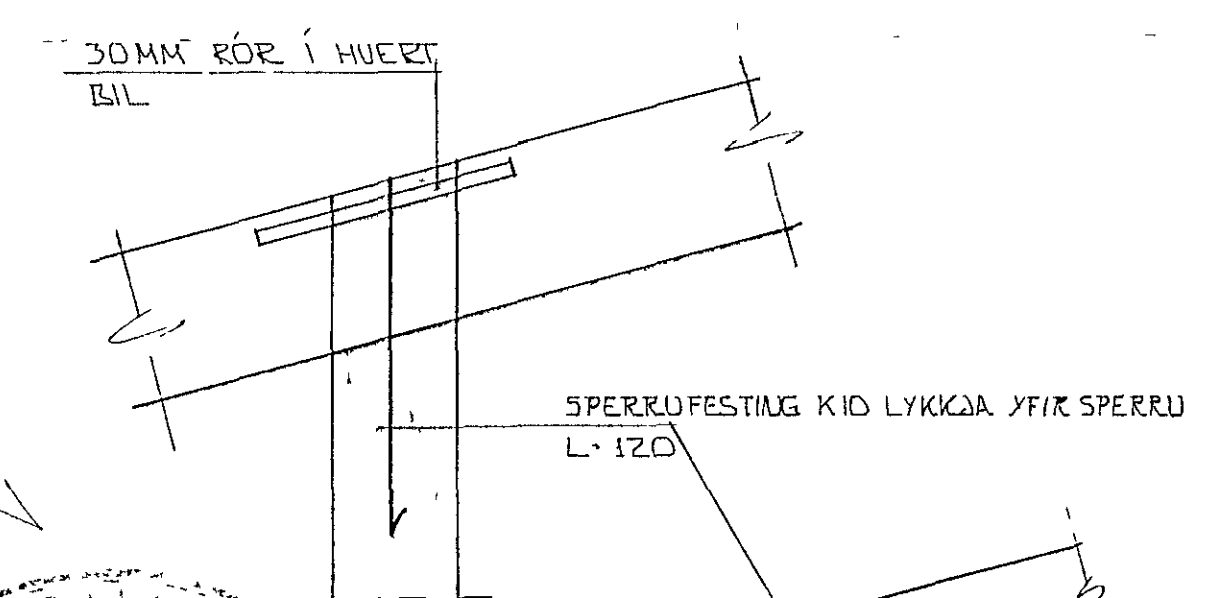
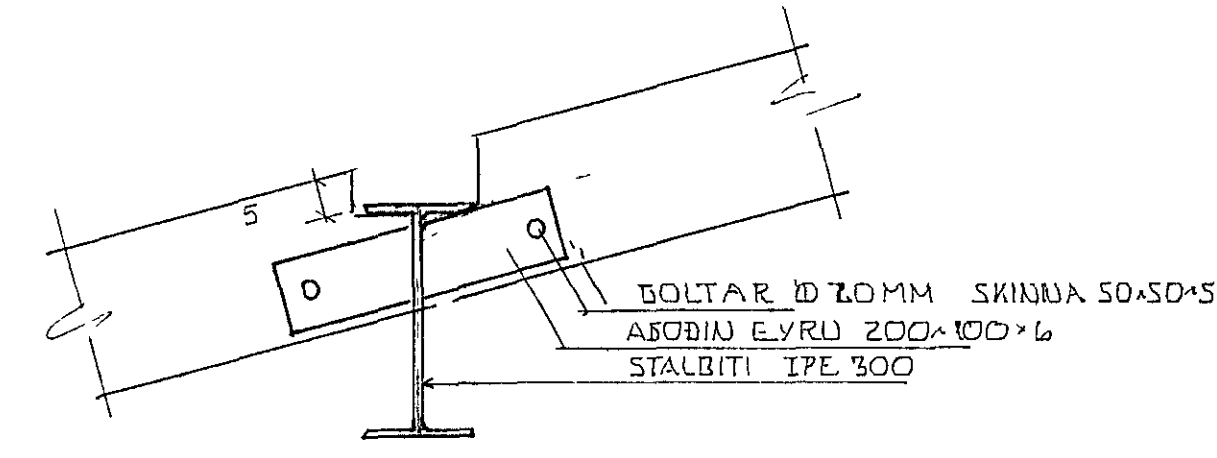
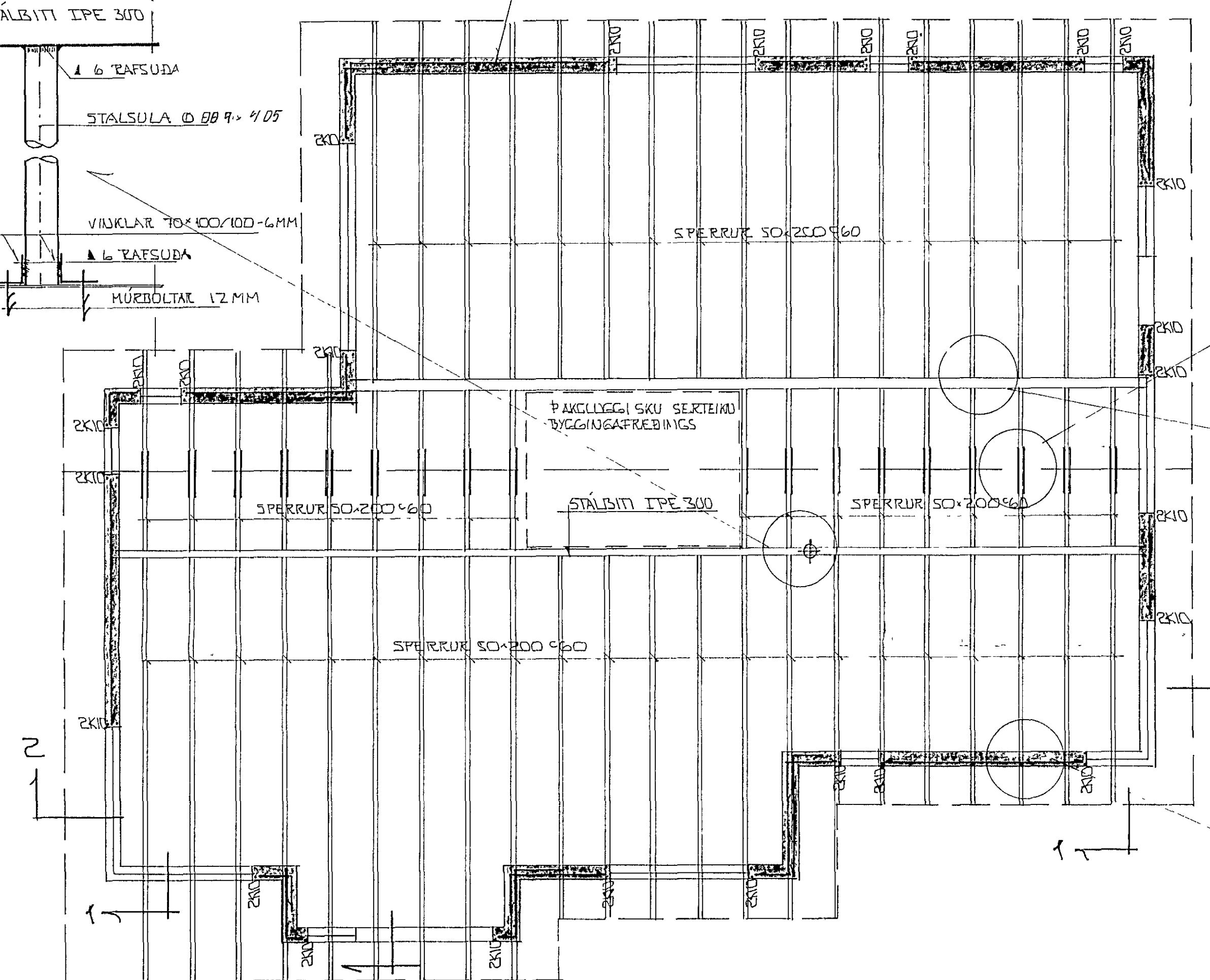
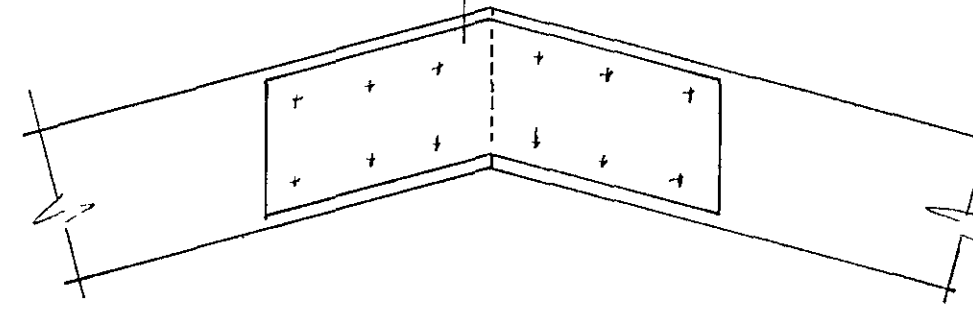
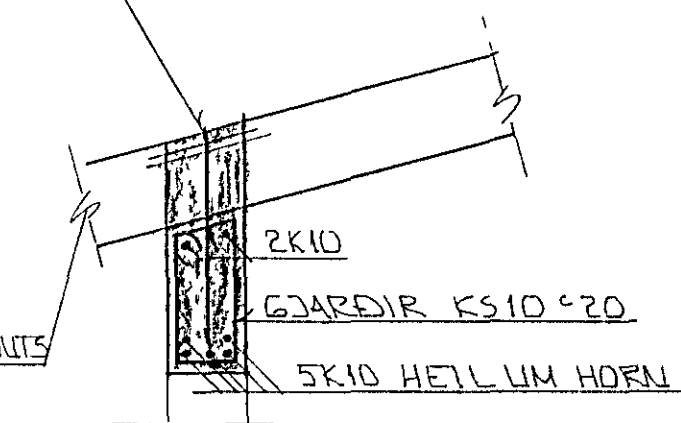

GRUNNMÝND 1:50

STEYPA:  
 S > 250  
 VS ≤ 0.5  
 LOFT ≥ 6%  
 SEMENT ≥ 300 KG/M<sup>3</sup>

ÁSKILIÐ, ELÐRI  
 TEIKNING ÓGILD

SNÍÐ 1:1:20

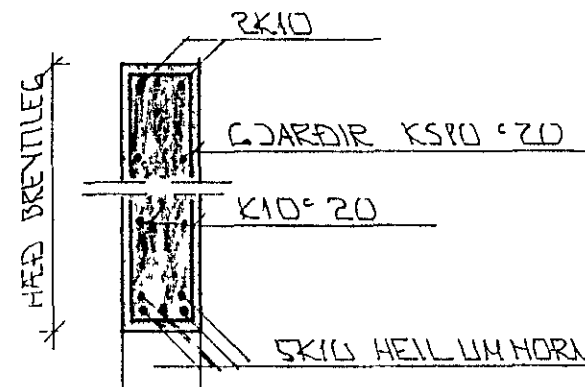

SNÍÐ 2:1:20

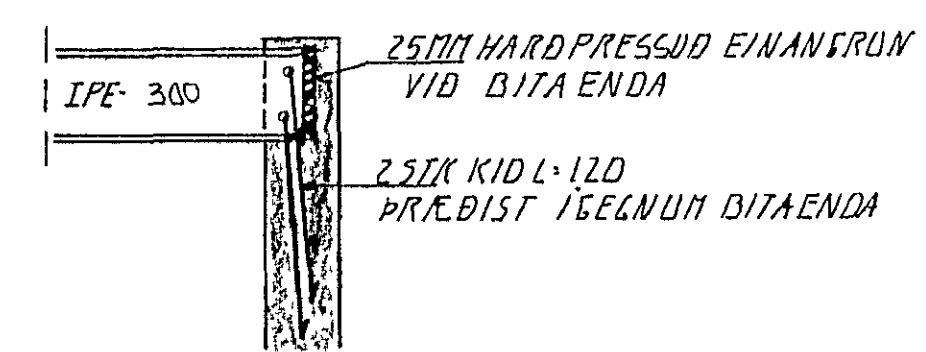

ÞITA ENDI Í VEGG 1:20

SKÝRINGAR  
 ALMENNAR SKÝRINGAR SJA BL NR 1-01.

BR NR	DAGS	EDLI BREVINGAR	SIGN
02	APRIL 93	SNÍÐ Í ÞITA BRESTI	g.f.
01	DES 92	ÞÆTTI VÍÐ SMÍÐUM	g.f.
LÆÐARBERG 11 HAFNARFIRÐI			DAGS/
BENDING VEGGJA 2 HÆÐAR			HANNAÐ
ÞAKVIÐRI			TEIKNAD
MELIKV. 1:50 + 1			VERK NR
SIGURÐUR ÞORLEIFSSON TEKNIFRÆÐINGUR F.T.F.I.			9159
STRANDGÖTU 11 HAFNARFIRÐI SÍMI 54751/54255			BLAÐ NR
			1-05