

Sambýkt þann
 05. mars 2021
 F.h. byggingarfulltrúans í Hafnarfirði
 Sigurður Steinar Jónsson

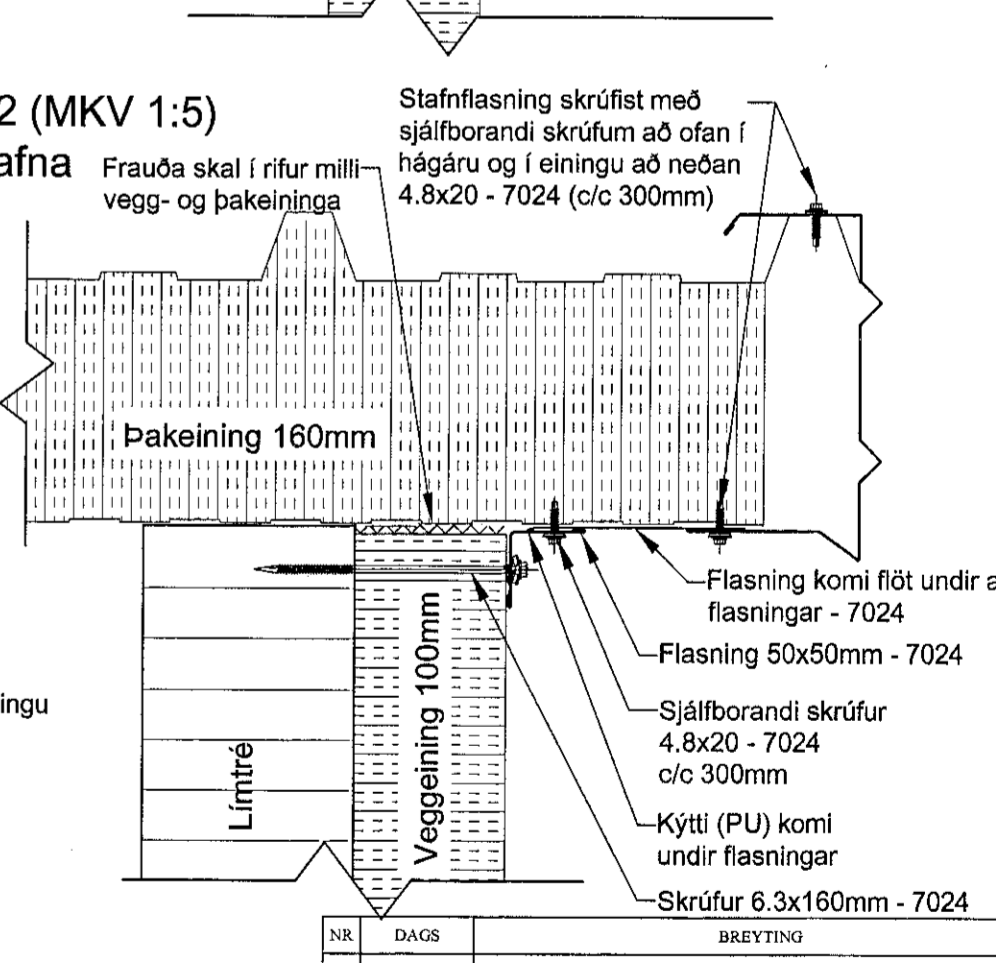
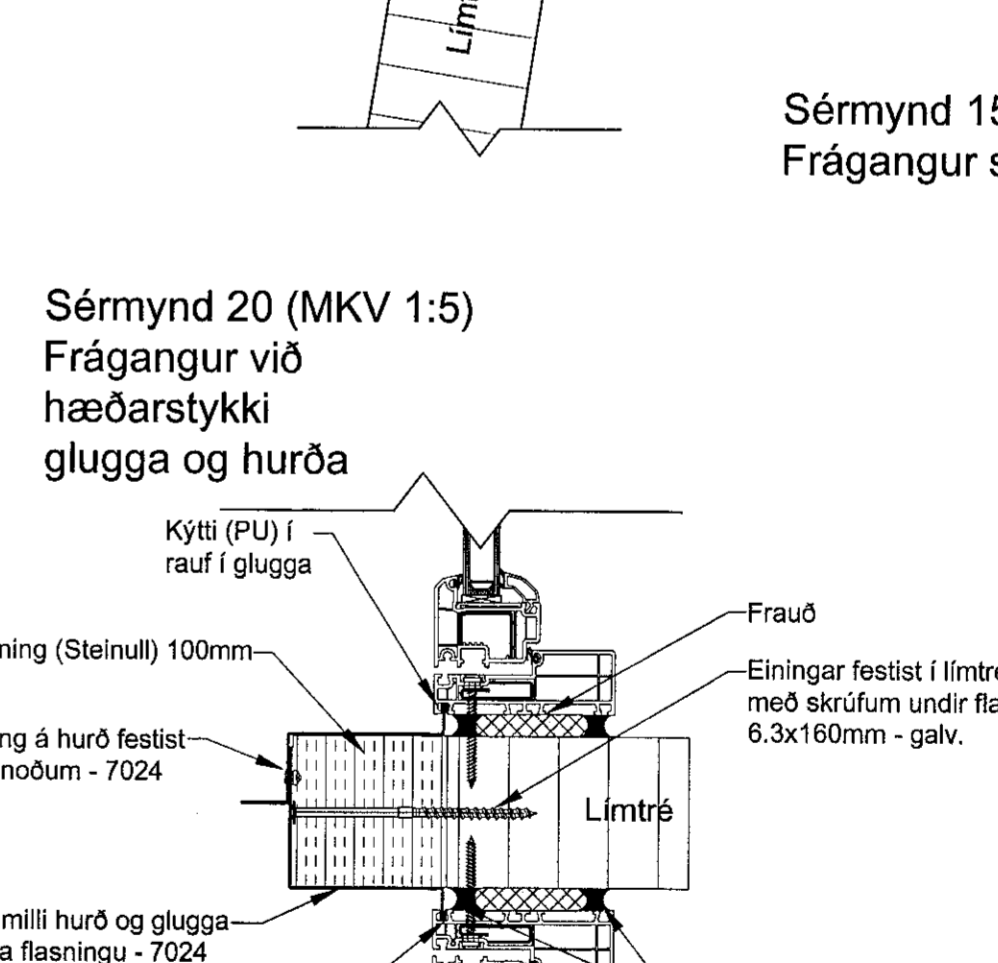
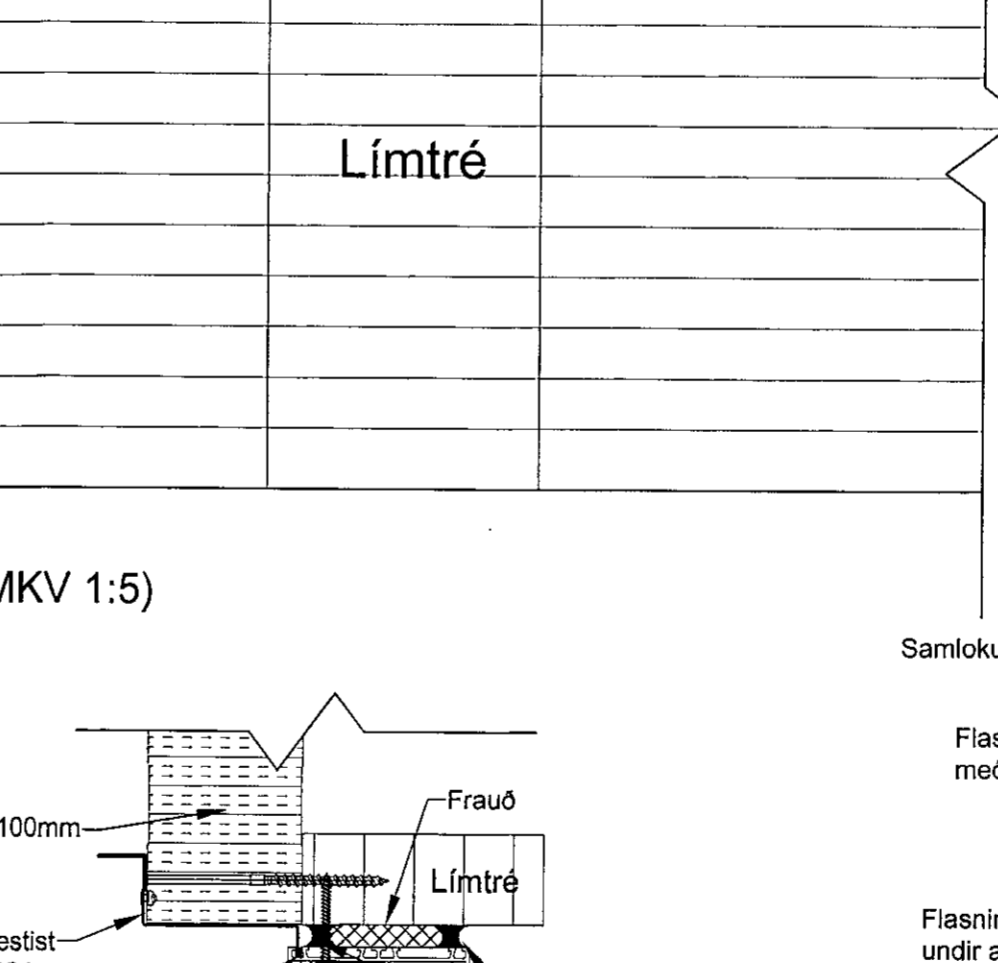
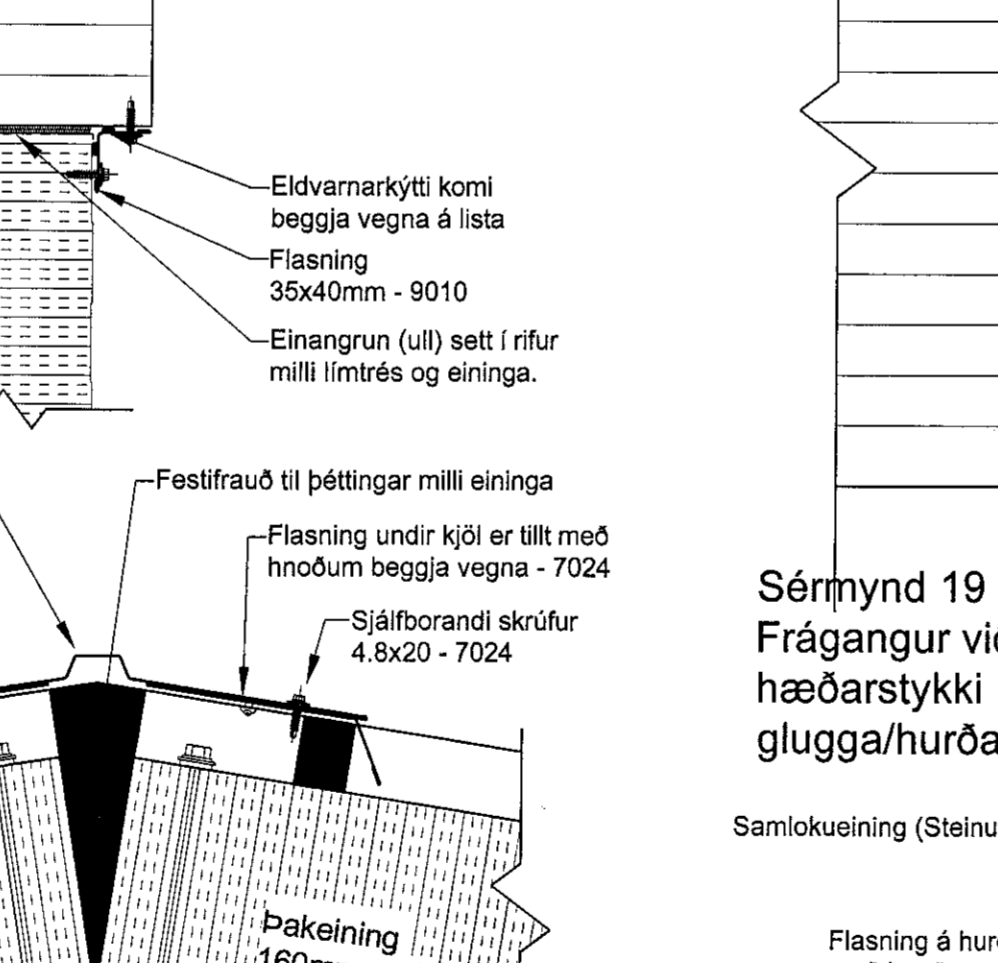
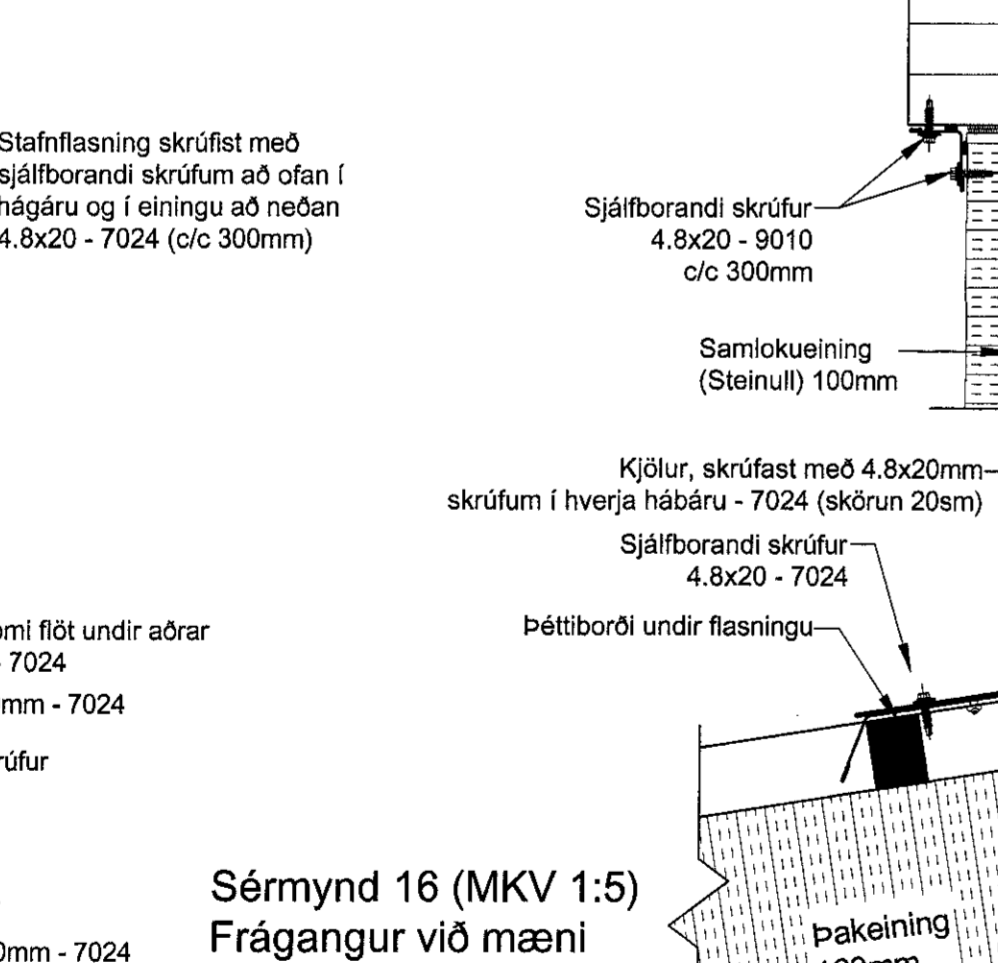
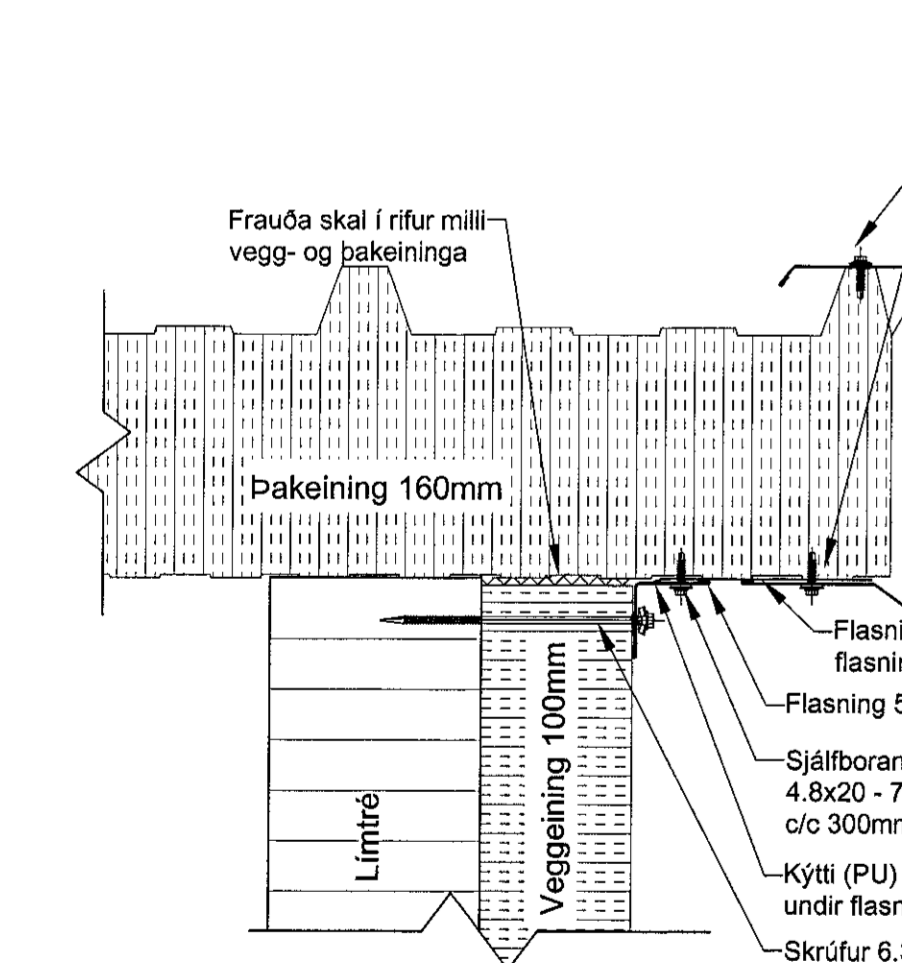
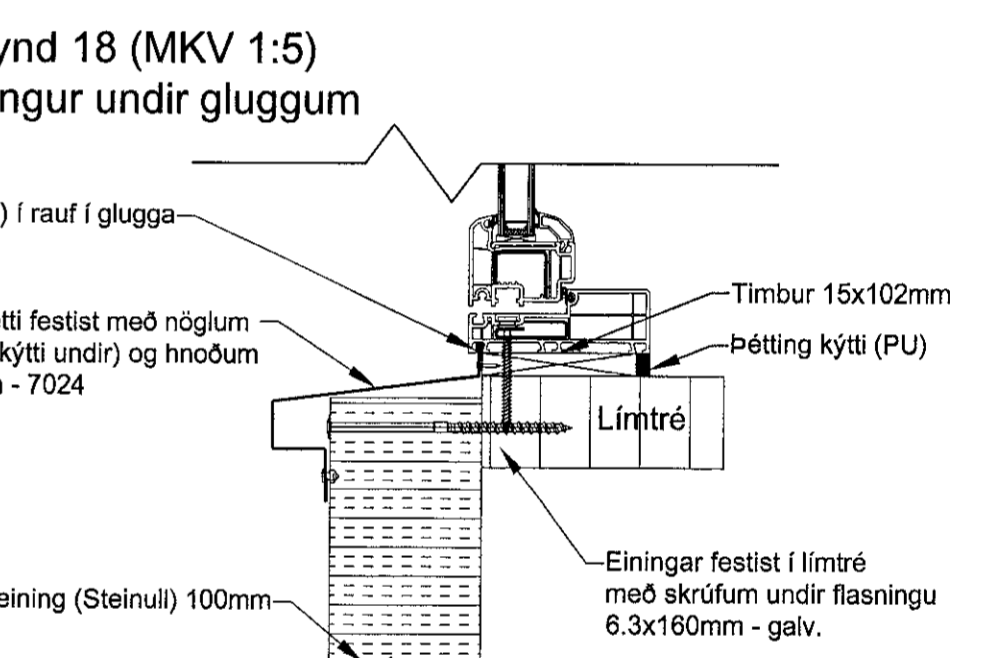
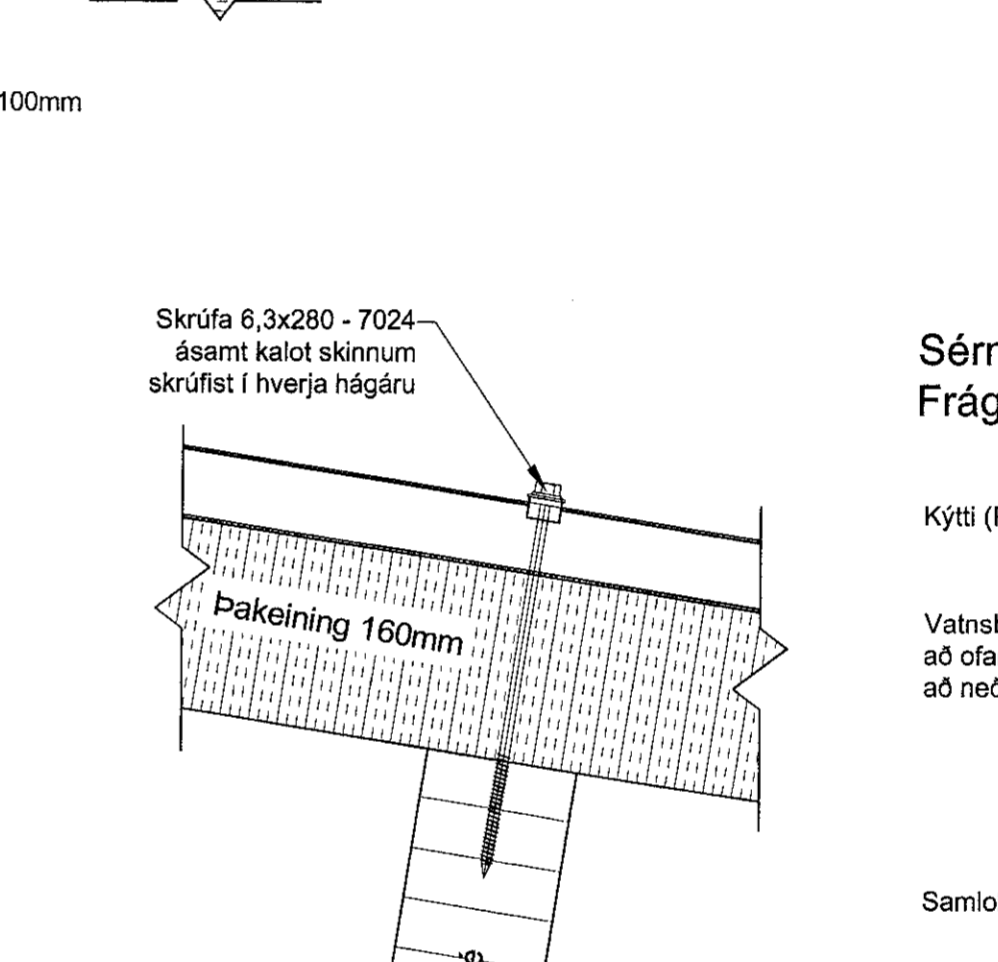
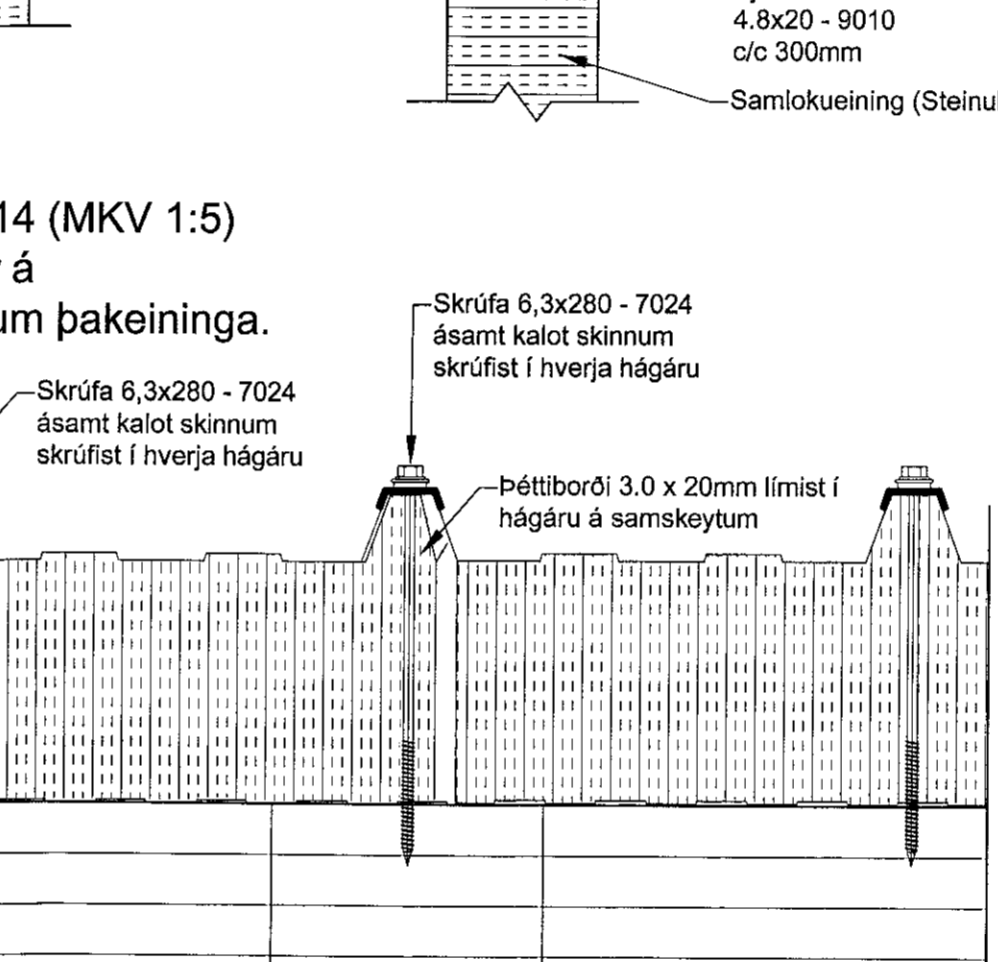
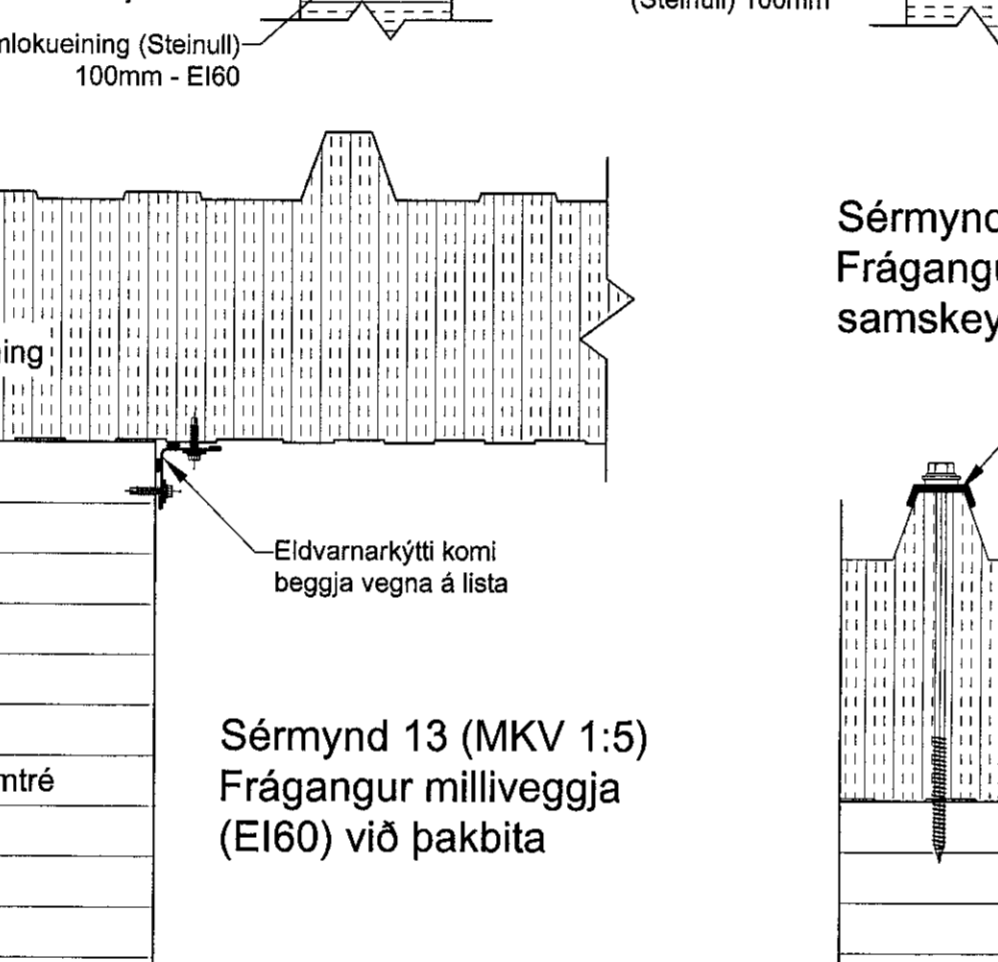
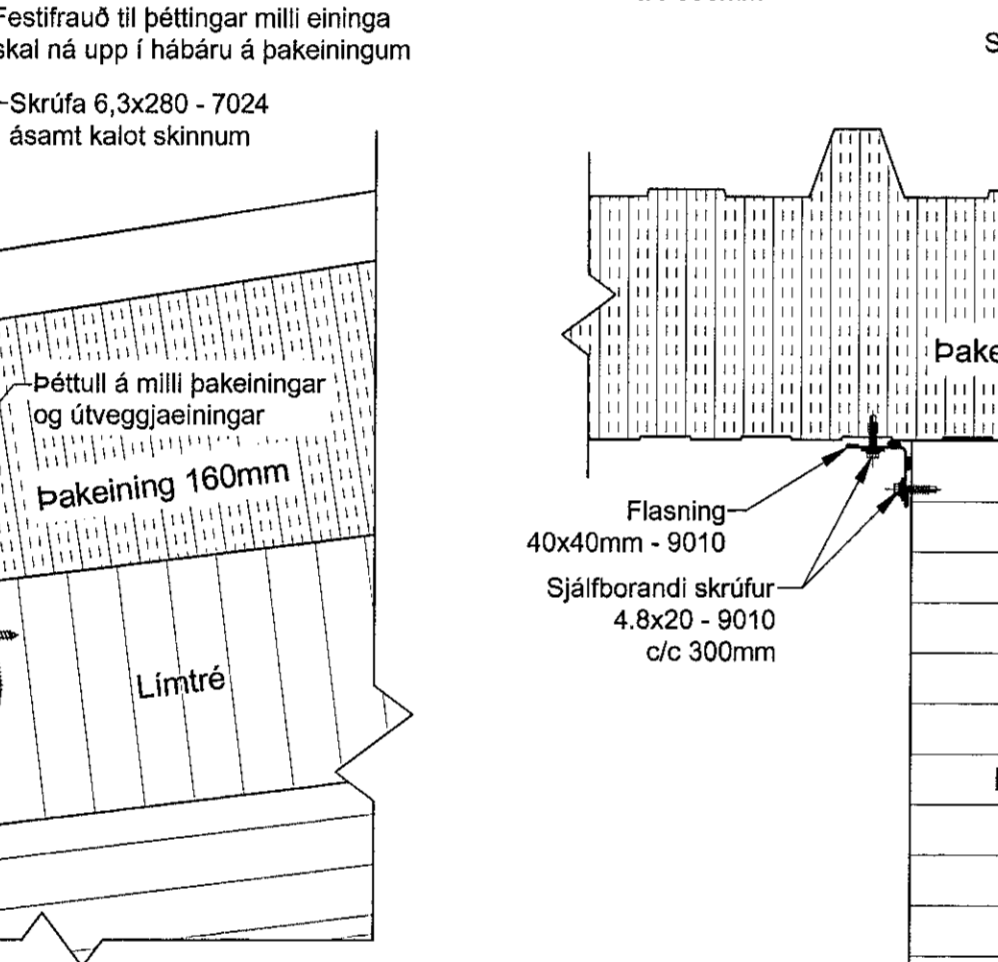
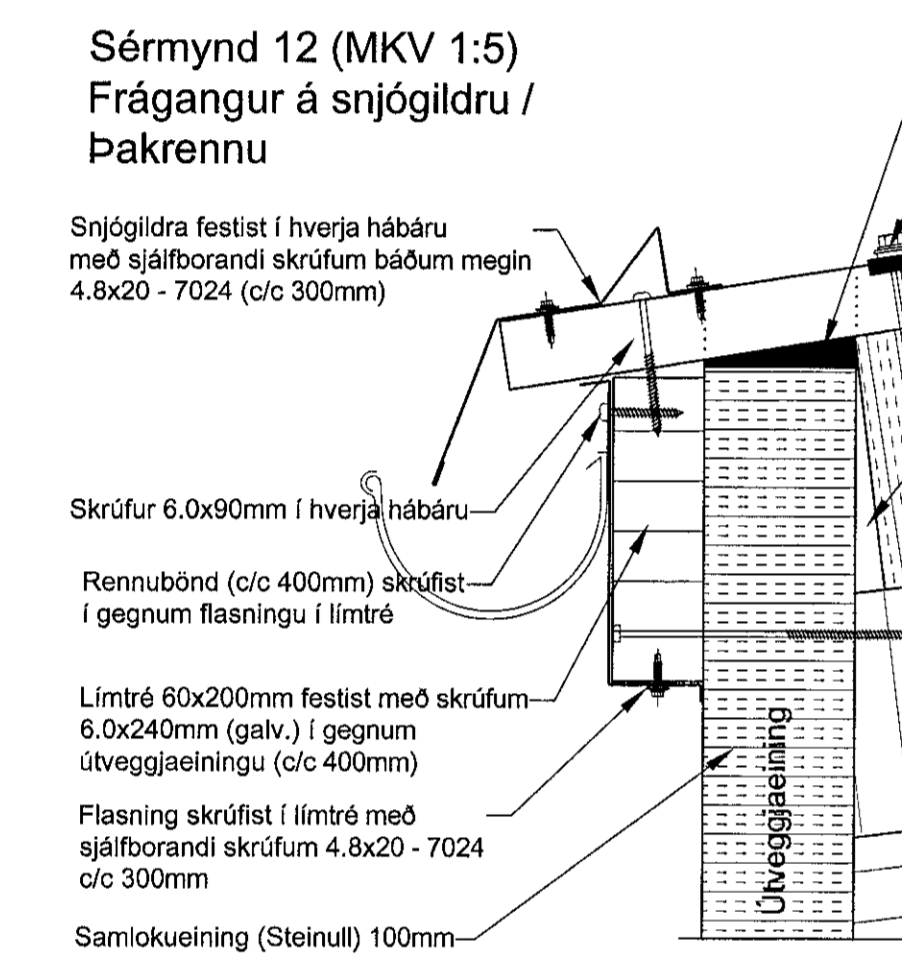
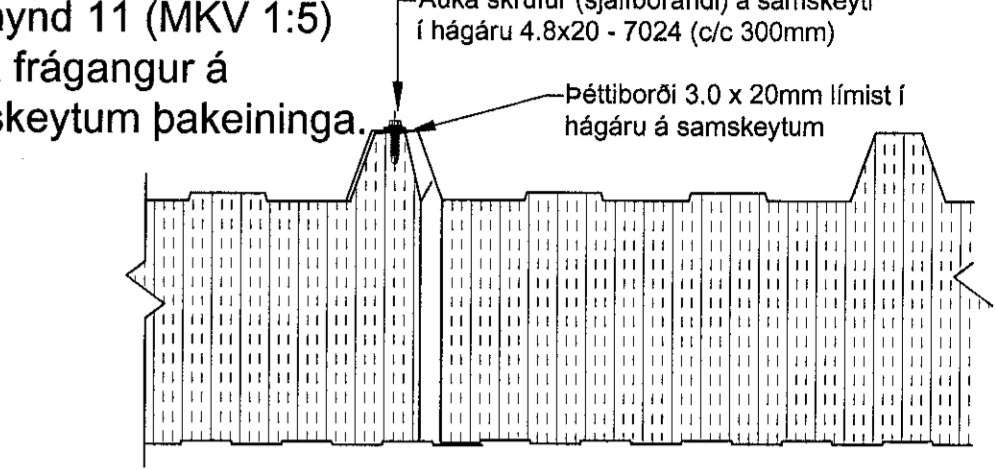
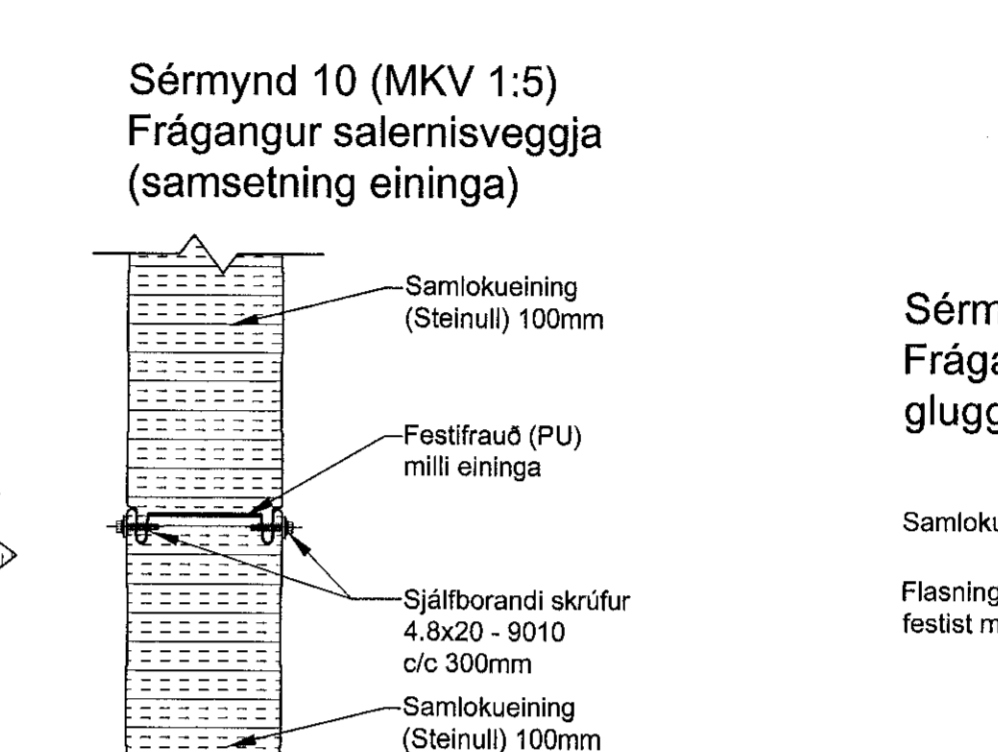
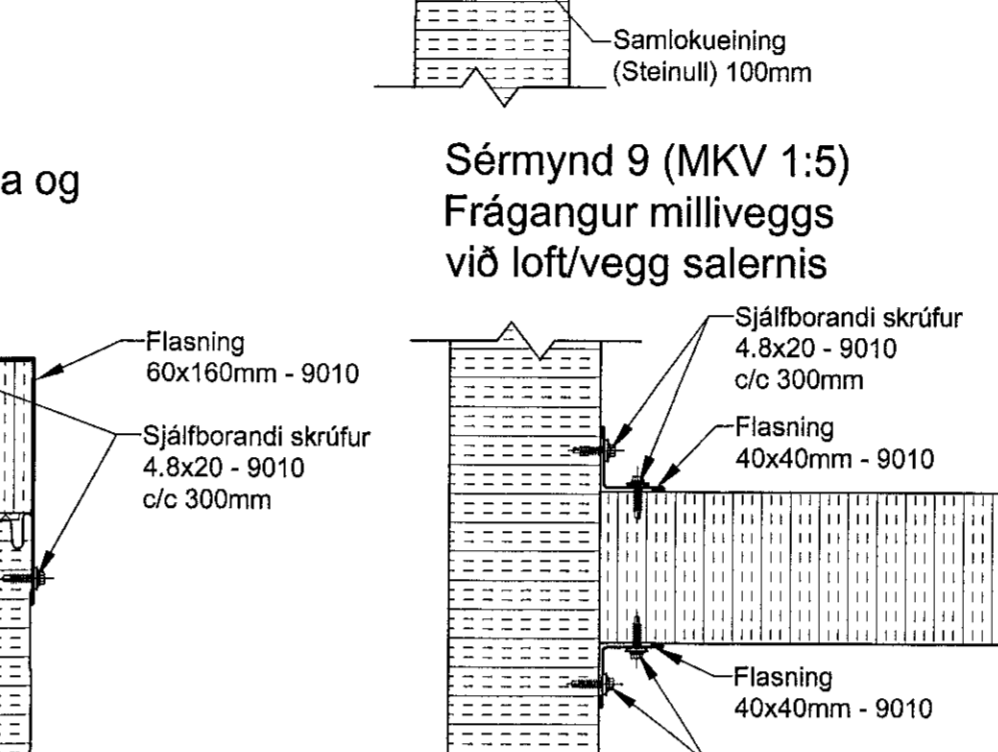
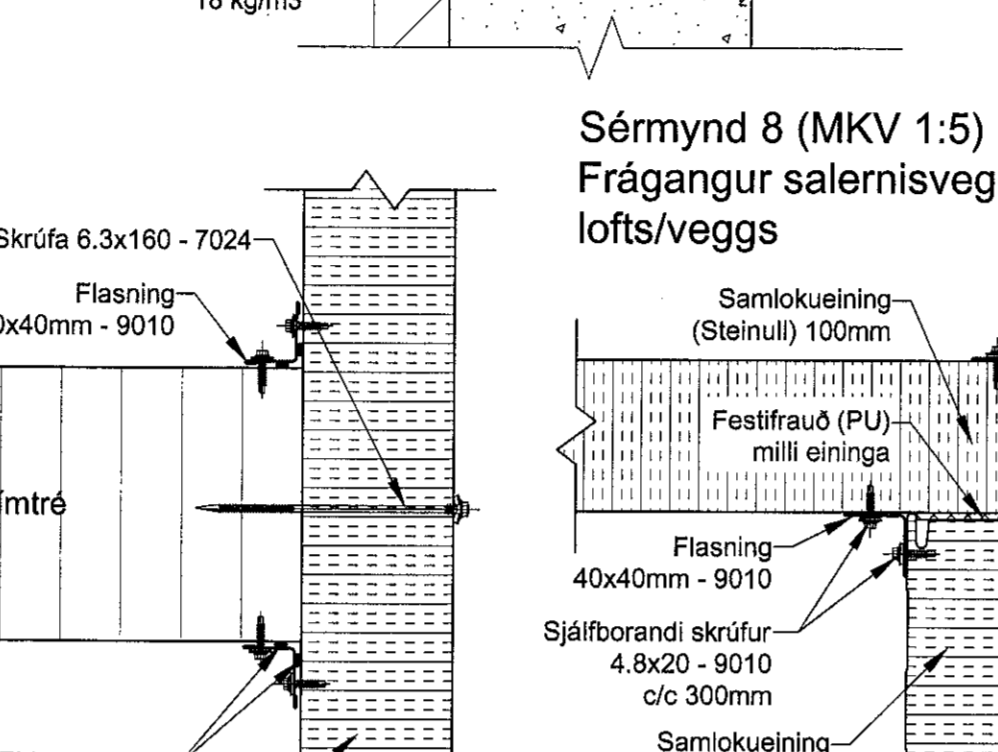
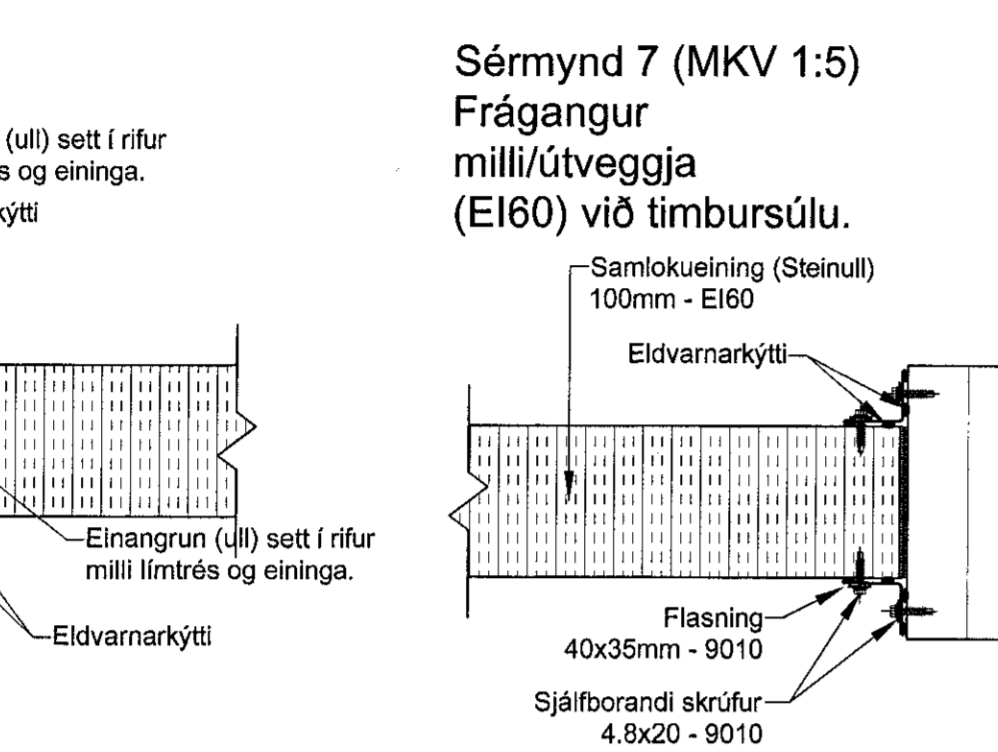
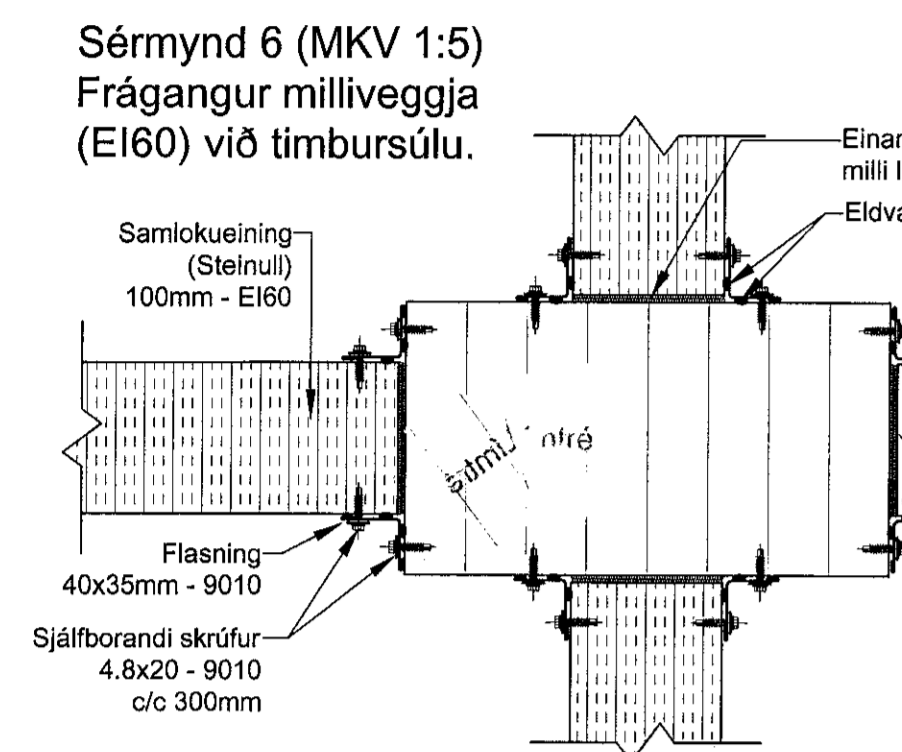
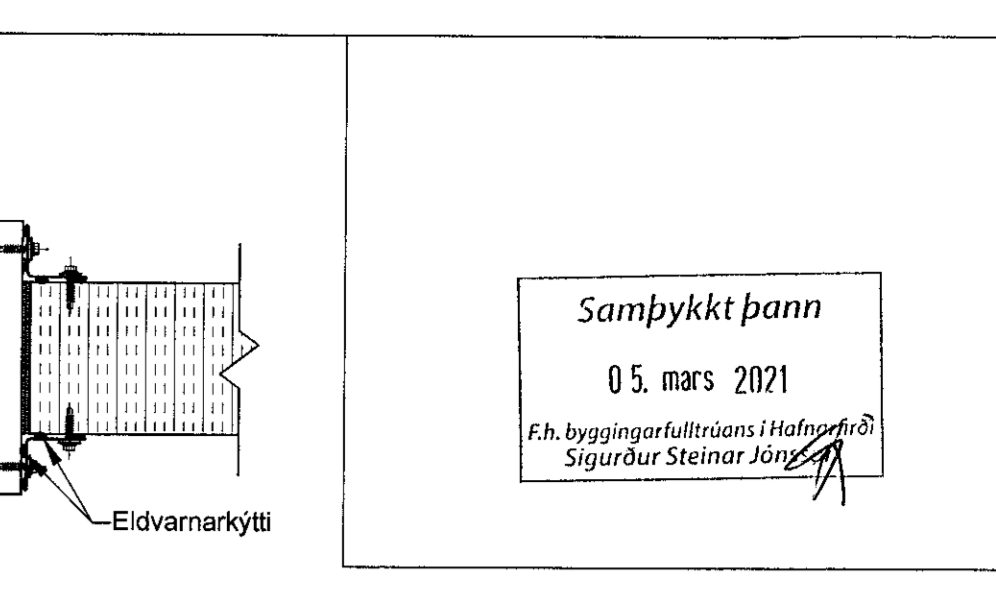
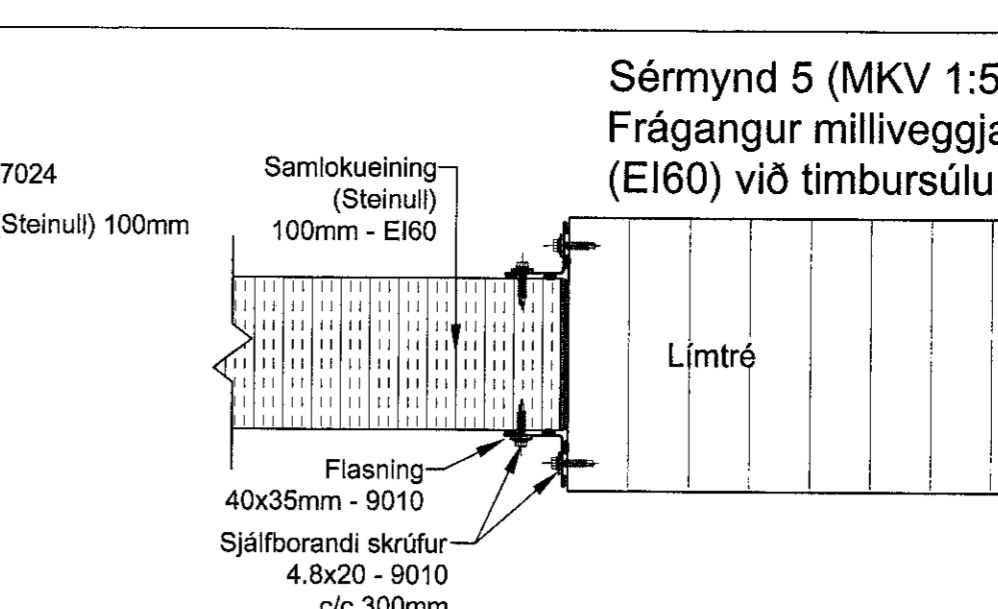
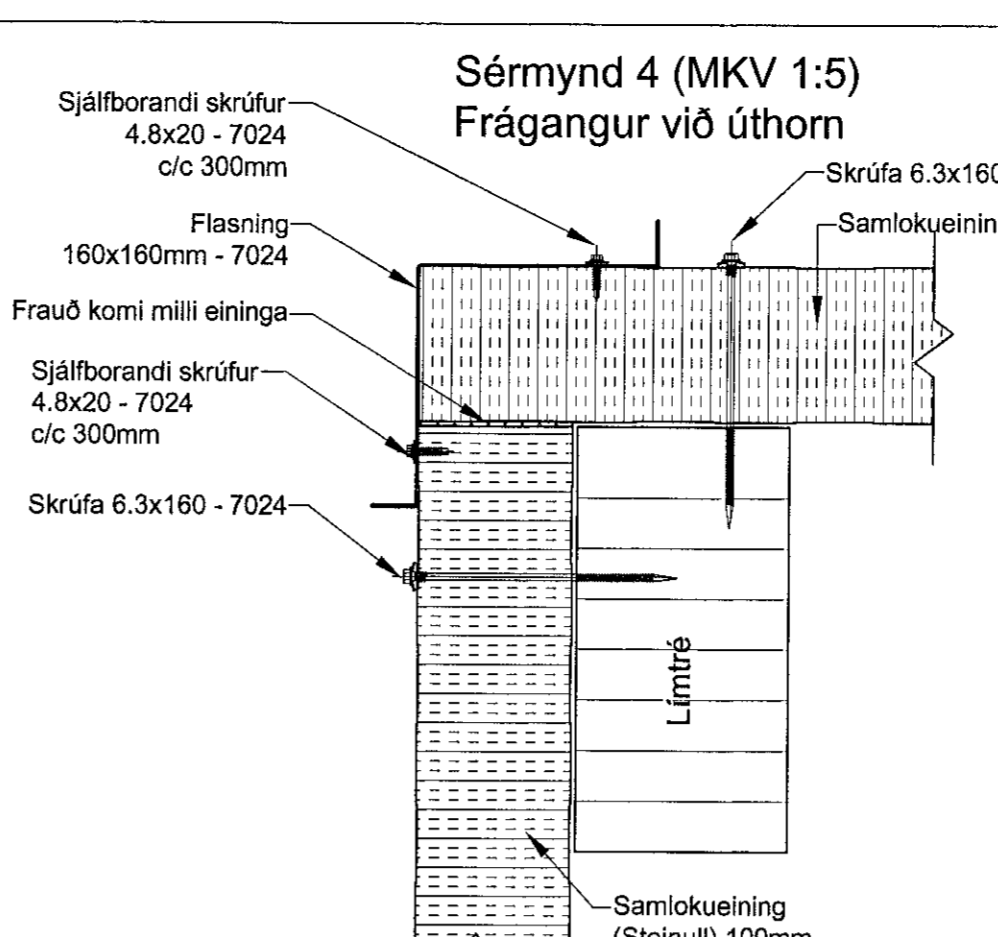
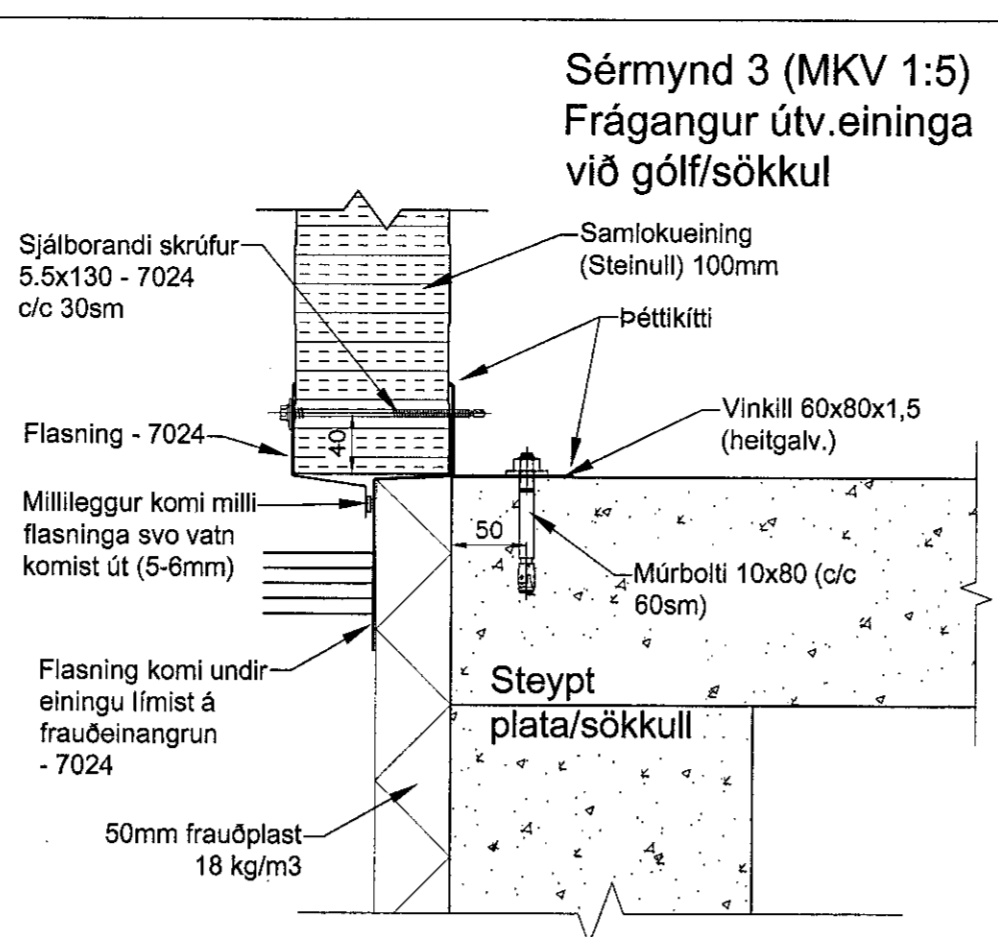
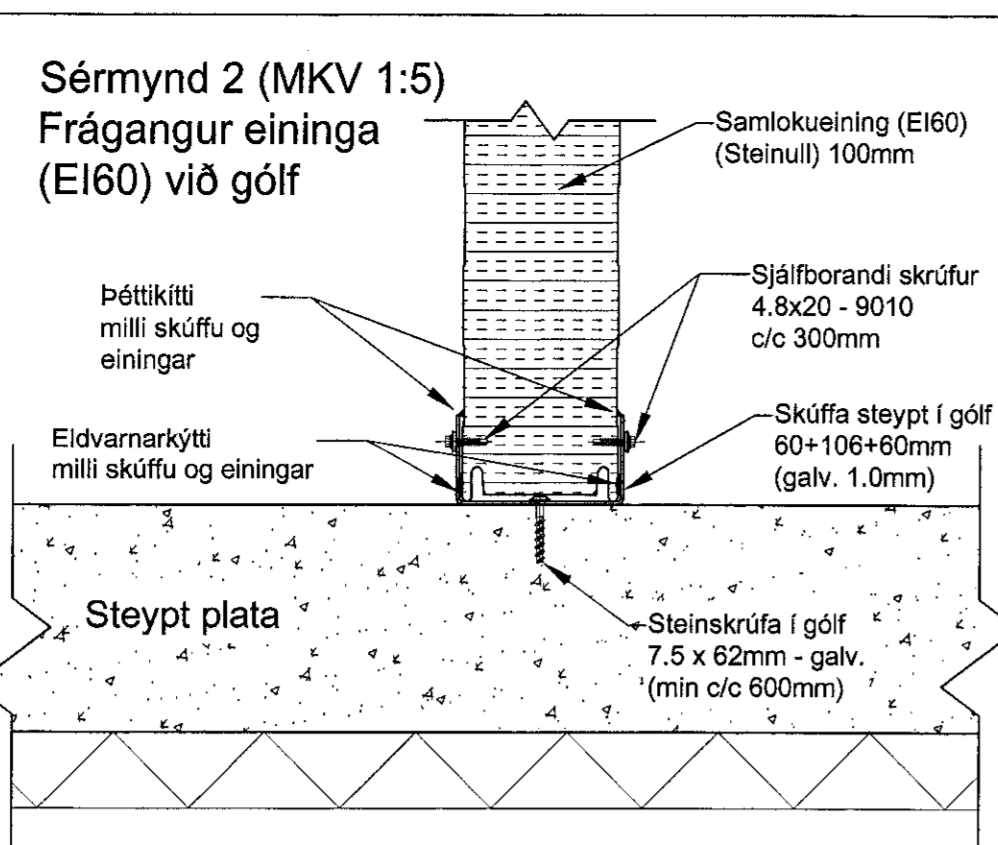
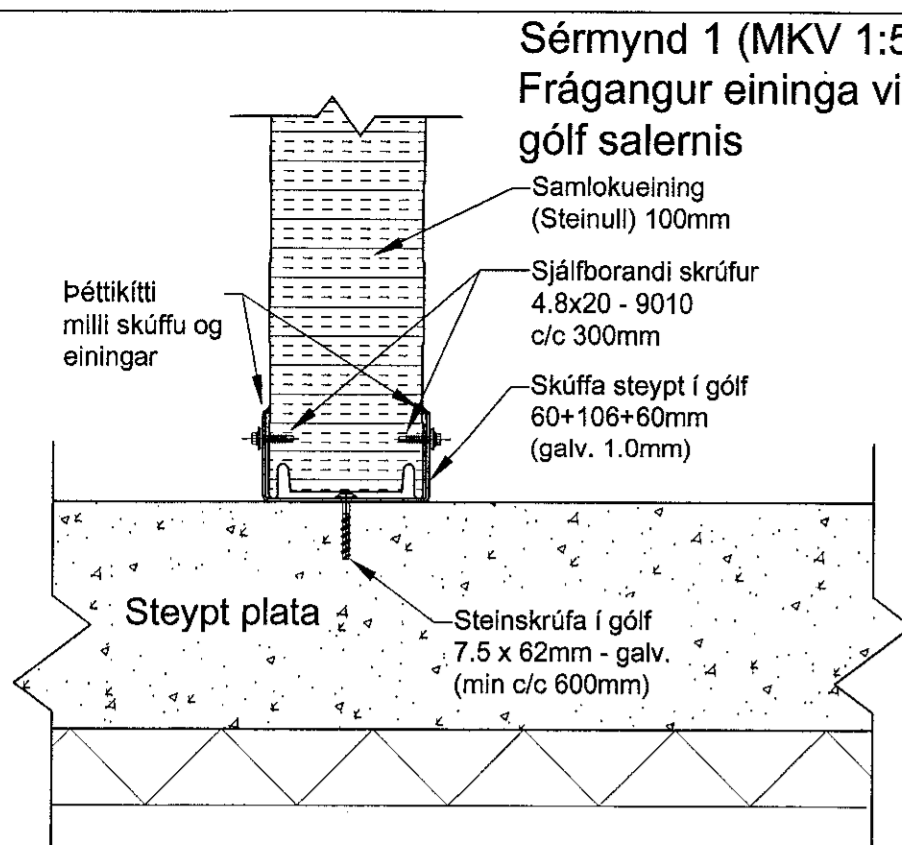

NR	DAGS	BREYTING
A		
B		
C		
Annar		

H.S.Á. TEIKNISTOFA
 TGT Hús ehf. - SUNNULÍD 12 - 603 AKUREYRI - kt. 701210-1230
 sími 464-6800 - fax 464-6801 - hura@hara.is - www.hara.is

VERKHEITI
 Gjahella 17, Hafnarfirði.
 Sérmyndir í samlokueiningar, gólf, veggja og þak.
 VERK NR 19-201
 TEIKN NR 2404-Flasnigar
 KVARNR 1:5
 DAGS 25.01.2020
 HANNAÐ HÁ TEIKNAD HÁ YFIRFARID BREYTING
 HARALDUR B. JONSSON - kt. 120149-2539
 STEINDAR H. ROYVALDSSON - kt. 145574-3769
 Anna Steindarsdóttir
 Anna Steindarsdóttir