

FRÁGANGUR VID MÆNIR - D1

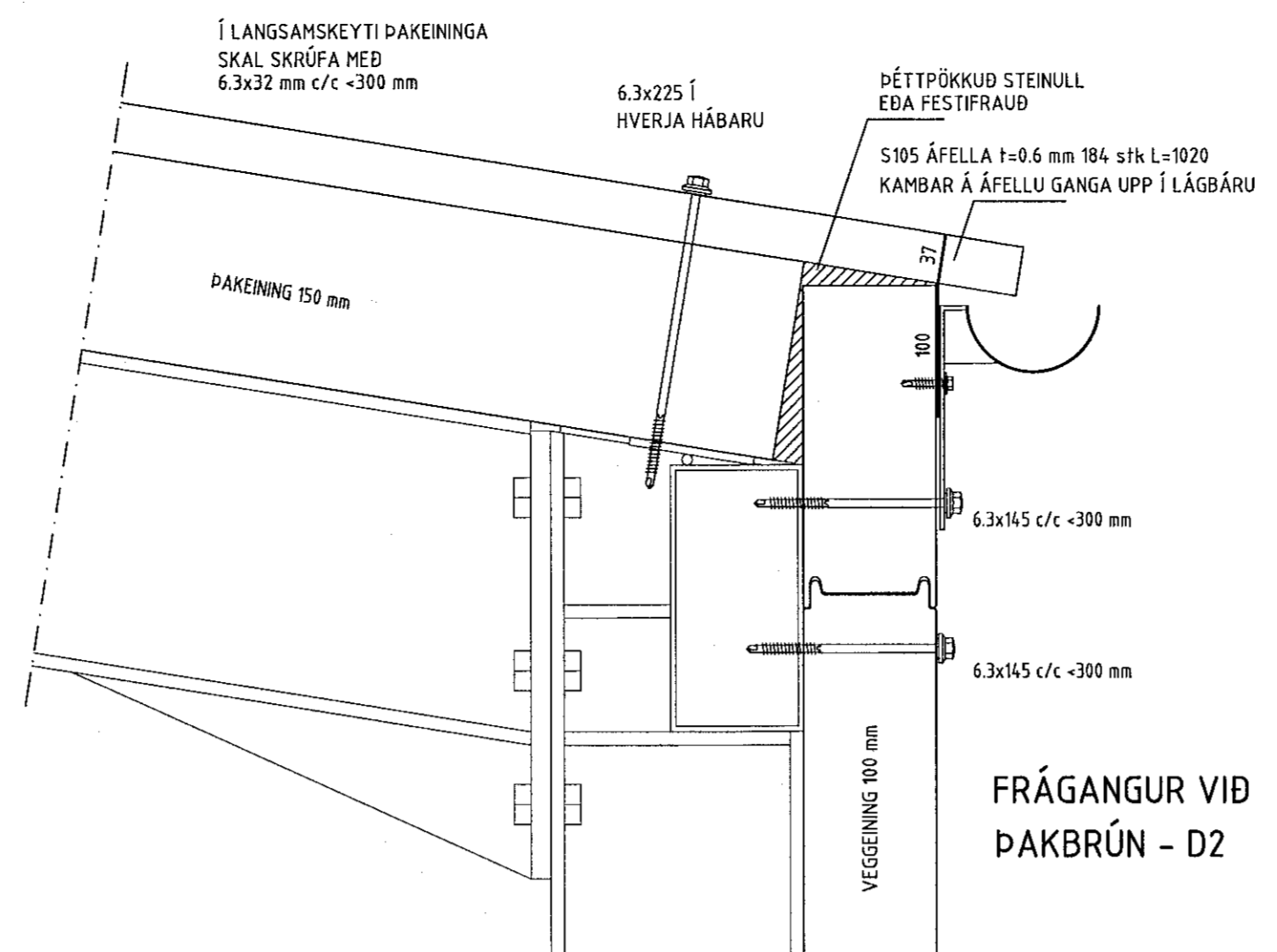

FRÁGANGUR VID ÞAKBRÚN - D2

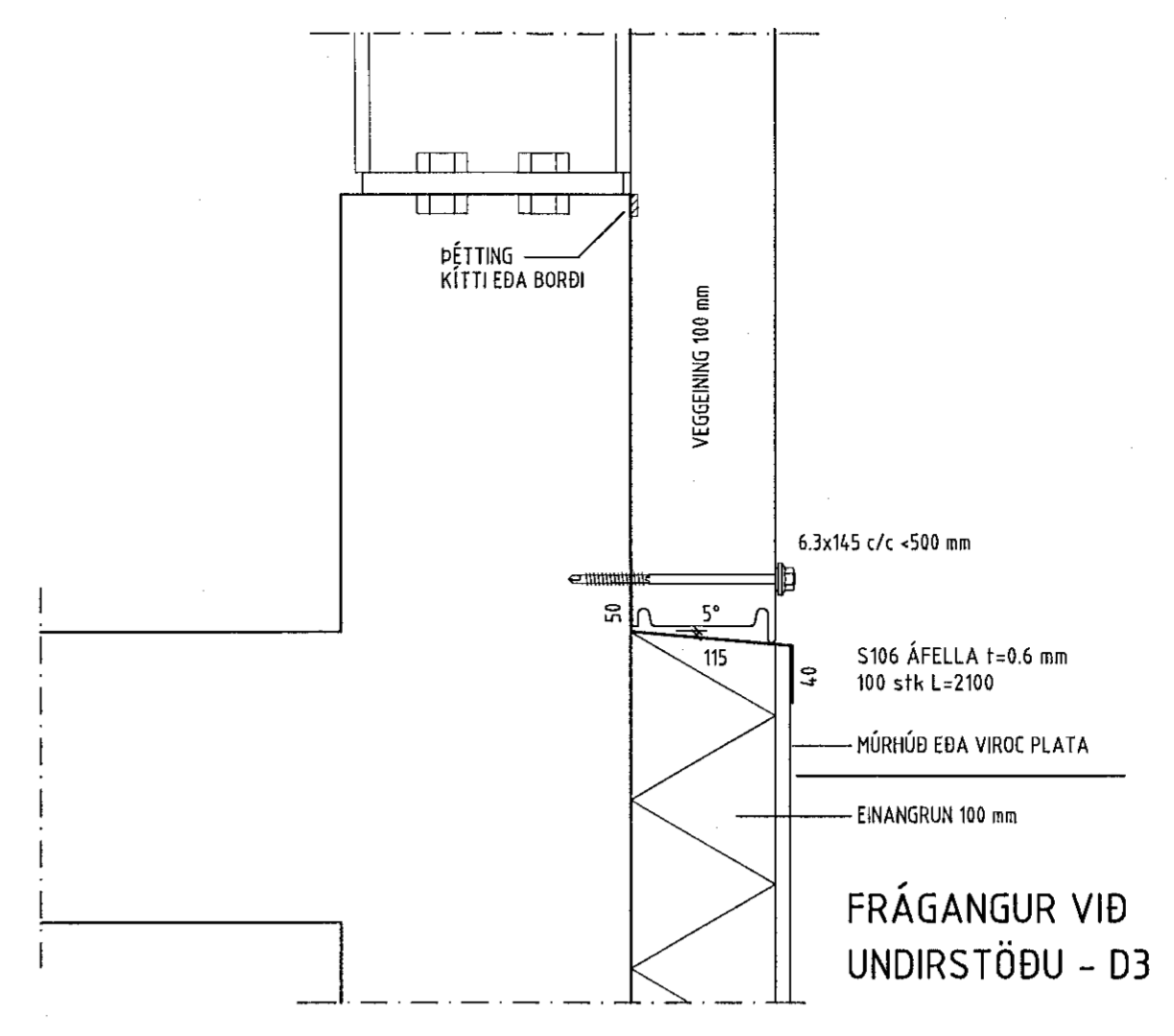

FRÁGANGUR VID UNDIRSTÖÐU - D3

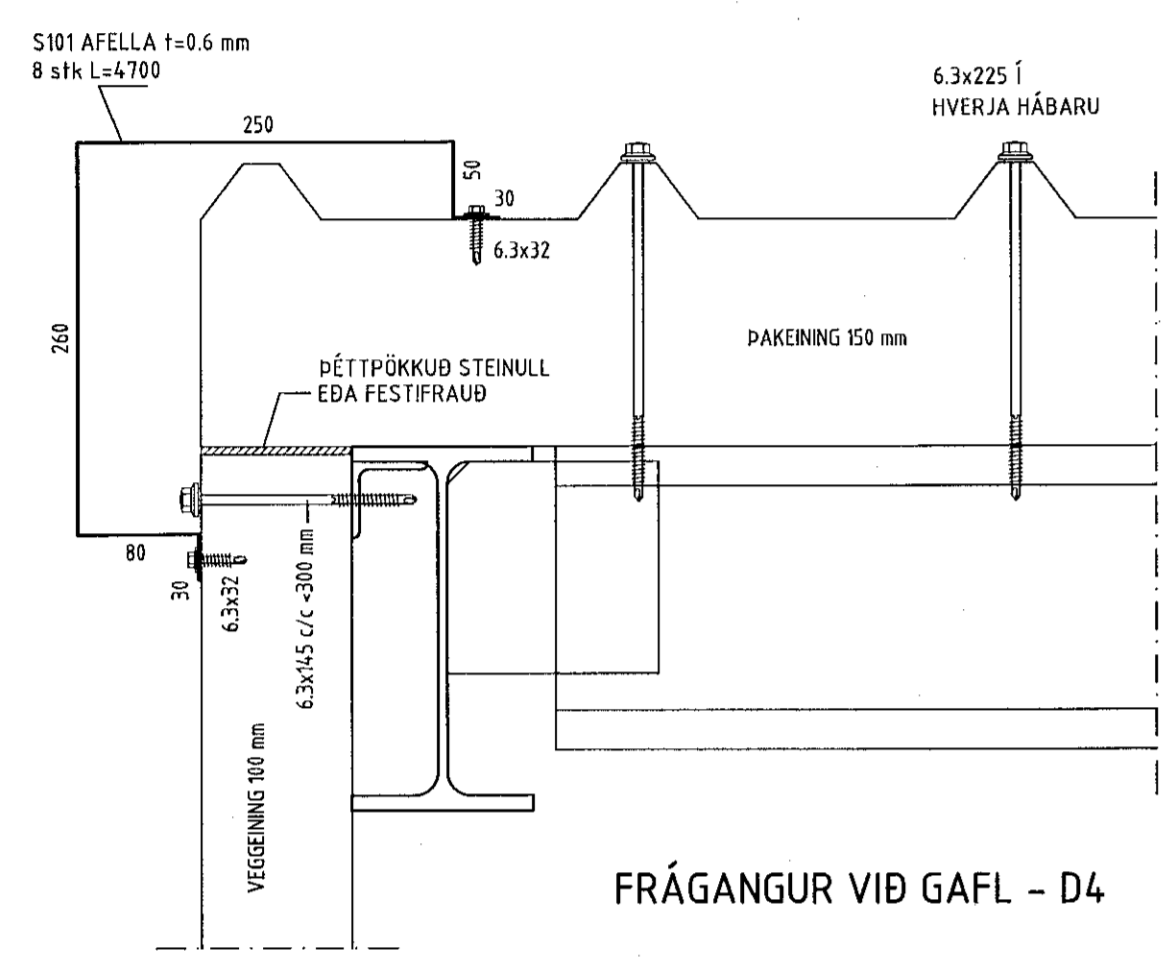

FRÁGANGUR VID GAFL - D4

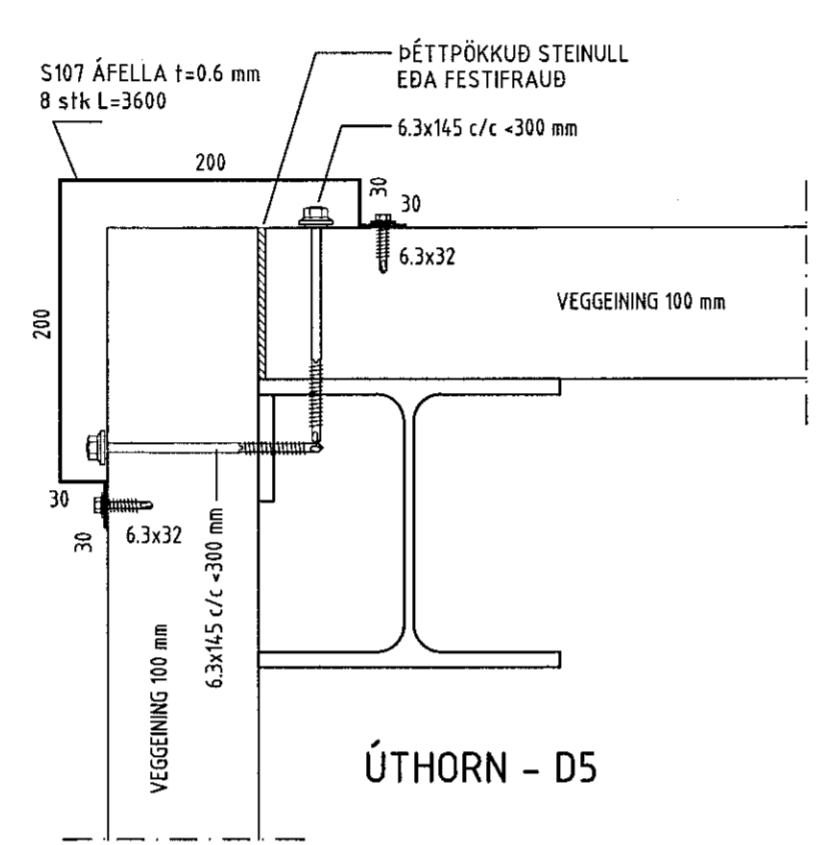

ÚTHORN - D5

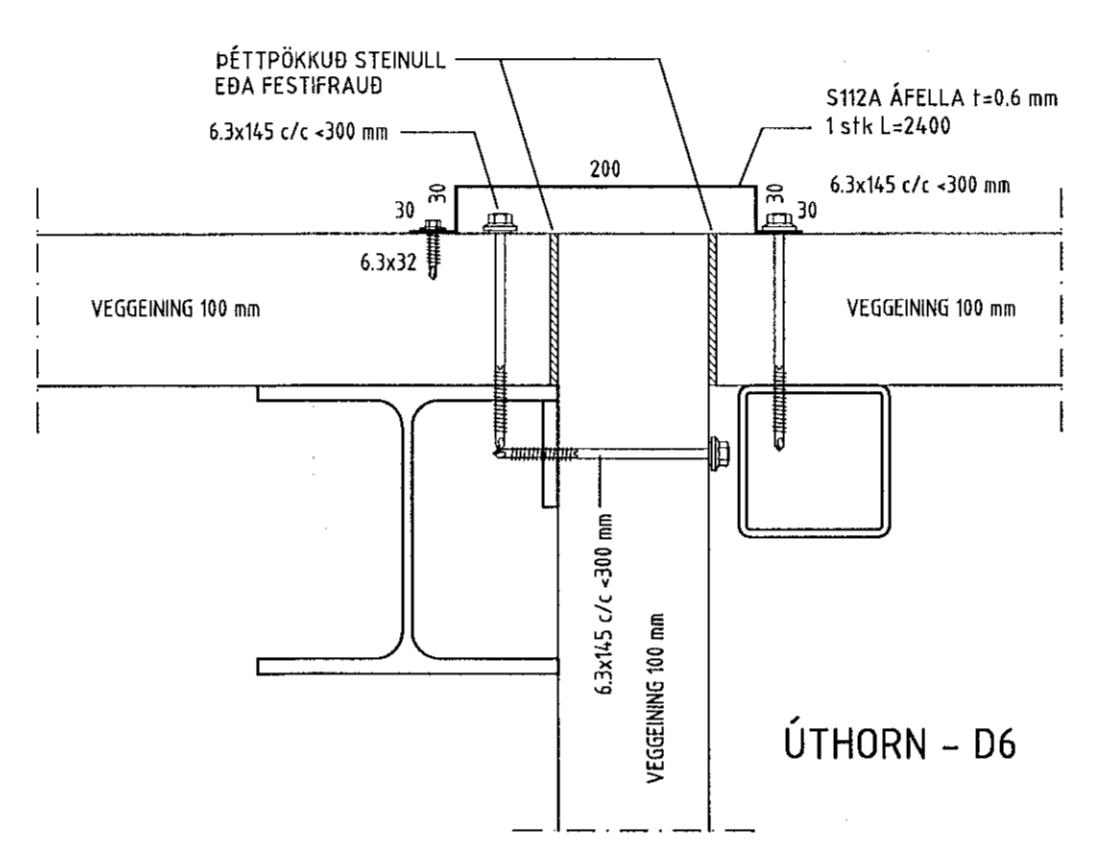

ÚTHORN - D6

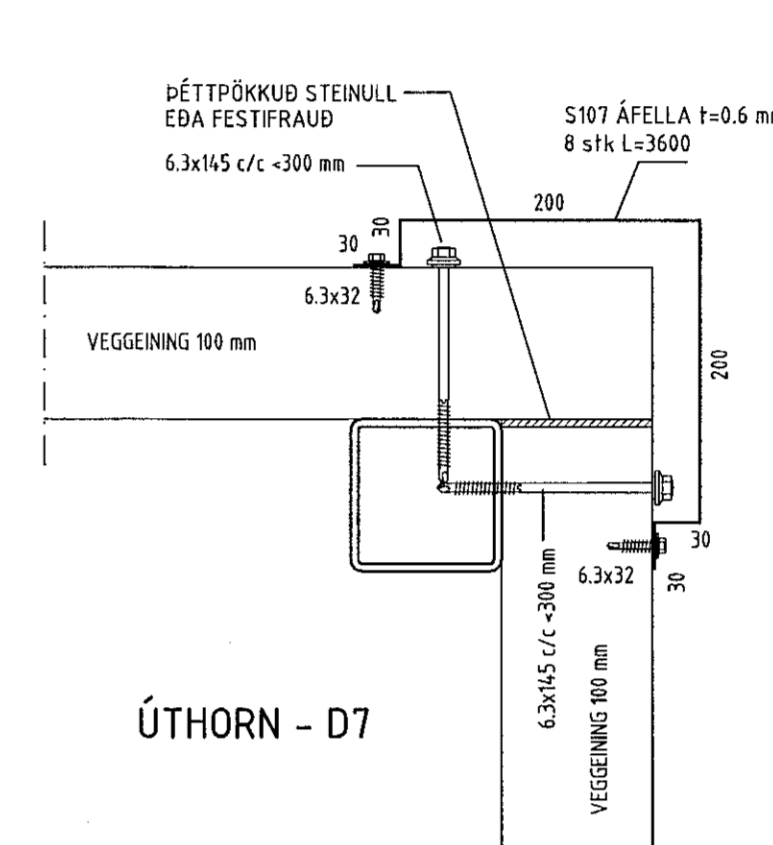

ÚTHORN - D7

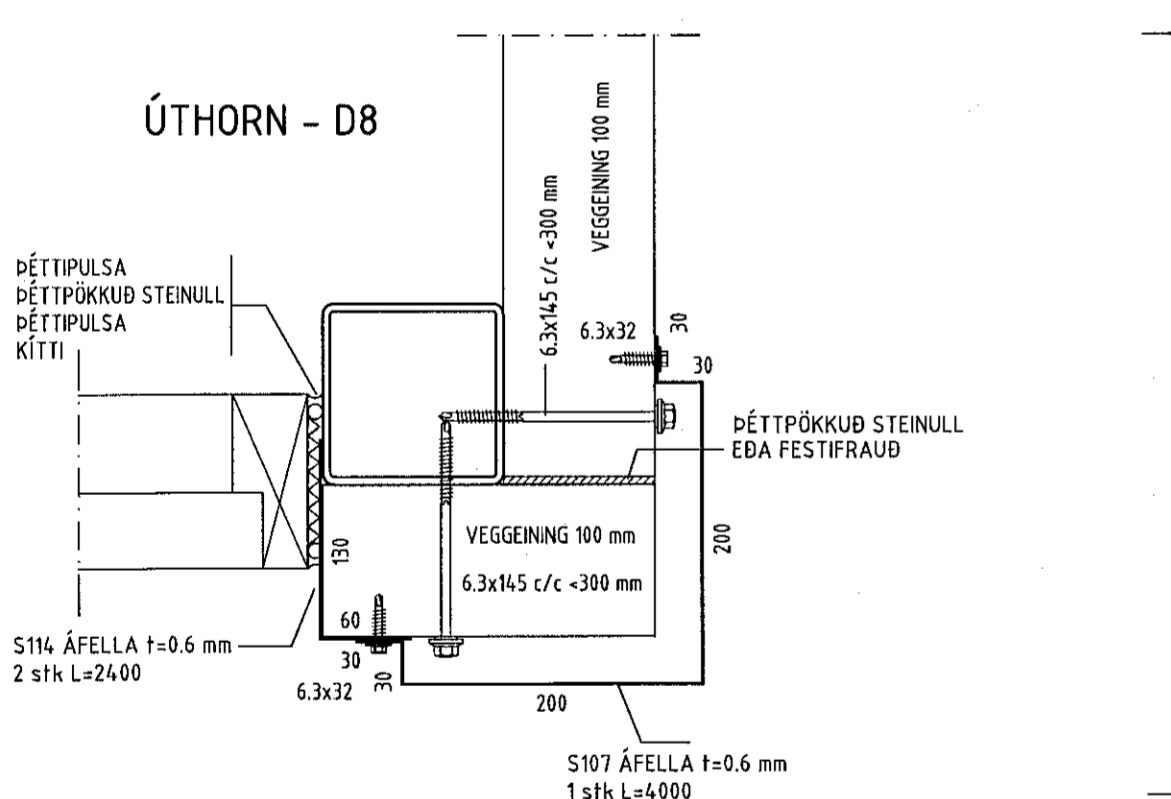

ÚTHORN - D8

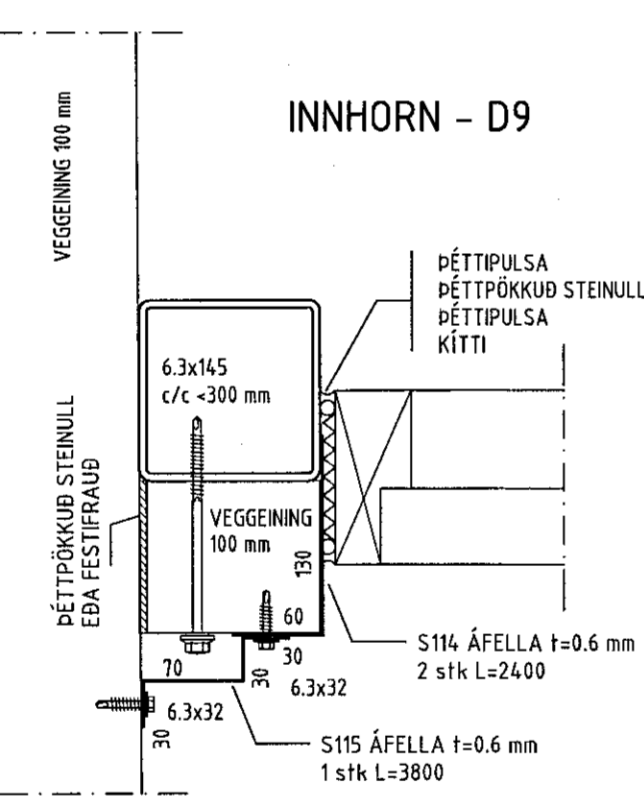

INNHORN - D9

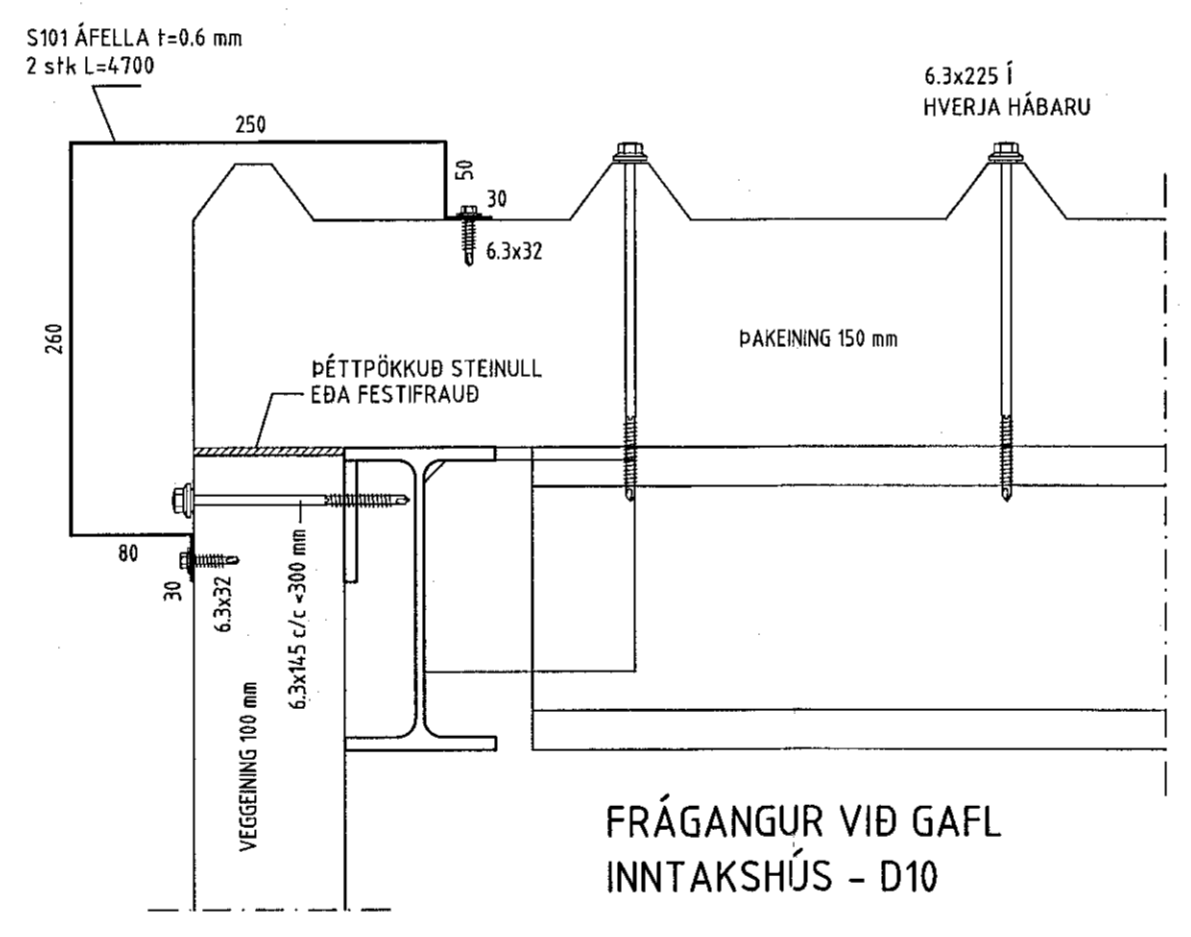

FRÁGANGUR VID GAFL INNTAKSHÚS - D10

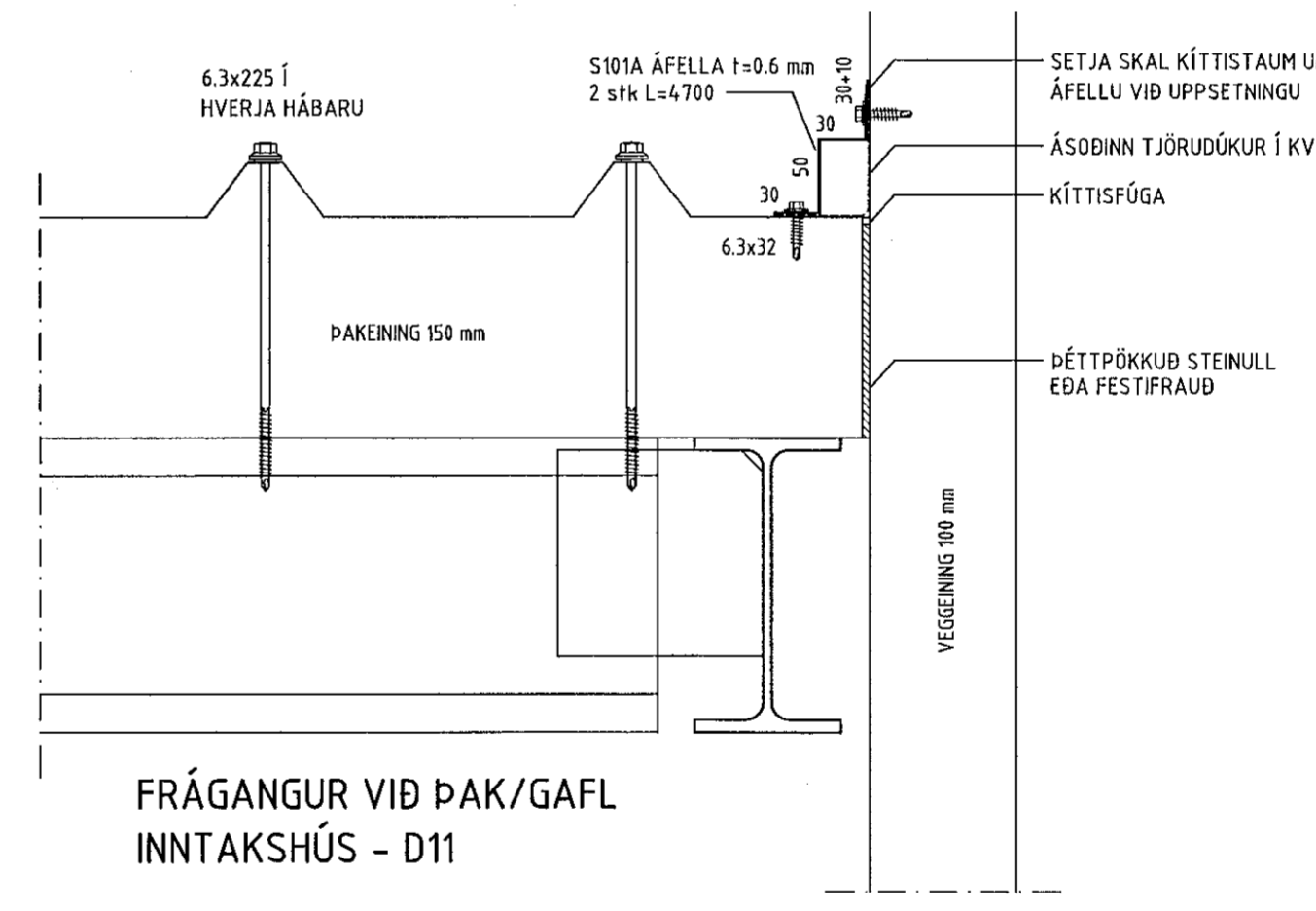

FRÁGANGUR VID ÞAK/GAFL INNTAKSHÚS - D11

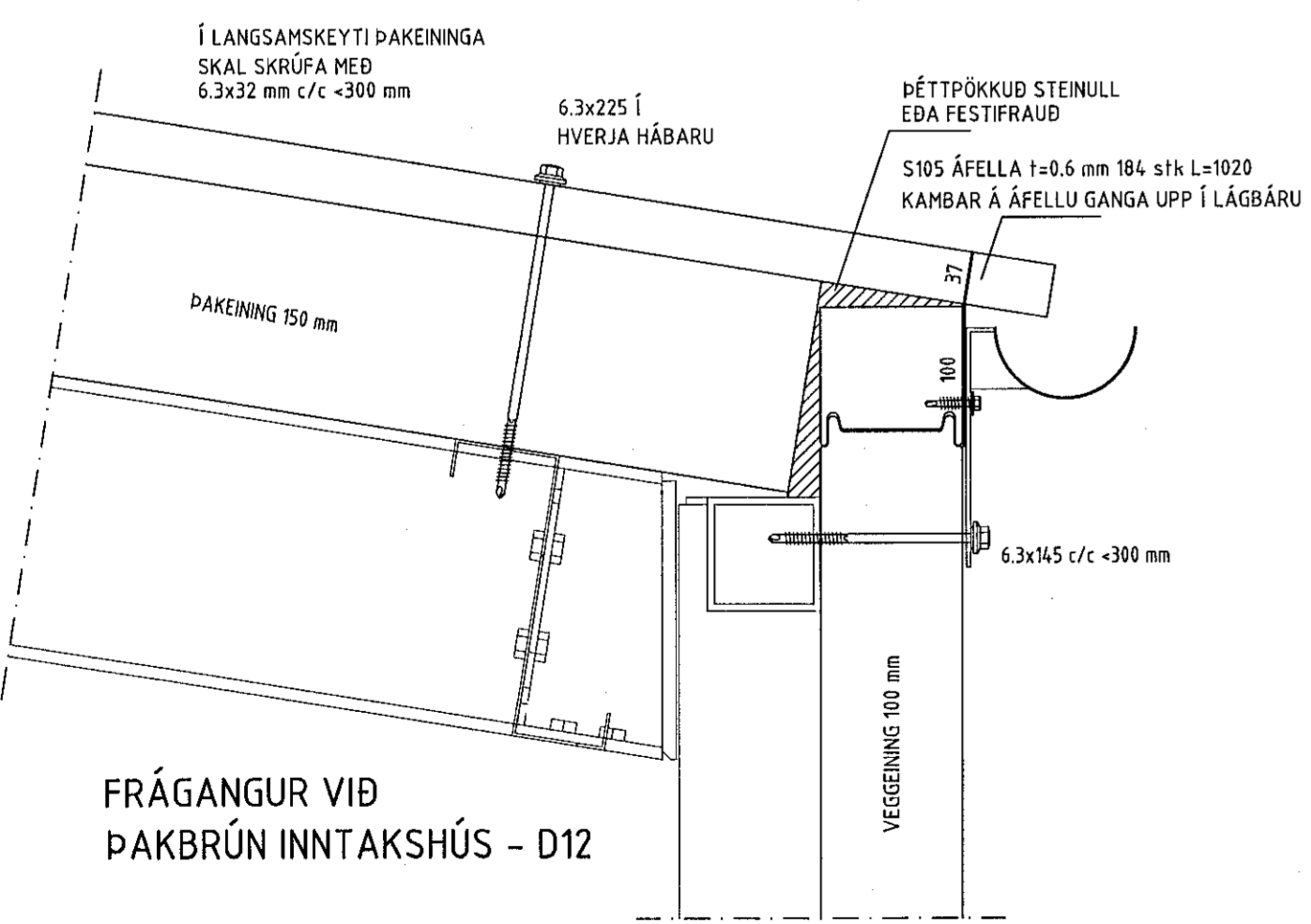

FRÁGANGUR VID ÞAKBRÚN INNTAKSHÚS - D12

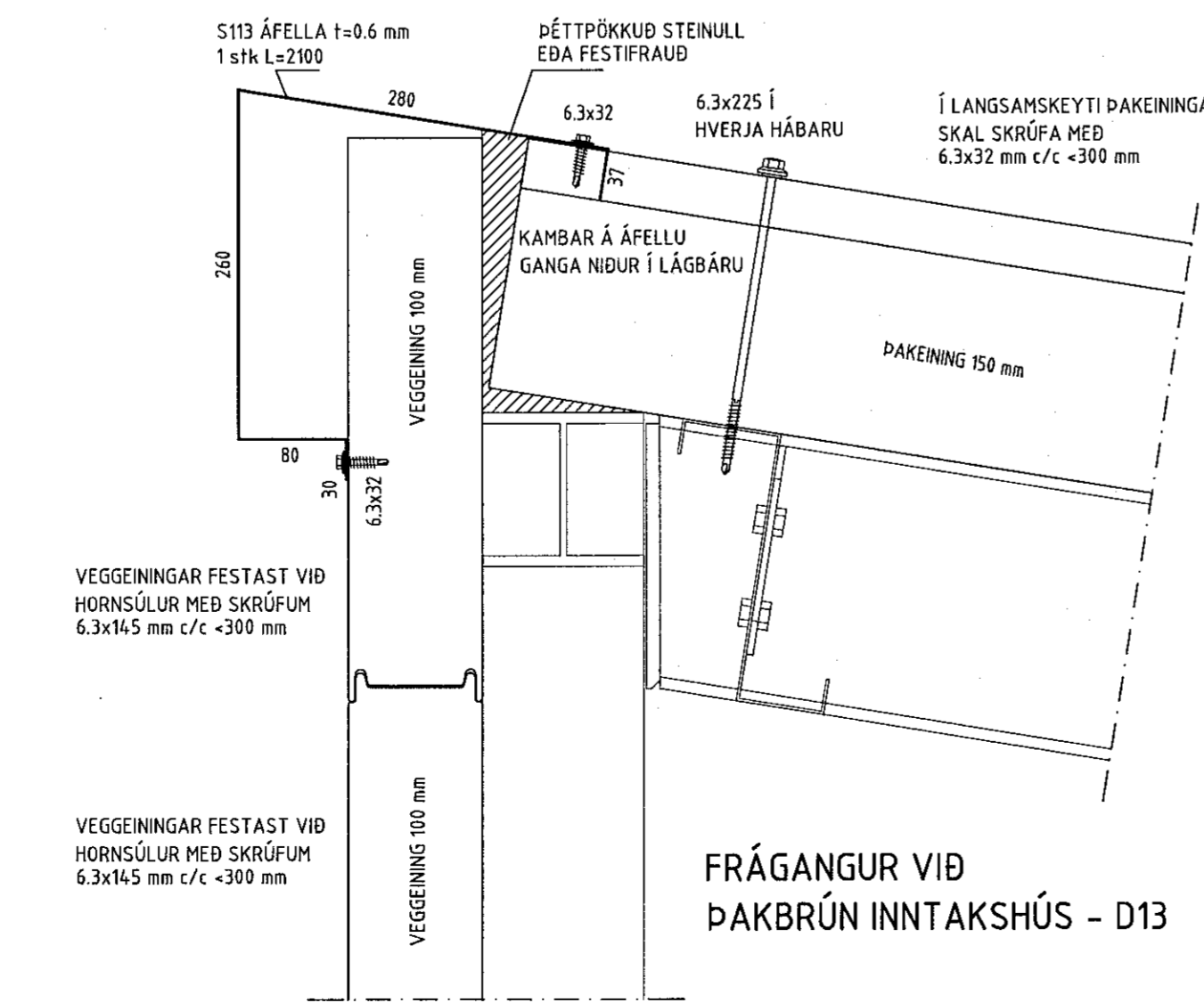

FRÁGANGUR VID ÞAKBRÚN INNTAKSHÚS - D13

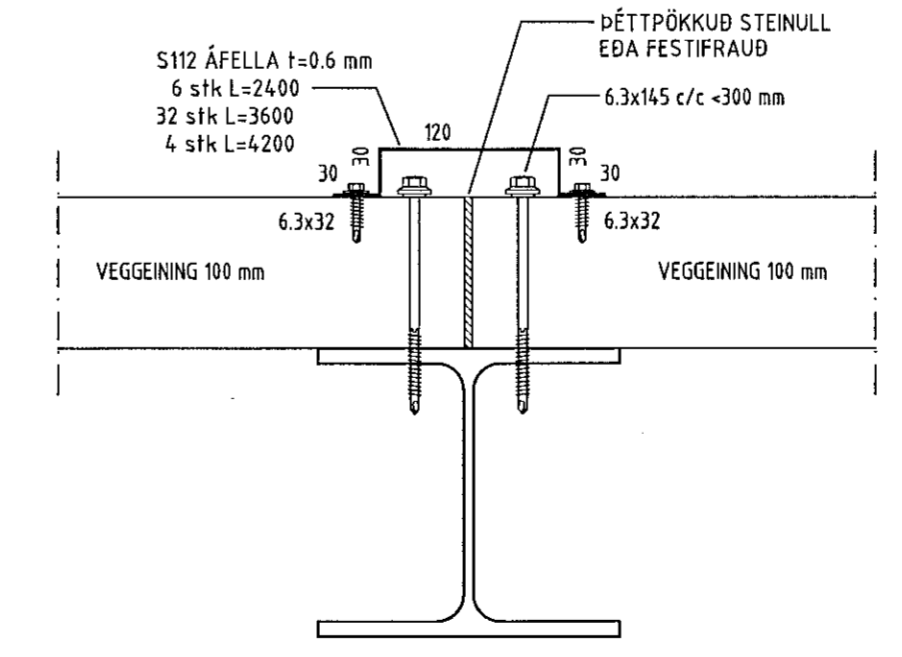

SAMSEYTI VEGGEININGA - D14

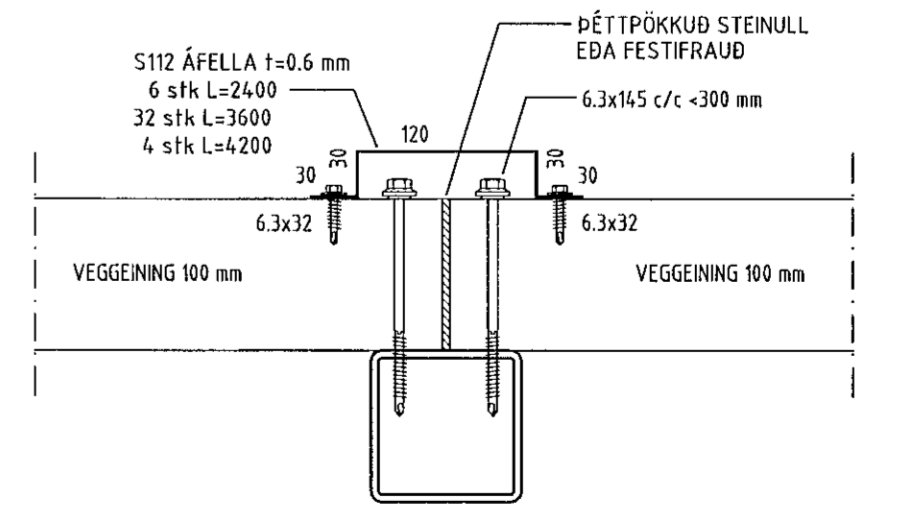

SAMSEYTI VEGGEININGA - D15

Samykkt bann
25. mars 2021
Eh. byggingarfulltrúars í Hafnarfjarðum
Sigurður Steinir Jónsson

NR.	DAGS.	BREYTING
A	19/2/21	BREYTT DELJ D3
B	03/2021	LAGFARÐ TEKNING

SKÝRINGAR

MÁLSETNINGAR ERU Í MILLIMETURUM EKKI SKAL MÆLA UPP AF TEKNINGUM

KLÆBNING ÚTVEGGJA :
STEINULLAR STÁLSAMLÖKUR, ÞYKKT 100 mm
RAL 9007. ÁFELLUR RAL 7016

KLÆBNING Á ÞAKI :
STEINULLAR STÁLSAMLÖKUR, ÞYKKT 150 mm
RAL 9007. ÁFELLUR RAL 7016

KLÆBNING Á MILLIVEGGJUM :
STEINULLAR STÁLSAMLÖKUR, ÞYKKT 100 mm
RAL 9010. ÁFELLUR RAL 9010

EFNSLISTI VEGG- OG ÞAKENINGAR SJÁ TEKNINGU D 005

DEILIMYNDIR OG ÁFELLUR SJÁ TEKNINGAR D006 OG D007 (D15) MERRI : ÁFELLA Á VEGG - EKKI SAMSEYTI

Sigurður Steinir Jónsson
ADALFRUNDIR
SIGURÐUR HALLGRÍMSSON 170753-3139

19/3/21
S/EMUNDUR EIRIKSSON 261249-2949

DOFRAHELLA 2A
220 HAFNARFJÖRÐUR

KLÖPP
KLÖPP ARKITEKTAR-VERKFRÆÐINGAR EHF
NJARDARHOLT 3 270 MOSFELLSSÍÐER
SÍMI 577 2277, 699 7747 - klopp@sinnet.is

HEITI TEKN.	DEILIMYNDIR
MÆLIKVARDI	15
DAGS.	JAN 2021
TEKNING	D 006
VERK	V 20-507
BREYTING	B
YFIRFARID	S.E.