

BLÓMVELLIR 20. HAFNARFIRÐI.

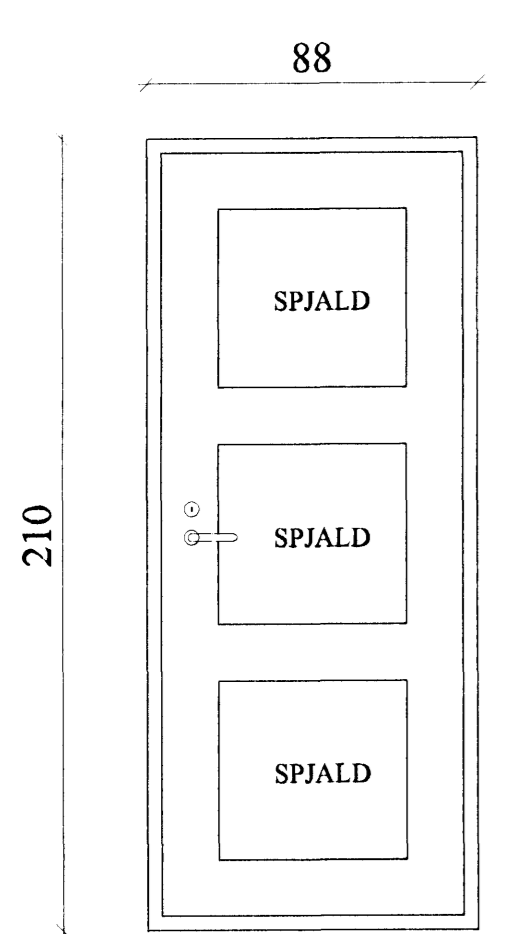

HURÐASPJALD 80
MÁL TAKIST Á STAÐNUM
G 1. 1.stk.
bílskúr

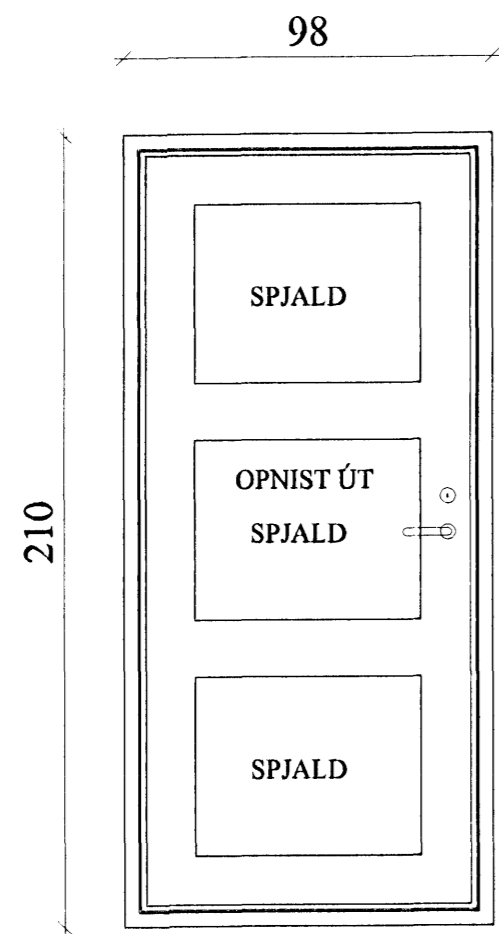

HURÐASPJALD 900
MÁL TAKIST Á STAÐNUM
G 2. 1.stk.
bílskúr

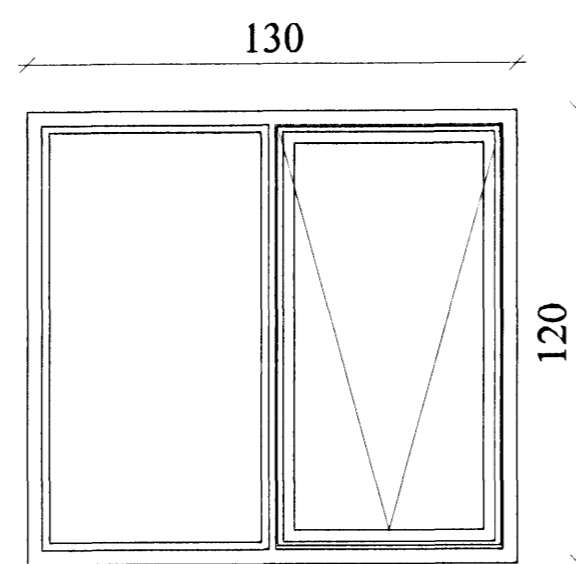

G 3. 4.stk.

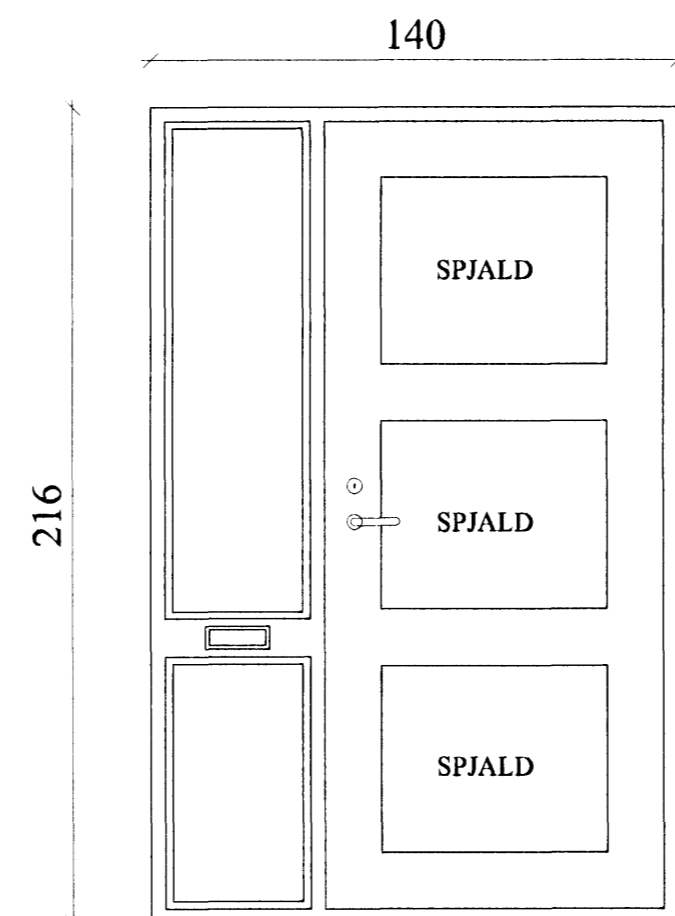

HURÐASPJALD 900
MÁL TAKIST Á STAÐNUM
G 4. 1.stk.
útihurð

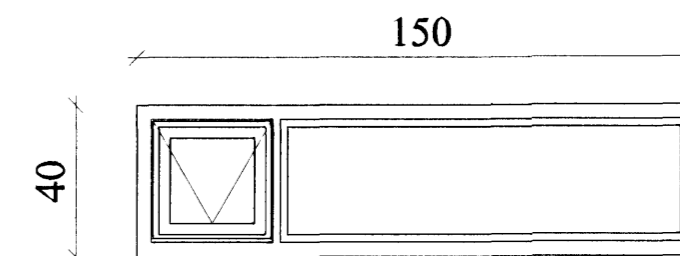

G 5. 3.stk.

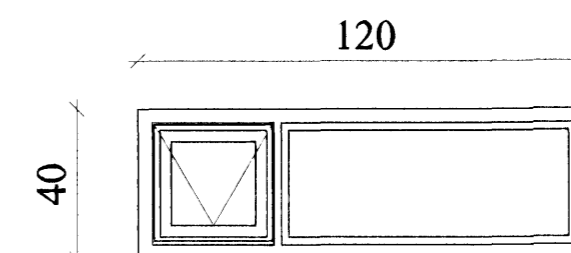

G 6. 1.stk.

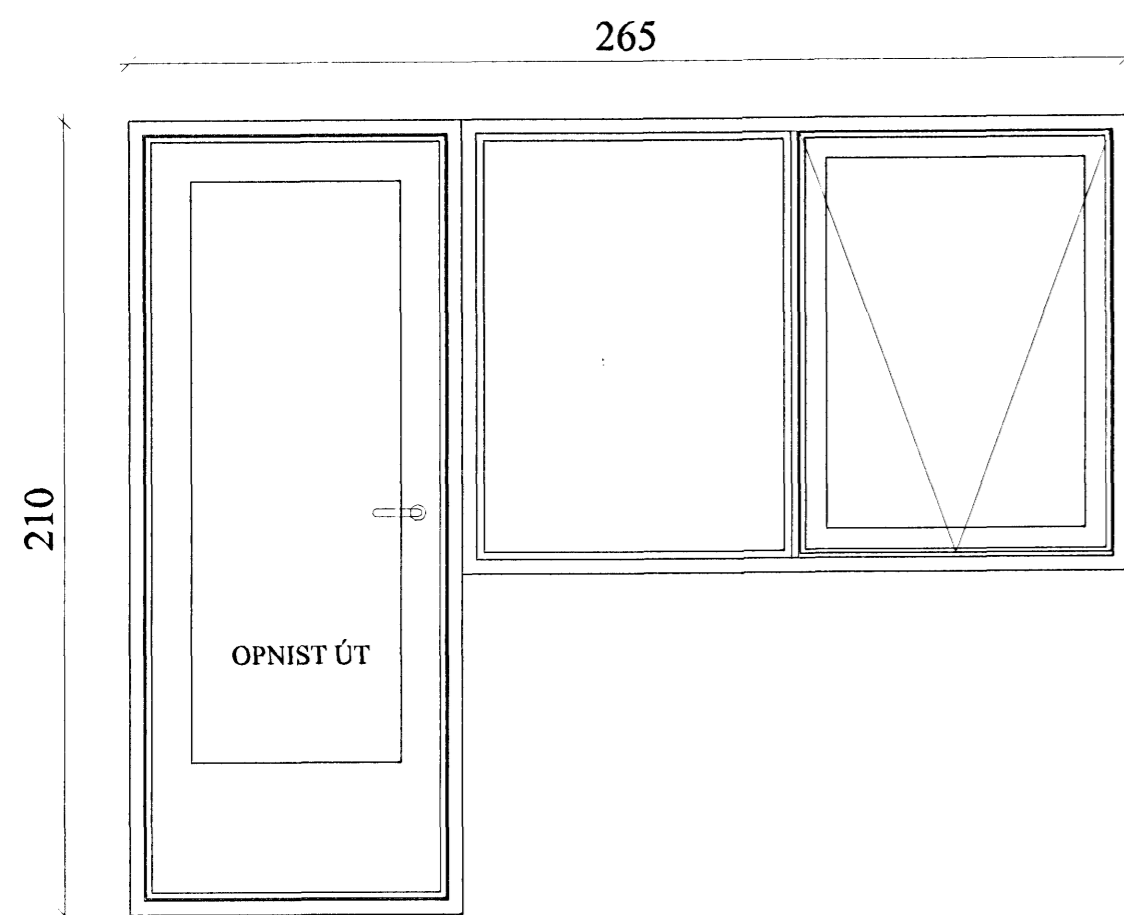

G 7. 1.stk.

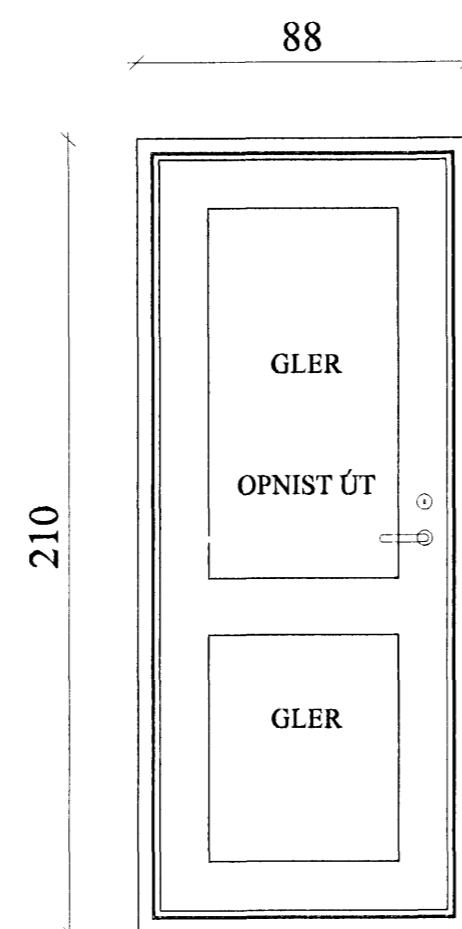

HURÐASPJALD 80
MÁL TAKIST Á STAÐNUM
G 8. 1.stk.
svalahurð

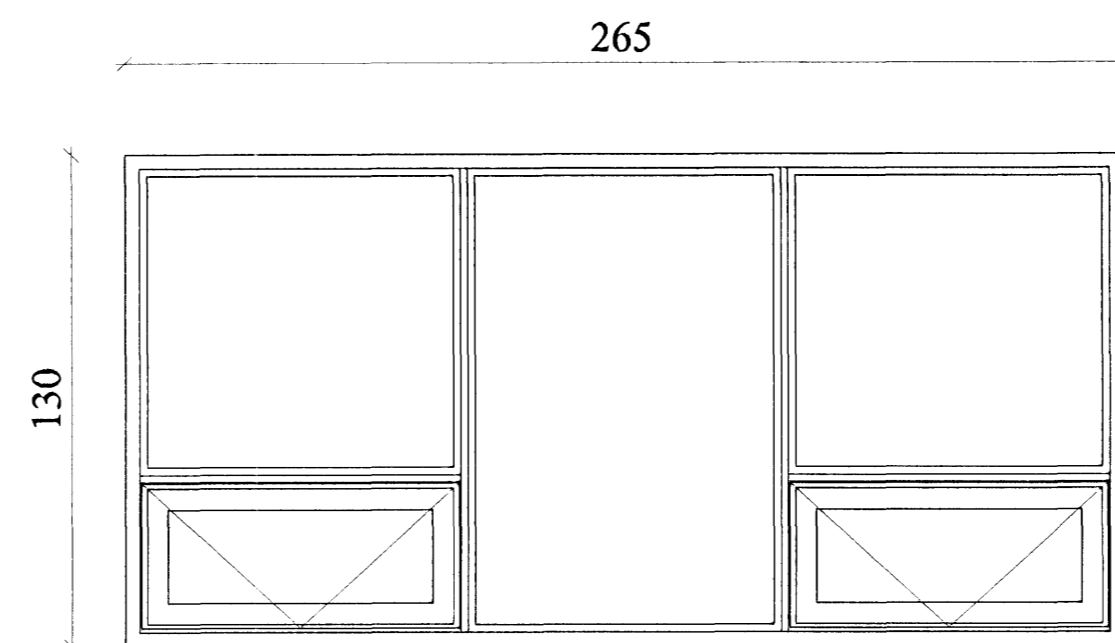

G 9. 1.stk.

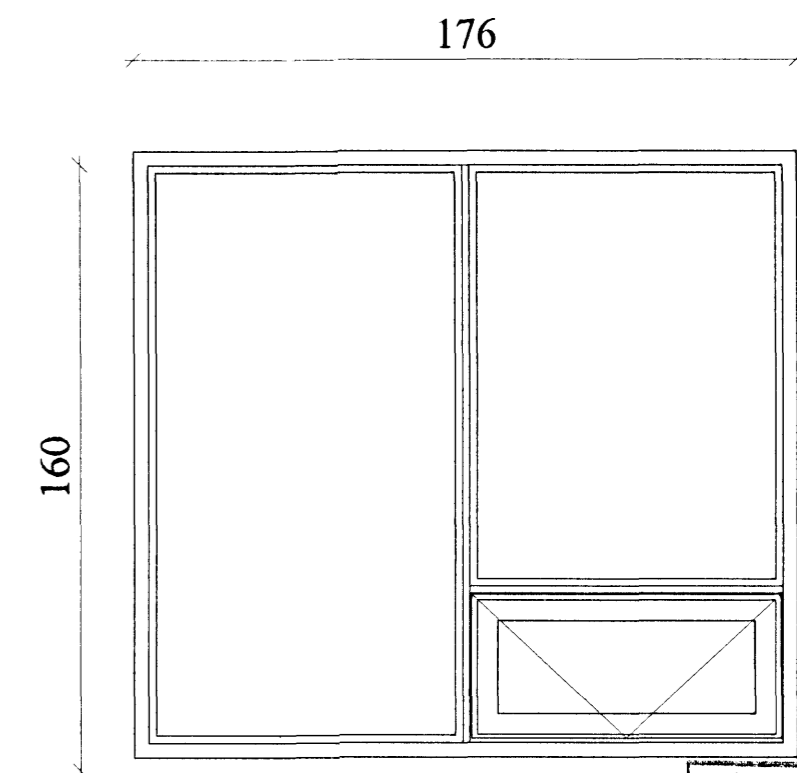

G 10. 1.stk.

Byggingatulltrúi Hafnarfjarðar
Afgreitt þann
30 JULI 2003
VG

Teiknistofan Húsagerð og Skipulag Birkiás 19. Garðabæ. Sími 8978564.
Gunnar Sigtryggur Einarsson Byggingafræðingur. BFÍ. kt. 020550.2369. e-m. gse@vortex.is

SKÝRINGAR:
HURÐIR OG GLUGGAR ERU SÉÐ UTAN FRÁ.
GLUGGAR SKULU VERA ÚR VALINNI FURU EÐA BETRA EFNI.
OPNANLEG FÖG SKULU VERA ÚR OREGON PINE EÐA BETRA EFNI.
HURÐIR SKULU VERA ÚR OREGON PINE EÐA BETRA EFNI.
GLUGGAKARMAR SKULU SMÍÐAST ÚR 2 1/2"x5".

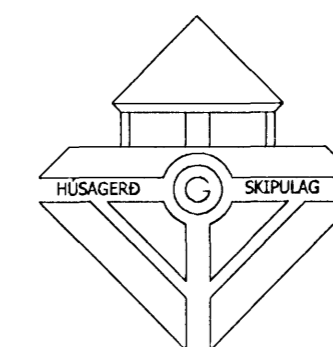

Verknúmer: 108.

Breytt:

Dags: 20. mars 2003.

Efni: Blómvellir 20. Hafnarfirði.

Heiti: Gluggar 1.

Mkv: 1:20

Hannað: *[Signature]*

07