

V1

F = 15.81 m<sup>2</sup>  
 P = 4350 kg  
 R = 1.74 m<sup>3</sup>

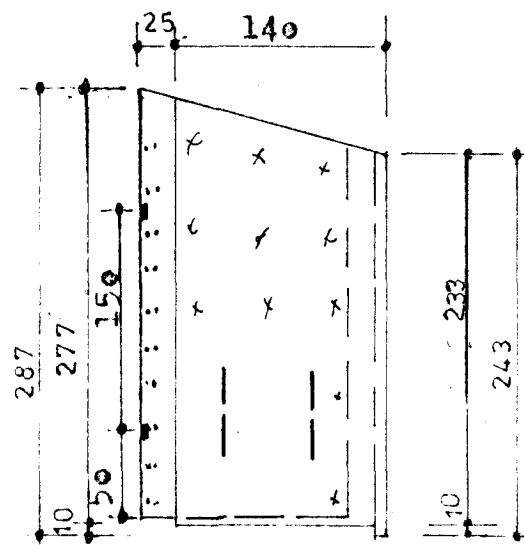
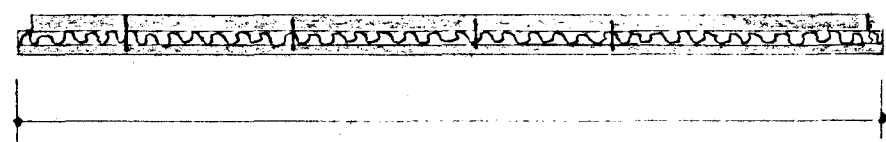

V2

F = 4.37 m<sup>2</sup>  
 P = 1600 kg  
 R = 0.65 m<sup>3</sup>

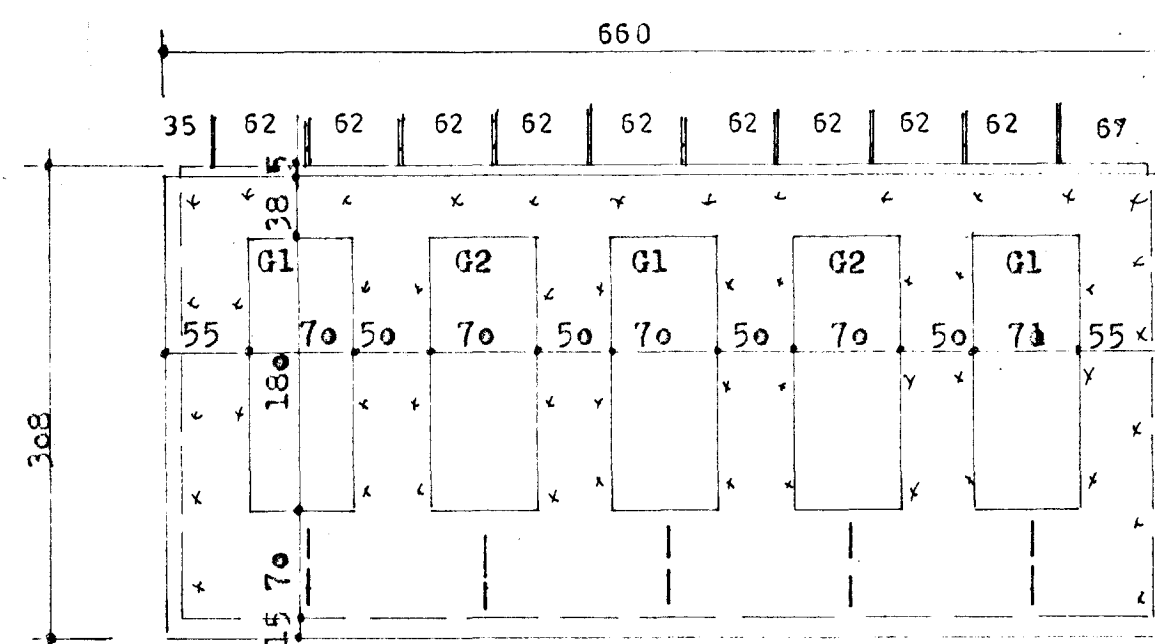
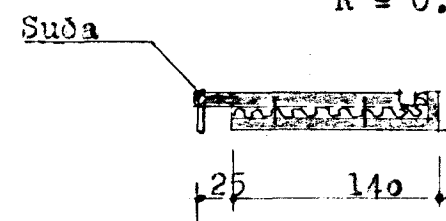

V3

F = 20.33 m<sup>2</sup>  
 P = 5800 kg  
 R = 2.33 m<sup>3</sup>

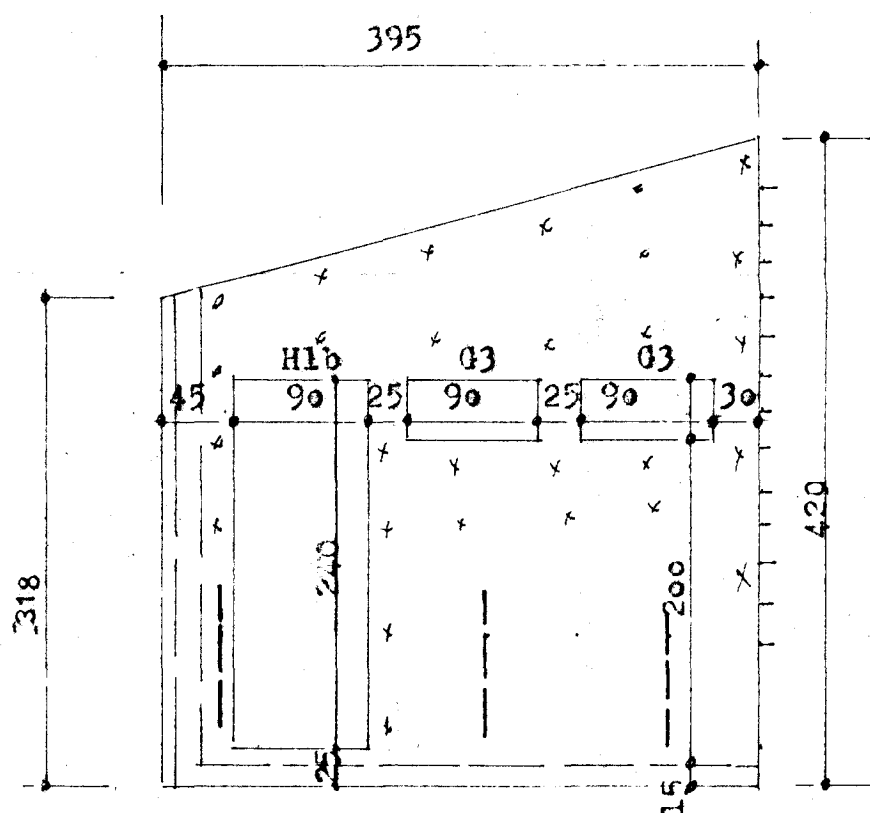
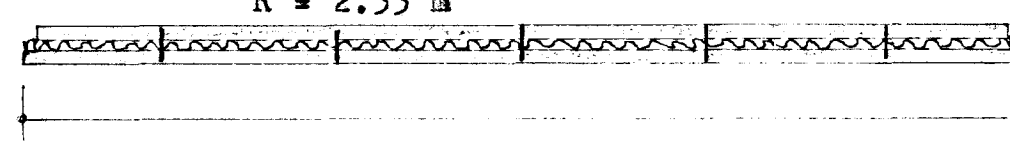

V4

F = 14.67 m<sup>2</sup>  
 P = 5050 kg  
 R = 2.03 m<sup>3</sup>

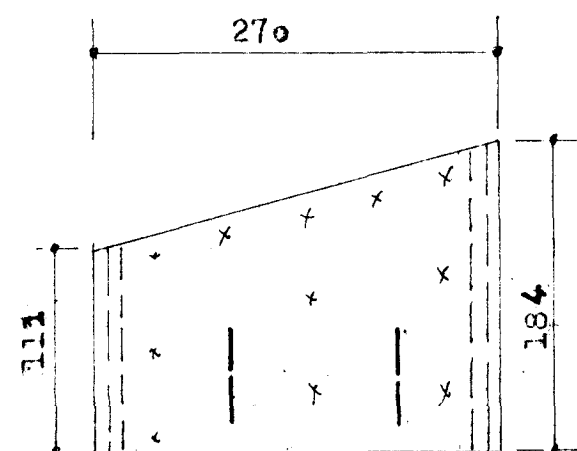
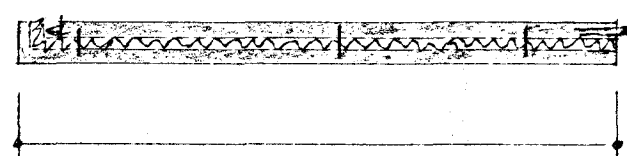

V5

F = 2.84 m<sup>2</sup>  
 P = 1100 kg  
 R = 0.44 m<sup>3</sup>

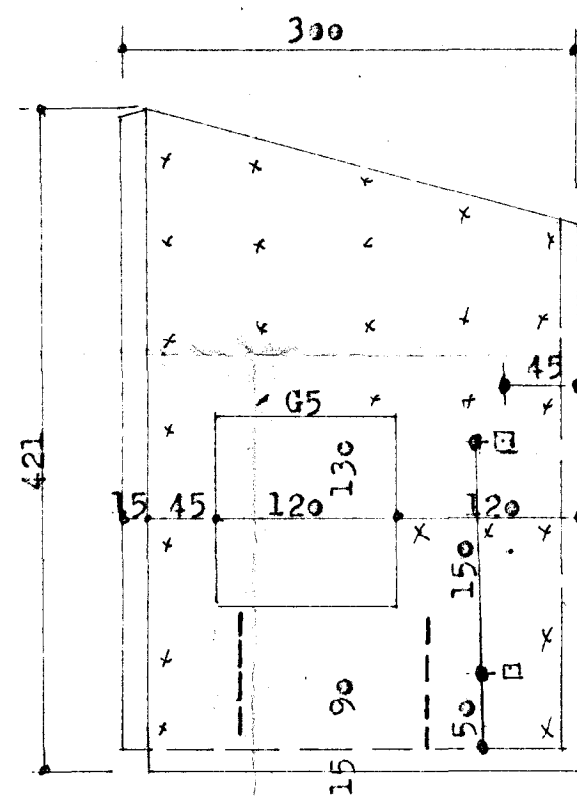
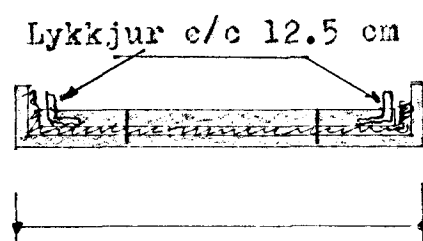

V6

F = 11.52 m<sup>2</sup>  
 P = 4150 kg  
 R = 1.66 m<sup>3</sup>

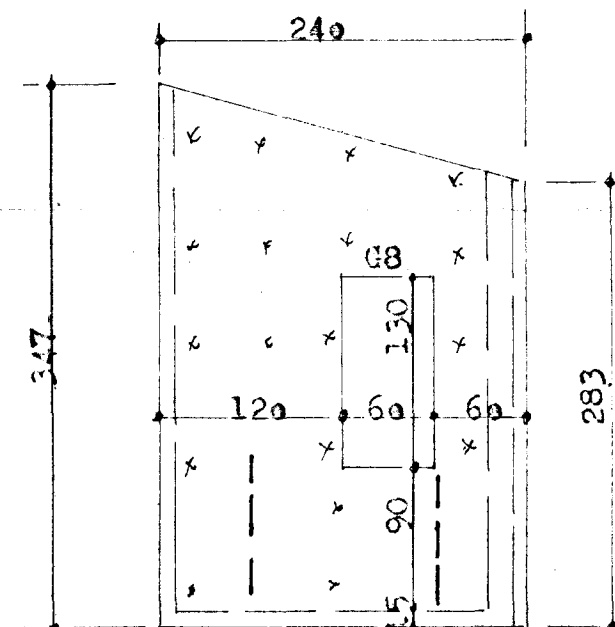
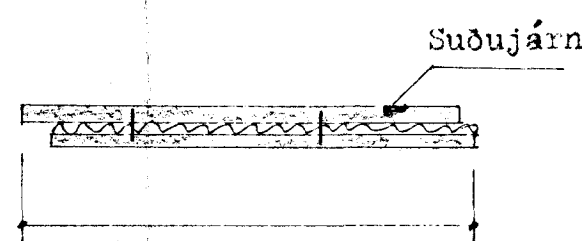

V7

F = 7.56 m<sup>2</sup>  
 P = 2750 kg  
 R = 1.09 m<sup>3</sup>

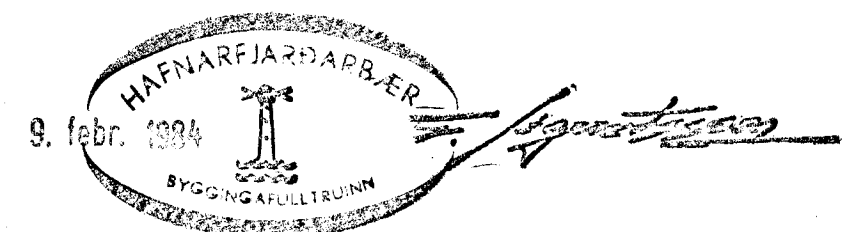
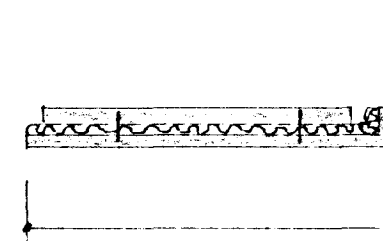

VERKHÖNNUN  
 VERKFRÆÐI- OG TEIKNISTOFA

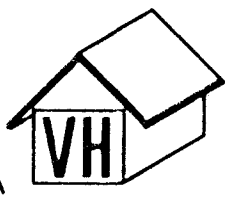

Brautarholti 20 Reykjavík Sími 91-16820

Verknr. 120 Teiknad:  
 Teiknr. 105 Hannad:  
 Mælikv.: 1: 50 Samþykkt: S. Ingólfsson  
 Dags. 11.10.1983 Breytt:

Verkefni: Álfaberg 20 Hafnarfirði

Heiti teikn.: Utvegjæsingar V1 - V3