

Suðvesturhlíð fyrir breytingu  
1 : 100

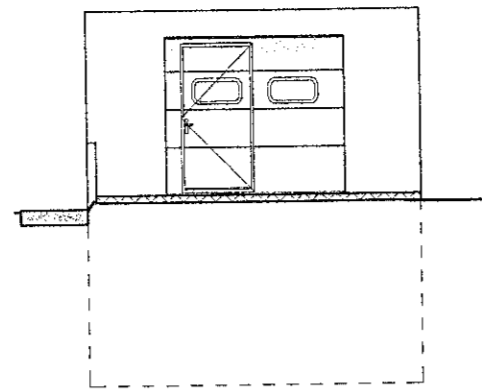

Suðausturgafi fyrir breytingu  
1 : 100

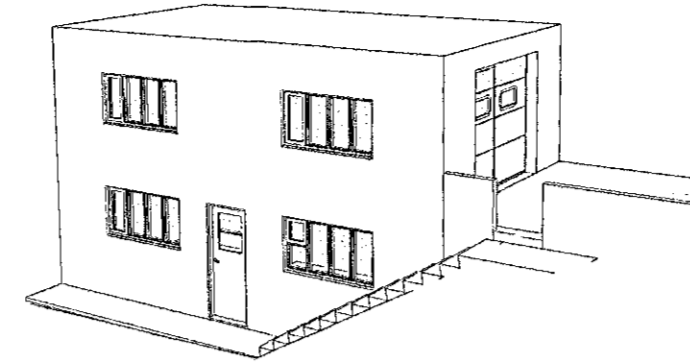

3D ásýnd fyrir breytingar

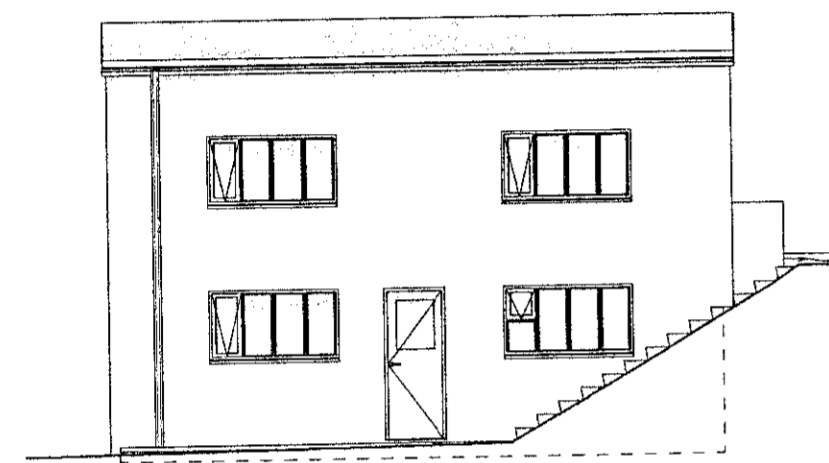

Suðvesturhlíð  
1 : 100

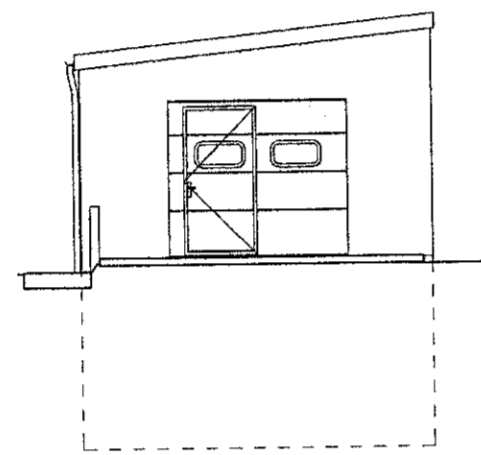

Suðausturgafi  
1 : 100

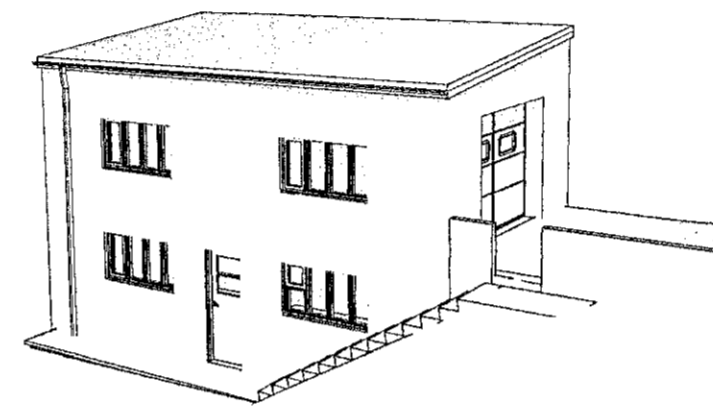

3D ásýnd

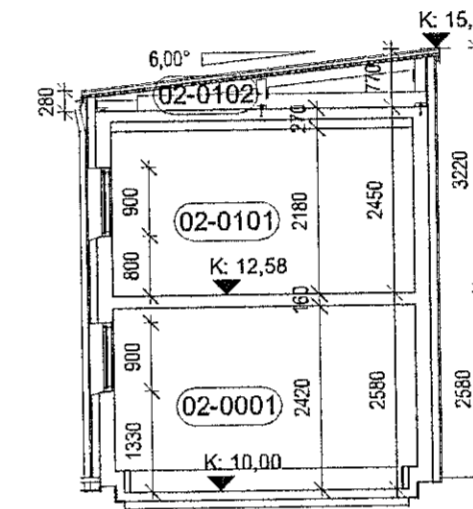

Snið A  
1 : 100

**Skýringar**

**Brunatákn**  
R: Burðargeta í mínútum  
E: Heilleiki í mínútum  
I : Einangrun í mínútum  
S: Reykþétting  
C: Sjálflokandi hurð

- REI 60 Dæmigerð brunamerking fyrir burðarvegg
- EI230-CSm EI,30-CSm hurðamerking
- GN Gólfniðurfall
- LR Loftræsing
- SL Slökkvitæki
- RS Reykskynjar
- ➔ RL Rýmingaleið
- ➔ BO Björgunarop
- ▼ Kóti á sniði
- ⊙ Kóti á grunnmynd
- ↔ Loftræsirit/-rauf í eða undir hurðaffleka
- LM Lóðarmörk
- G Kóti við götu/gangstétt
- L Leiðbeinandi hæðarkóti lóðar

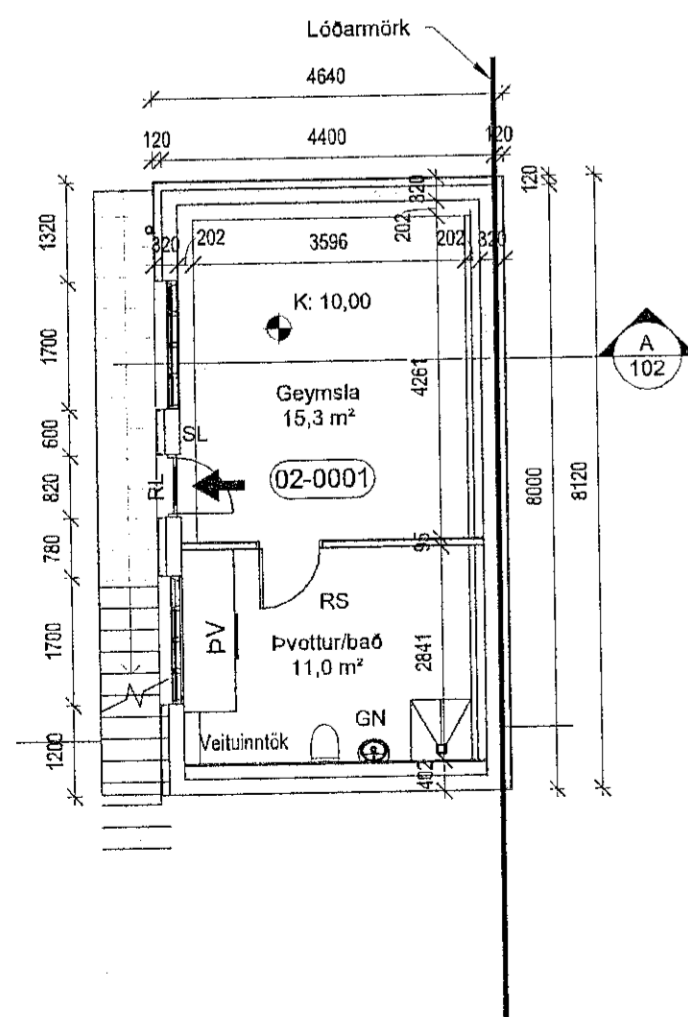

Grunnmynd - Geymsla  
1 : 100

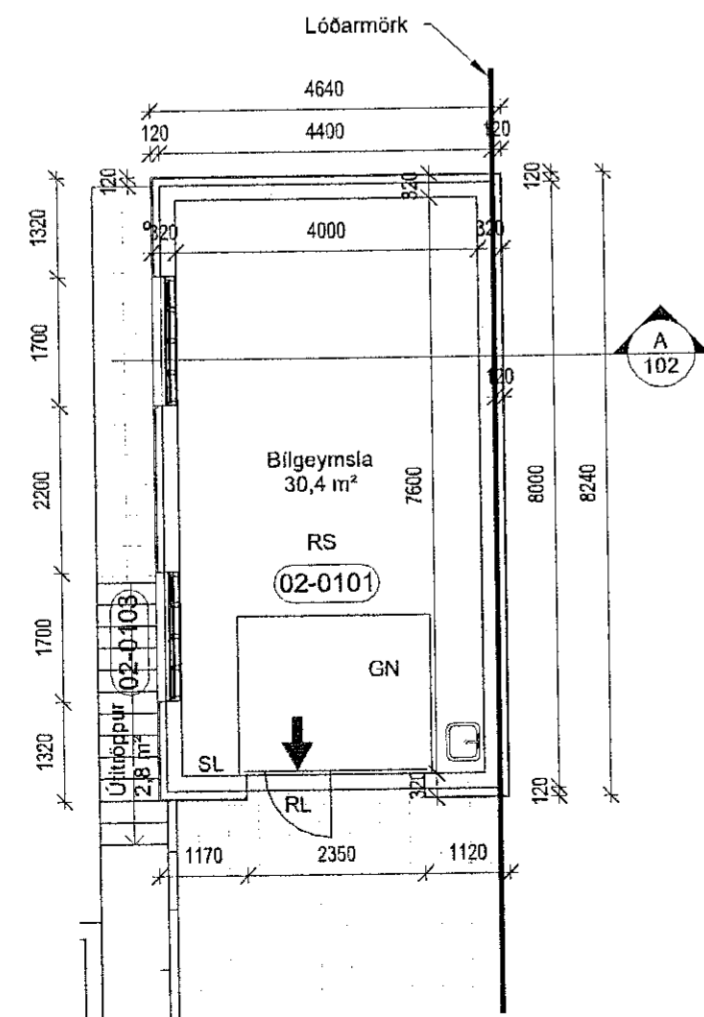

Grunnmynd - Bilgeymsla  
1 : 100

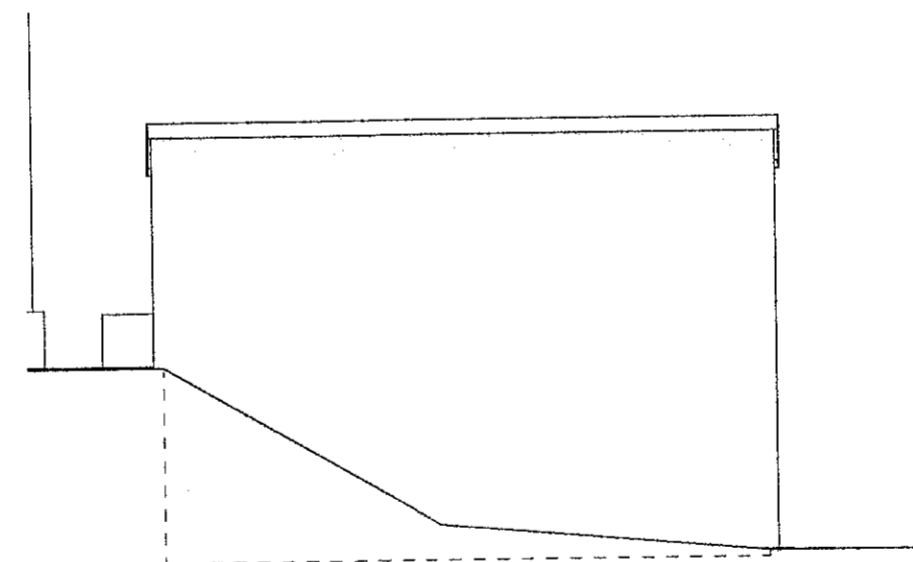

Norðausturhlíð  
1 : 100

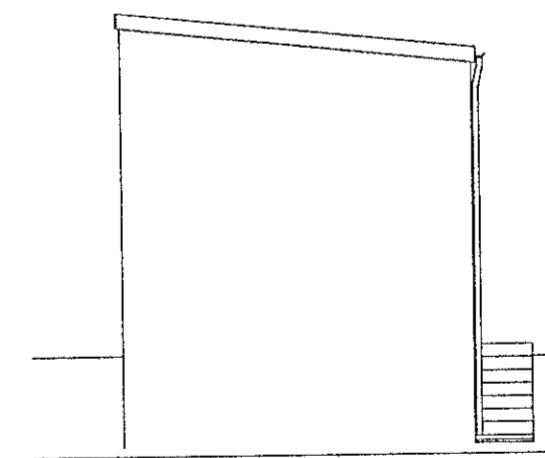

Norðvesturgafi  
1 : 100

Útg.	Dags.	Skýring	Br.af.
		Leynisbraut 33, 300 Akranesi Sími: 8976307 Kt: 450109-2830 gudlaugurm@gmail.com	
Verkheiti: <b>Bilgeymsla og geymsla</b>			
Heimilisfang: Suðurgata 62, Hafnarfirði			
Verktegund: Breytingar úti, klæðning og einhalla þak			
Landeignanúmer: L122556		Staðgreinir: 1400-1-84700620	
<b>ADALUPPDRÁTTUR</b>			
<b>Grunnmyndir, snið og útlit</b>			
Hannað af:	GIM	Matshluti:	02
Teiknað af:	GIM	Mælikvarði:	As indicated
Yfirfarið af:		Dagsetning:	10.08.2020
Hönnuður: Guðlaugur I. Mariasson byggingarfræðingur BFI Kt: 160970-4729			
Hönnunarstjóri: <i>Sigrún Þrymadóttir</i>			
<b>20-107-</b>	-	-	<b>102</b>
Verknúmer	Svæði	Áfangi	Ábyrgð
Númer		Útgáfa	
HÖNNUÐUR ÁSKILUR SÉR ALLAN RÉTT Á TEIKNINGUM - FJÓLFÓLDUN ER HÁÐ SKRIPLEGU SAMÞYKKT			

