

Brunapétting á stállögn í gegnum steypnan vegg og gólf

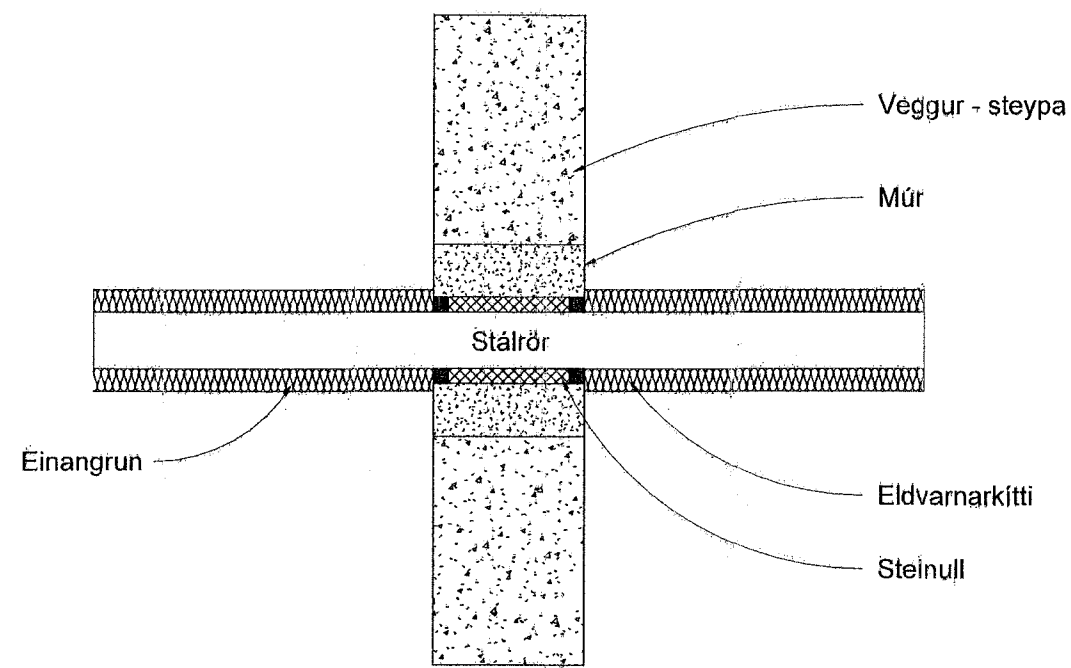

Brunapétting á stállögn í gegnum léttan vegg

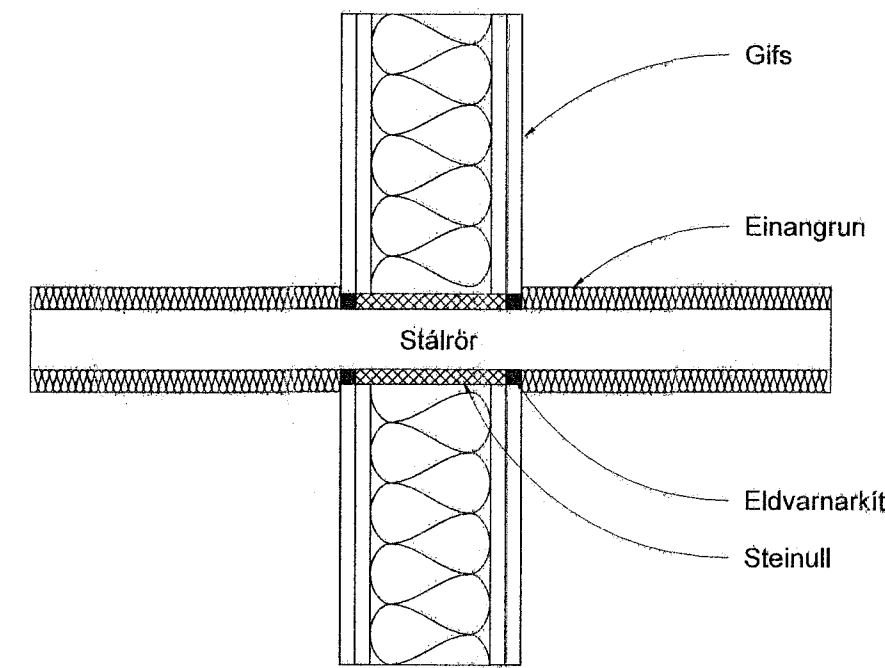

Brunapétting á steypujárnslögn í gegnum steypnan vegg og gólf

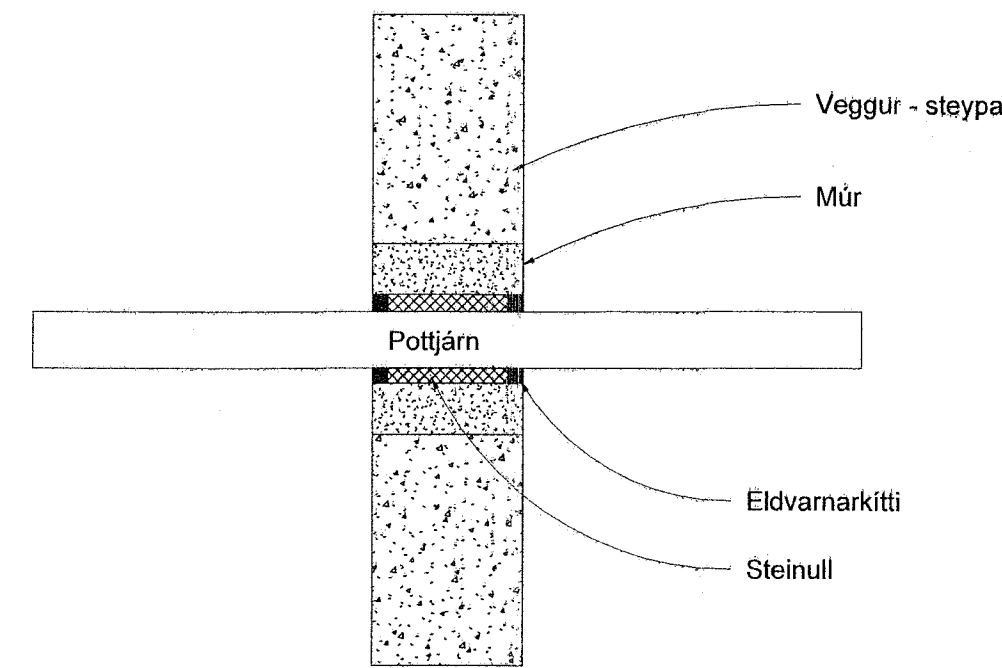

Brunapétting á steypujárnslögn í gegnum léttan vegg

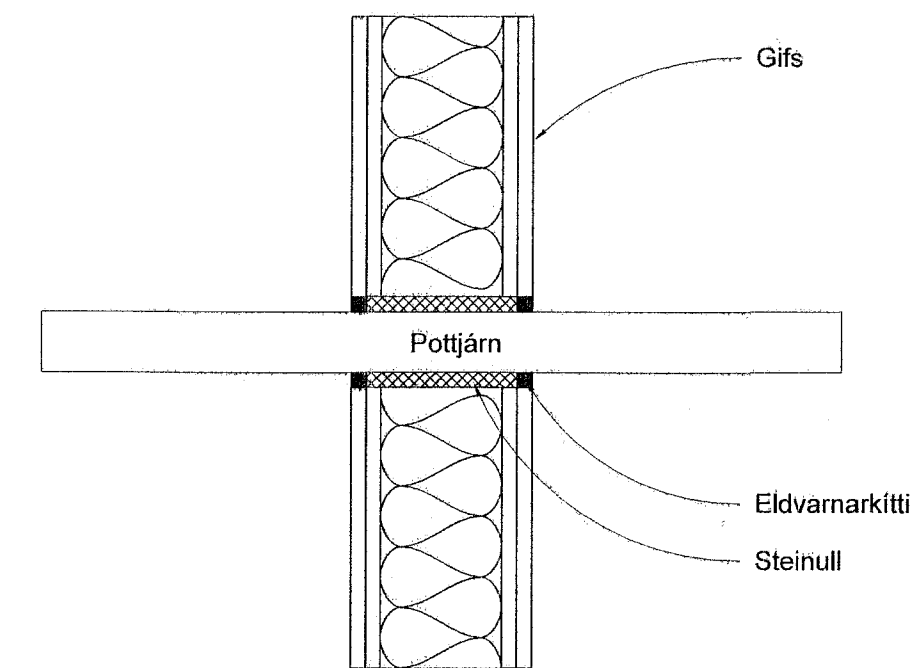

Brunapétting á plastlögn stærri en Ø32mm í gegnum steypnt gólf

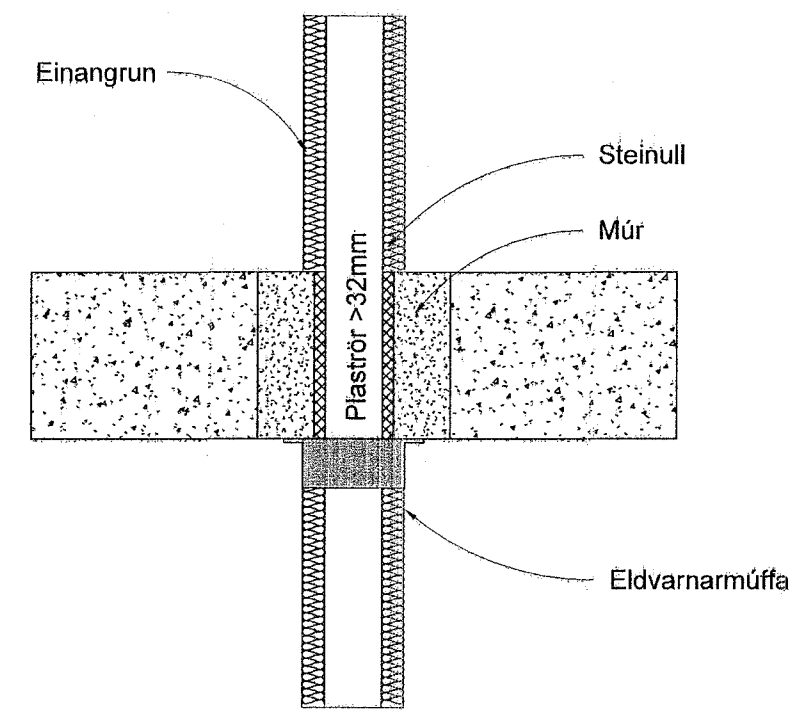

Brunapétting á plastlögn stærri en Ø32mm í gegnum steypnt gólf innan lagnaskakts

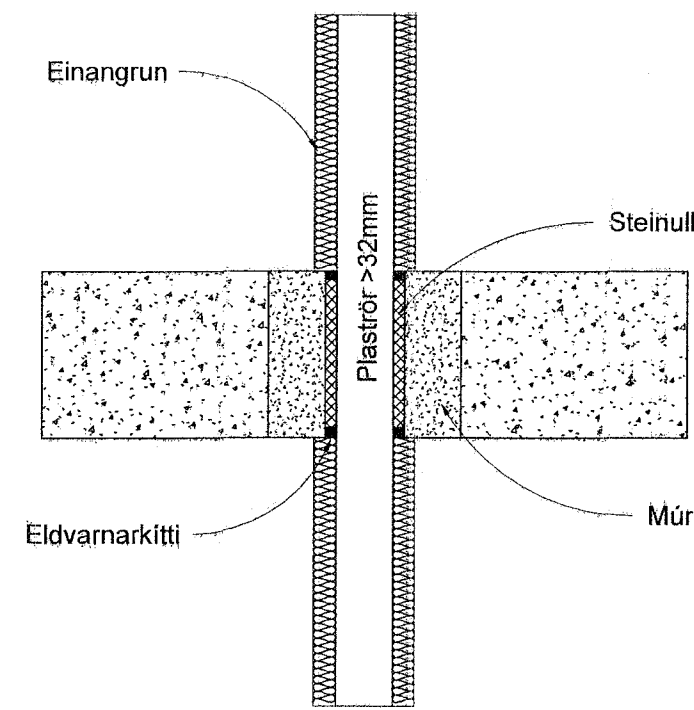

Brunapétting á plastlögn stærri en Ø32mm í gegnum steypnan vegg

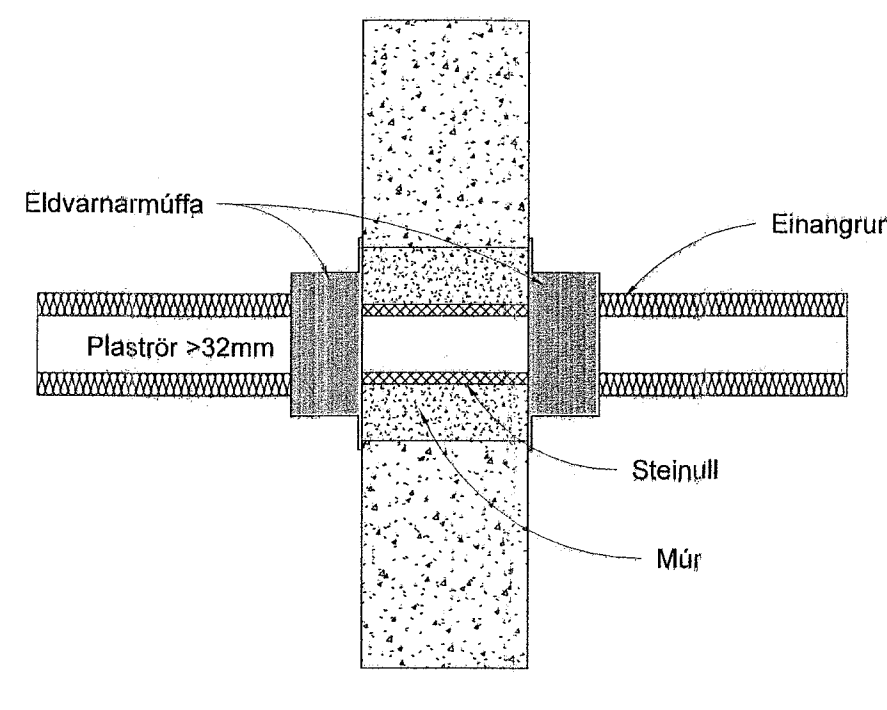

Brunapétting á plastlögn stærri en Ø32mm í gegnum léttan vegg

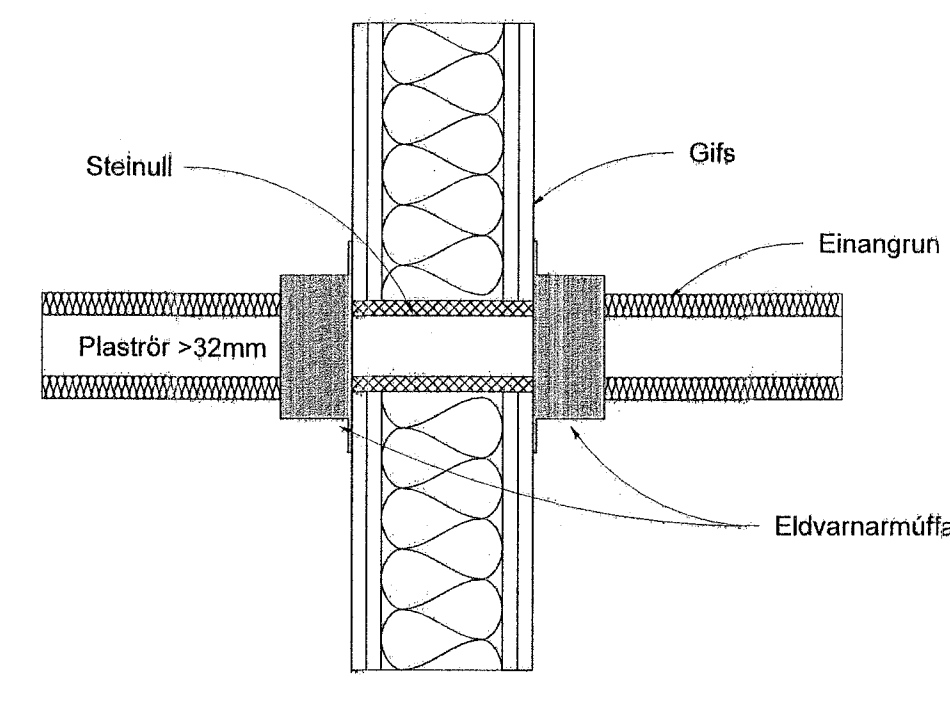

Brunapétting á loftræstilögn í gegnum steypnt gólf í lagnaskakti

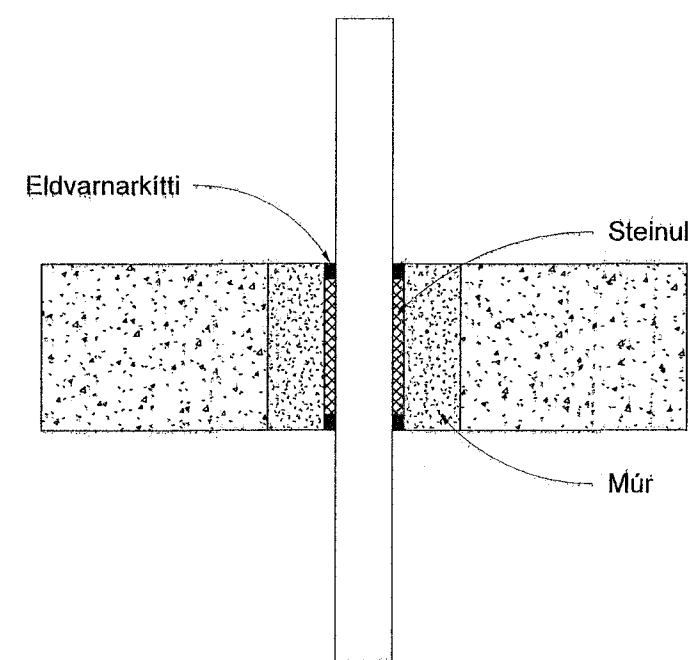

Brunapétting á loftræstilögn í gegnum steypnt gólf utan lagnaskakts

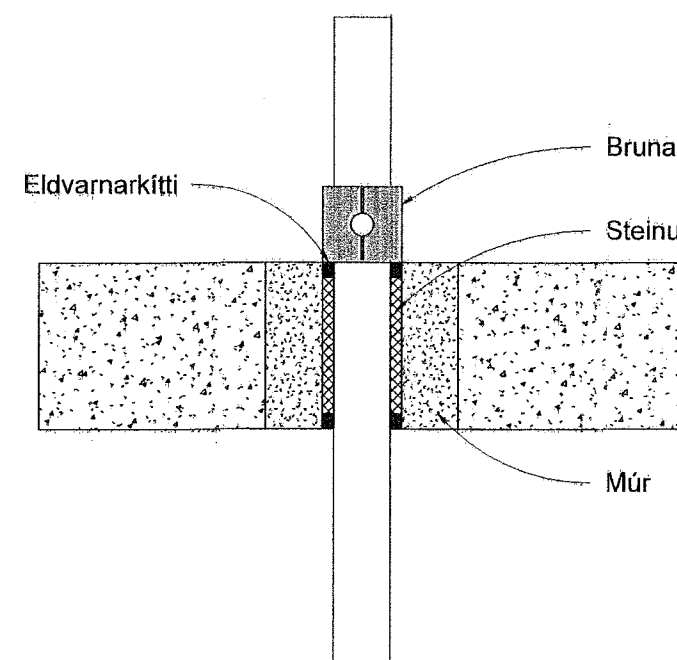

Brunapétting á loftræstilögn í gegnum steypnan vegg

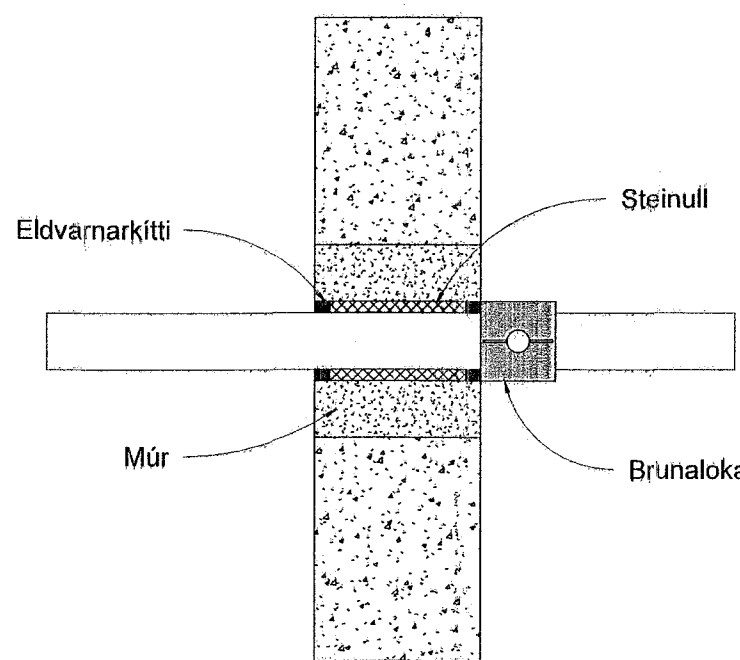

Brunapétting á loftræstilögn í gegnum léttan vegg

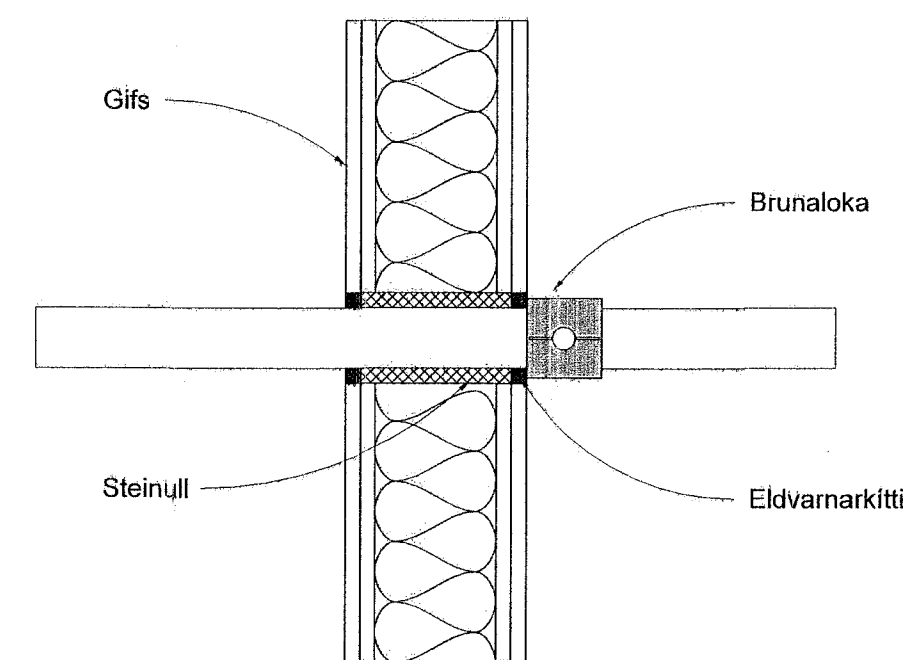

MERKINGAR (Í SAMRÆMI VÍÐ ÍST. 64, 65, 68 OG GILDANDI REGLUGERÐIR)

1. BRUNNAR O.F.L.

- BG BENSÍNGILDRÁ, OLÍUGILDRÁ
- BR BRUNNUR
- GN GÓLFNIÐURFALL
- GNG GEGNUMSTREYMISNIÐURFALL
- GNB GÓLFNIÐURFALL m/BLÖÐKU
- GN m/LL GÓLFNIÐURFALL m/LYKTARLOKU
- NF NIÐURFALL
- SF SANDFANG, SANDGILDRÁ
- SN SVALANIÐURFALL
- PN ÞAKNIÐURFALL
- KB KÓTI BOTN Á BR EÐA NF
- HRL HREINSILOK / HREINSISTÚTUR
- FS.X FALLPIPA NR. X
- K.n.h KÓTI NEDRI HÆÐ
- K.e.h KÓTI EFRRI HÆÐ
- VL VATNSLÁS
- HRB HREINSIBRUNNUR
- J PÍPUR STEYPUJÁRN
- ST PÍPUR STEINSTEYPA
- PVC PÍPUR POLYVINILKLÓRÍÐI
- PP PÍPUR POLYPROPYLEN
- PE PÍPUR POLYETHYLENE
- PB PÍPUR POLYBUTYLENE

INNTÖK VEITNA ERU GEGNUM GÓLF OG VEGGMÁTA SKV. LEIÐBEININGUM OR

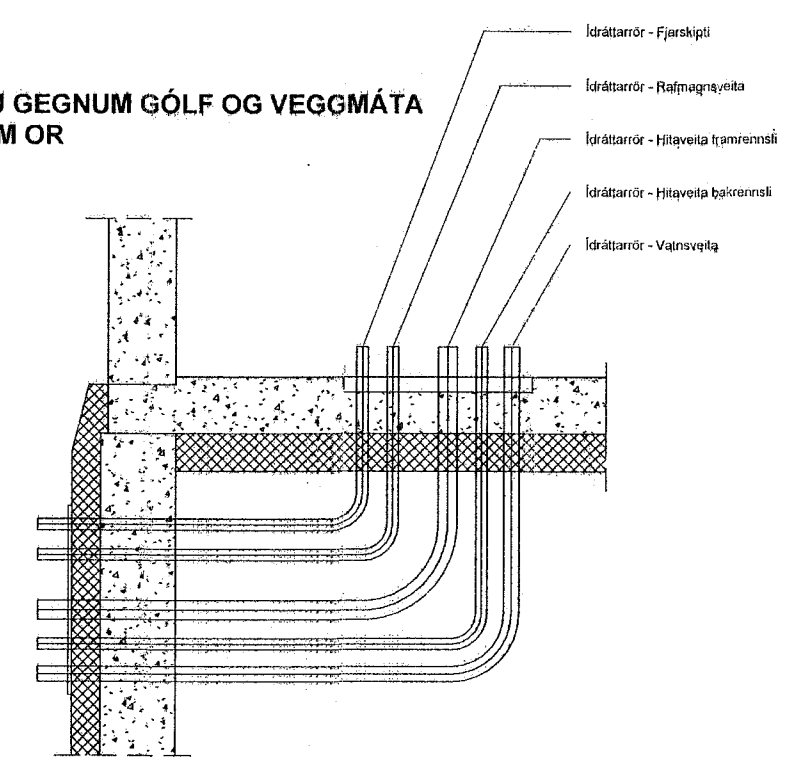

FRÁGANGUR INNTÖK VEITNA [1:20]

VERKFRÆÐISTOFA

NNE VERKFRÆÐISTOFA ehf
Hæðarnesi 6 - 201 Kópavogur Ísland
Sí. 855-3077 / 899-3577
Kl. 460421-0470, nne@nne.is, www.nne.is

BAUGHAMAR 1 - Mhl.01
221 HAFNARFJÖRÐUR

SKÝRINGAR - LAGNIR
SÉRUPPDRÁTTUR - FRÆNNISLIS- OG LOFTRÆSILAGNIR

Hönnun:	NG	Verknúmer:	22027
Teiknað:	NG	Mælikvæði:	1:10
Yfirfarið:	SJ	Dagsetning:	27.04.2023
Samþykkt:	Hákon Órn Ómarsson Kl. 300577-3189	Teikn.nr.:	P0-02

Áritun hönnunarstjóra:	Jóhann Elíjar Jónsson Kl. 090882-3549	Útgáfa:	1
------------------------	--	---------	---

Útgáfa / Dagsetning skýringsdráttar: b / 29.03.2023

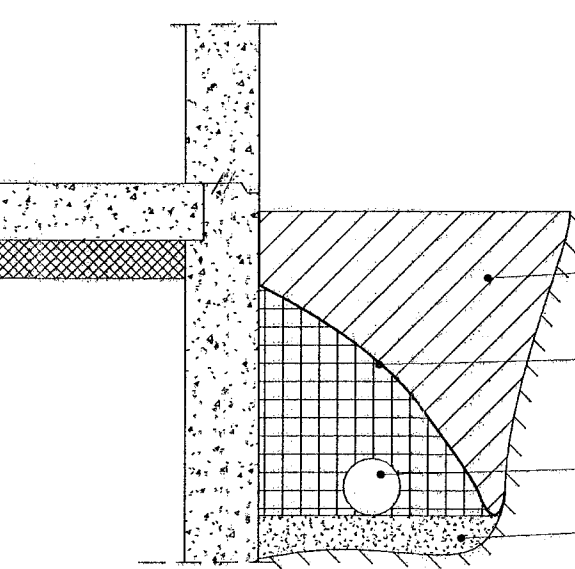
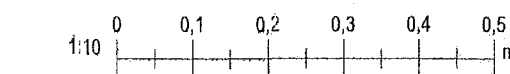

FRÁGANGUR DRENLAGNAR [1:20]