

H01
2 stk.

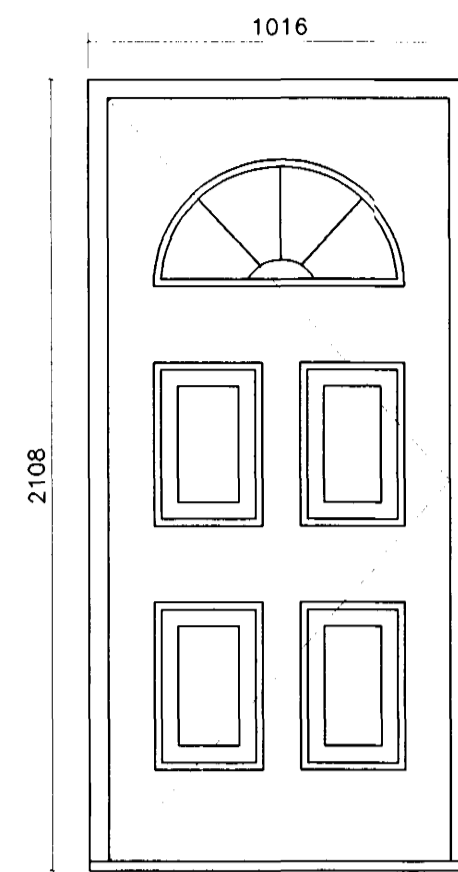

H02
2 stk.

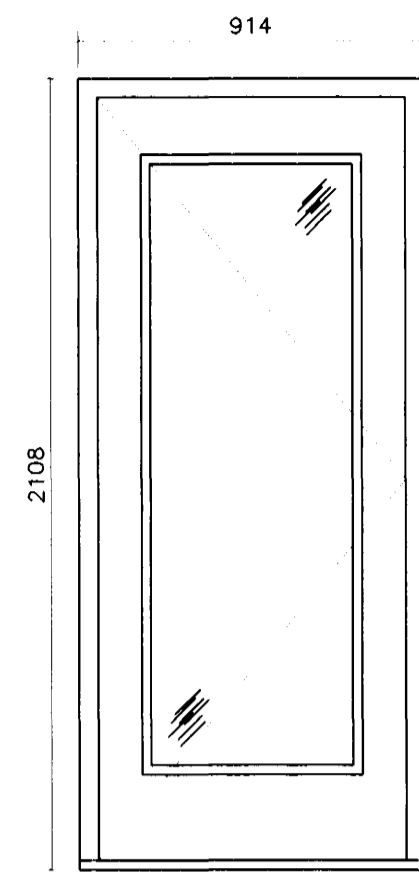

H03
2 stk.

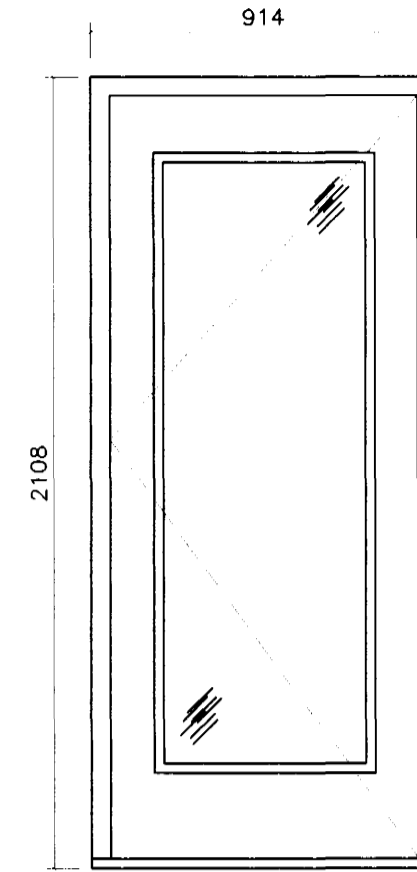

H04
2 stk.

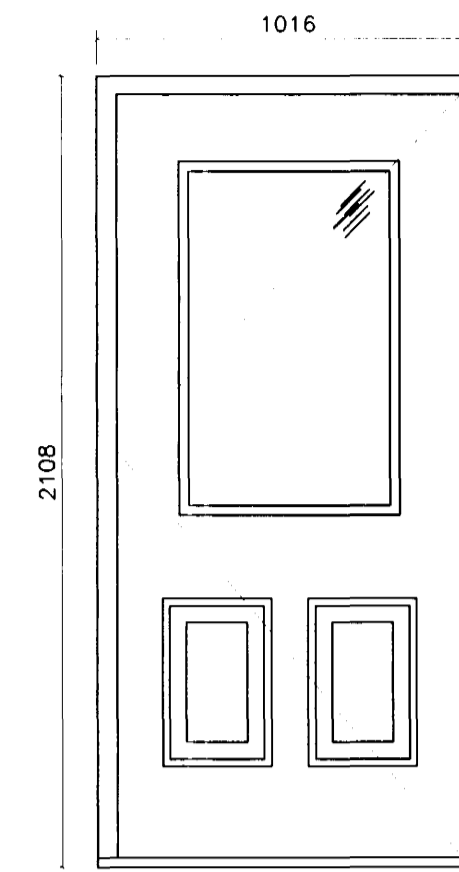

H05
1 stk.

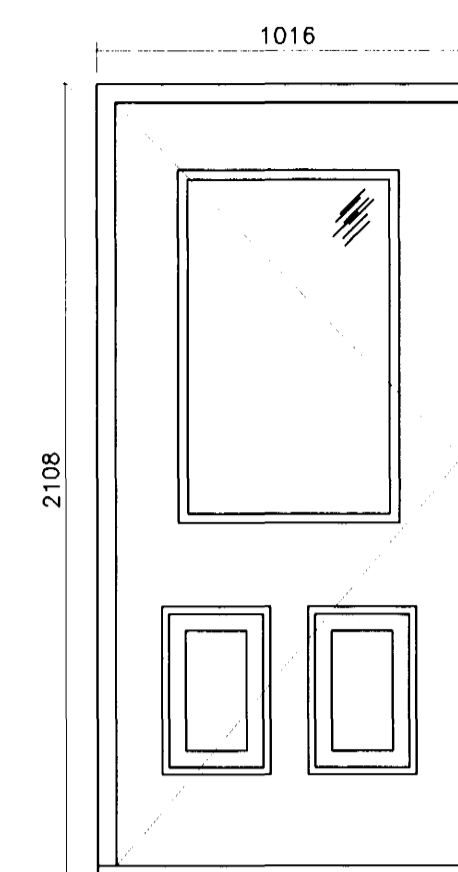

H06
2 stk.

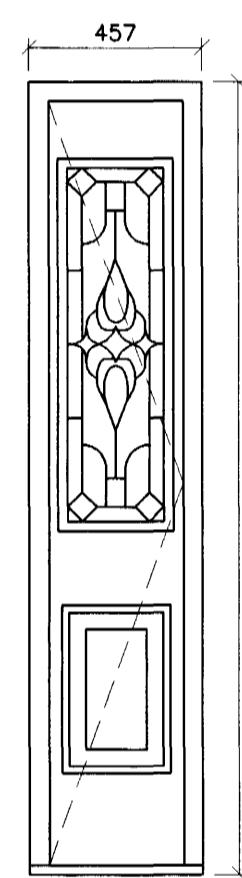

G01
1 stk.

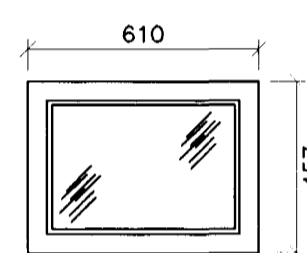

G02
1 stk.

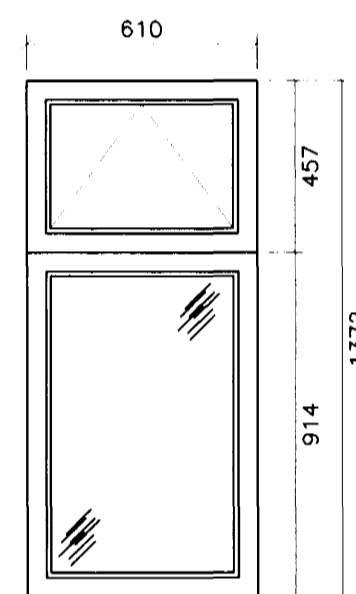

G03
6 stk.

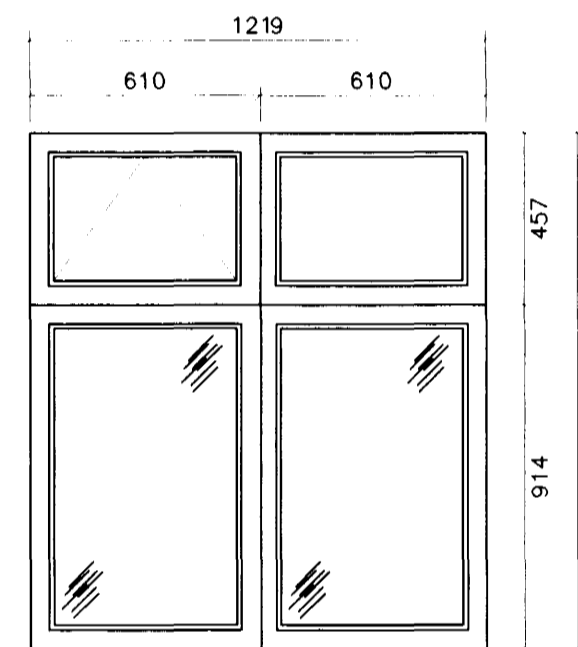

G04
8 stk.

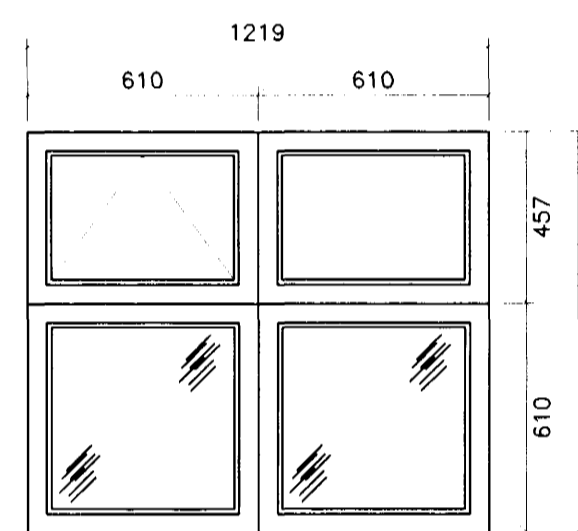

G05
2 stk.

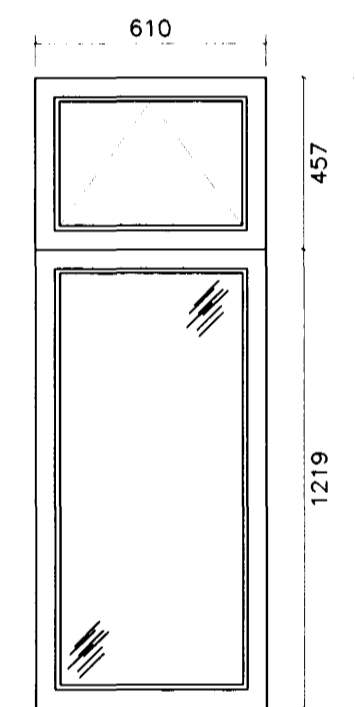

G06
4 stk.

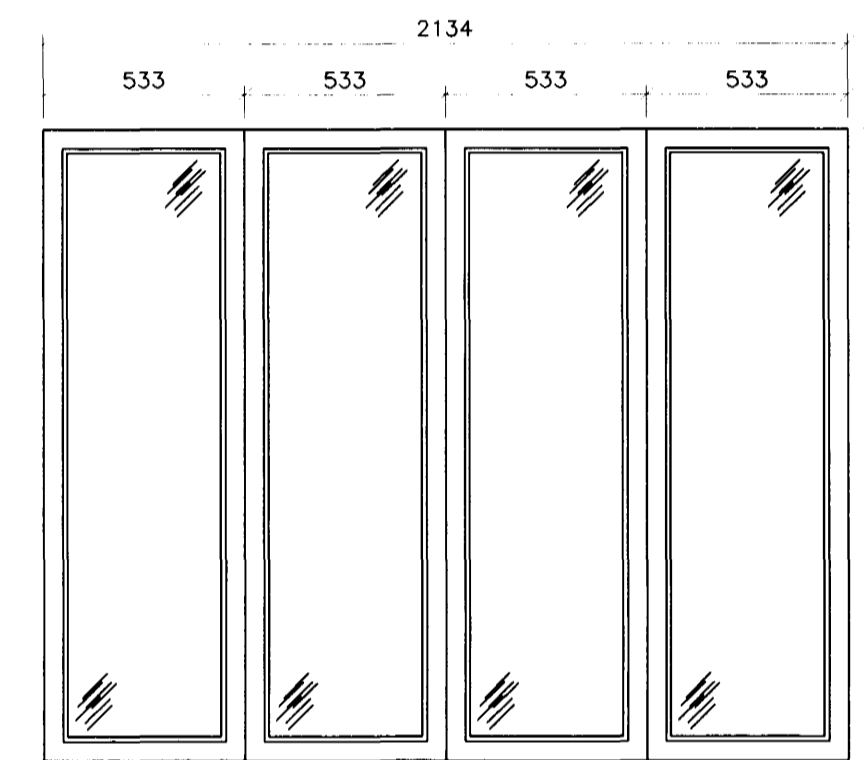

G7
4 stk.

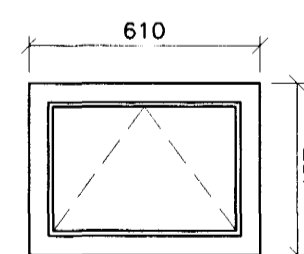

G08
2 stk.

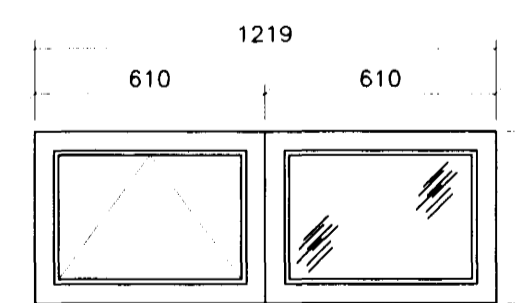

G09
2 stk.

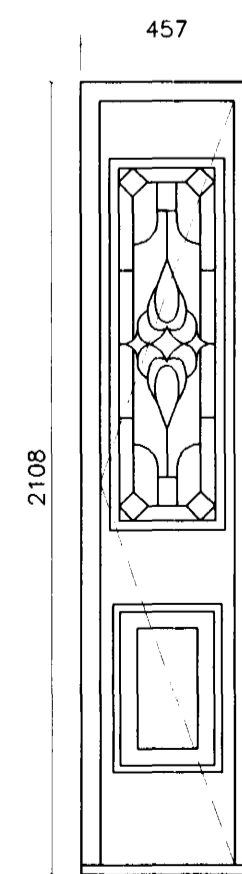

G10
1 stk.

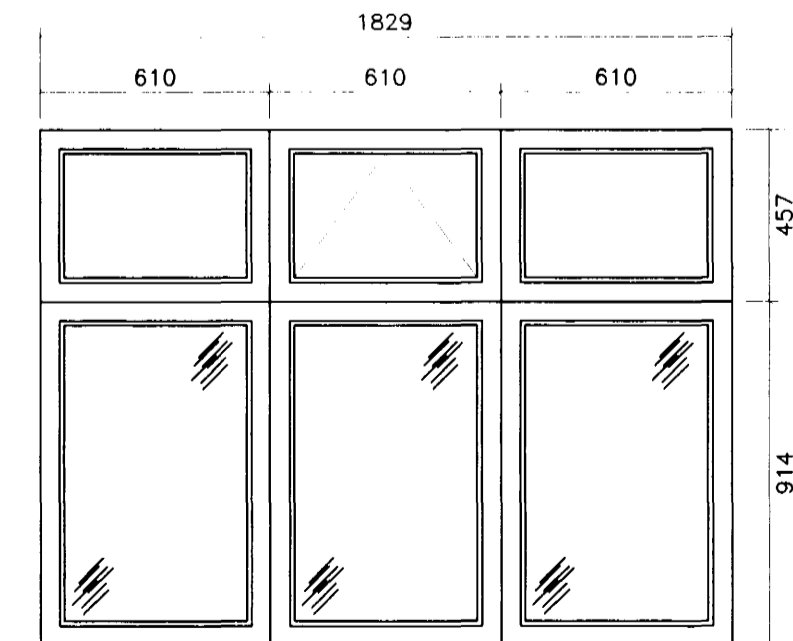

G11
8 stk.

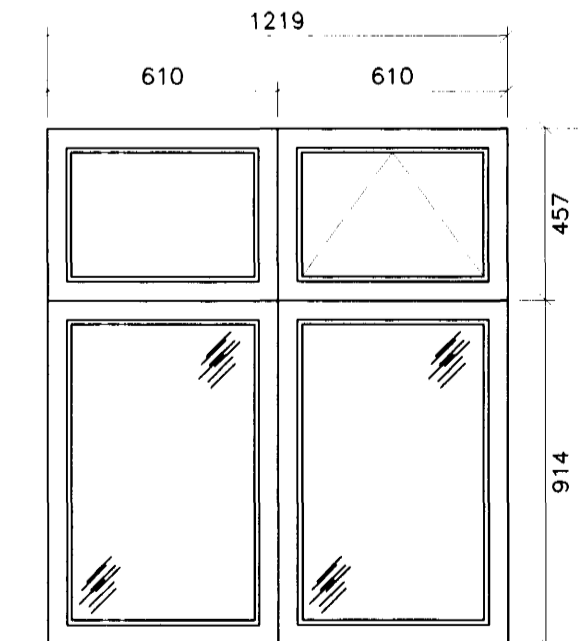

G12
2 stk.

SKÝRINGAR

ALMENNT:

- Gluggar eru plastgluggar úr hvítum PVC-prófflum
- Gler er tvöfalt einangrunargler með einangrunarfilmu á innra byrði annars glersins. Loftunarbíl er fyllt Argon-gasi
- Hurðir eru úr heitgaivanhúðuðum, hvítmáluðum stálpötum beggja vegna með einangrunarkjarna úr polyurepan

Samþykkt þann
22. NOV. 2000
Byggingafulltrúi í Hafnarfirði
F.h. Sigurbjartur Halldórsson

<p>Spruce Capital Design BUILD WITH US...</p> <p>598A Tonkin Road, Prince George, BC, Canada, V2C 4L4 Telephone: (250) 541-2079 Fax: (250) 562-7346</p>	<p>Verk nr. 99-05</p> <p>Dagsetning 21. NOVEMBER 2000</p> <p>Kvarði 1:20</p> <p>Vákur fyrir Kemur í stöð</p>
	<p>Hannað GÚSTAF B. Ó. Teiknað TRAUSTI H.</p> <p>Útgáfa A Blað 1 AF 1</p> <p>Tekning nr. A-11</p> <p>200759-7619</p>
<p>Á aðalhönnuðum</p> <p><i>Andri B. Ólafsson</i></p>	