

GRUNNMYND. M. 1:50.

PLÖTUR YFIR KJALLARA. 1:50.

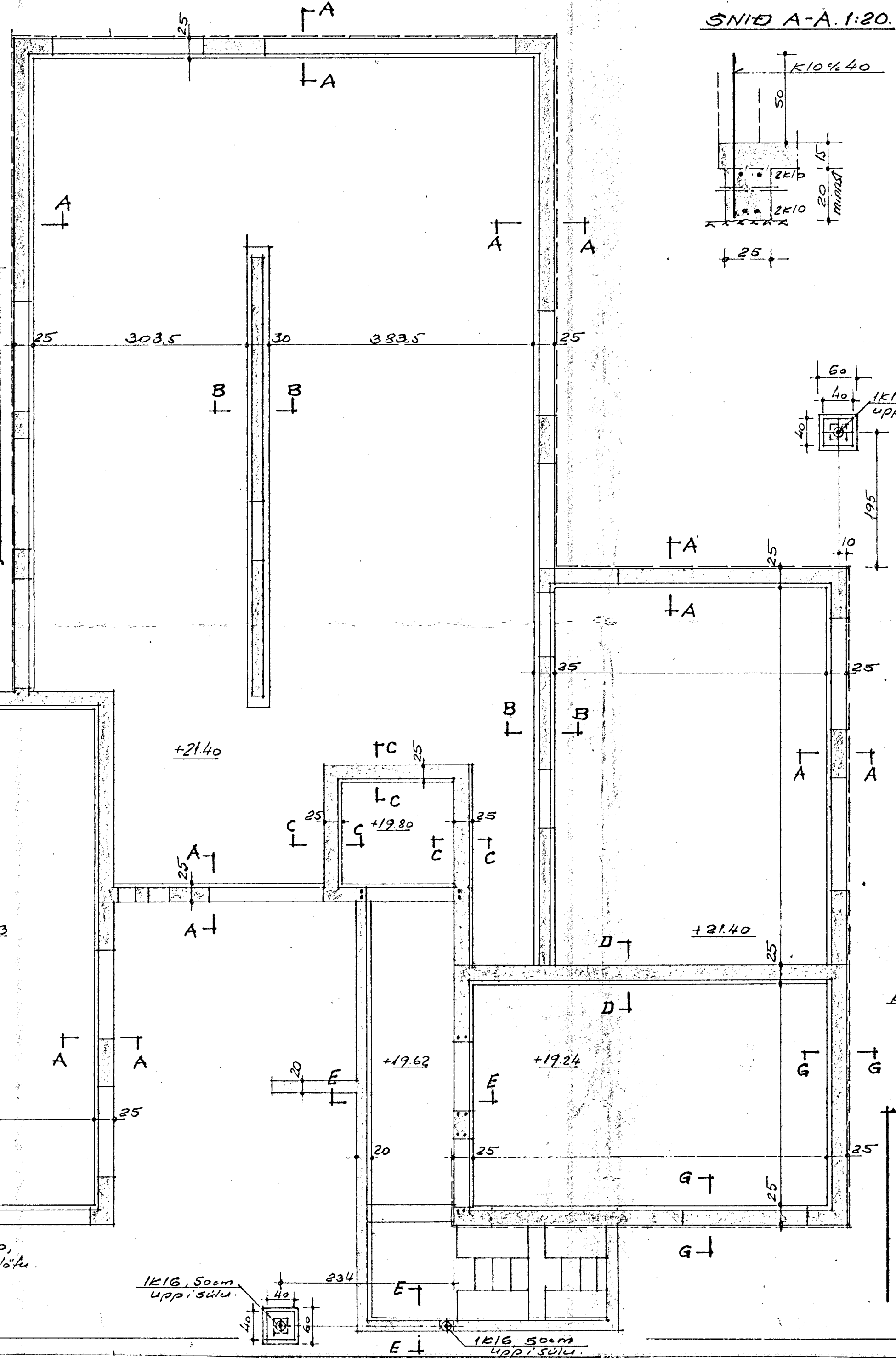

SNID A-A. 1:20.

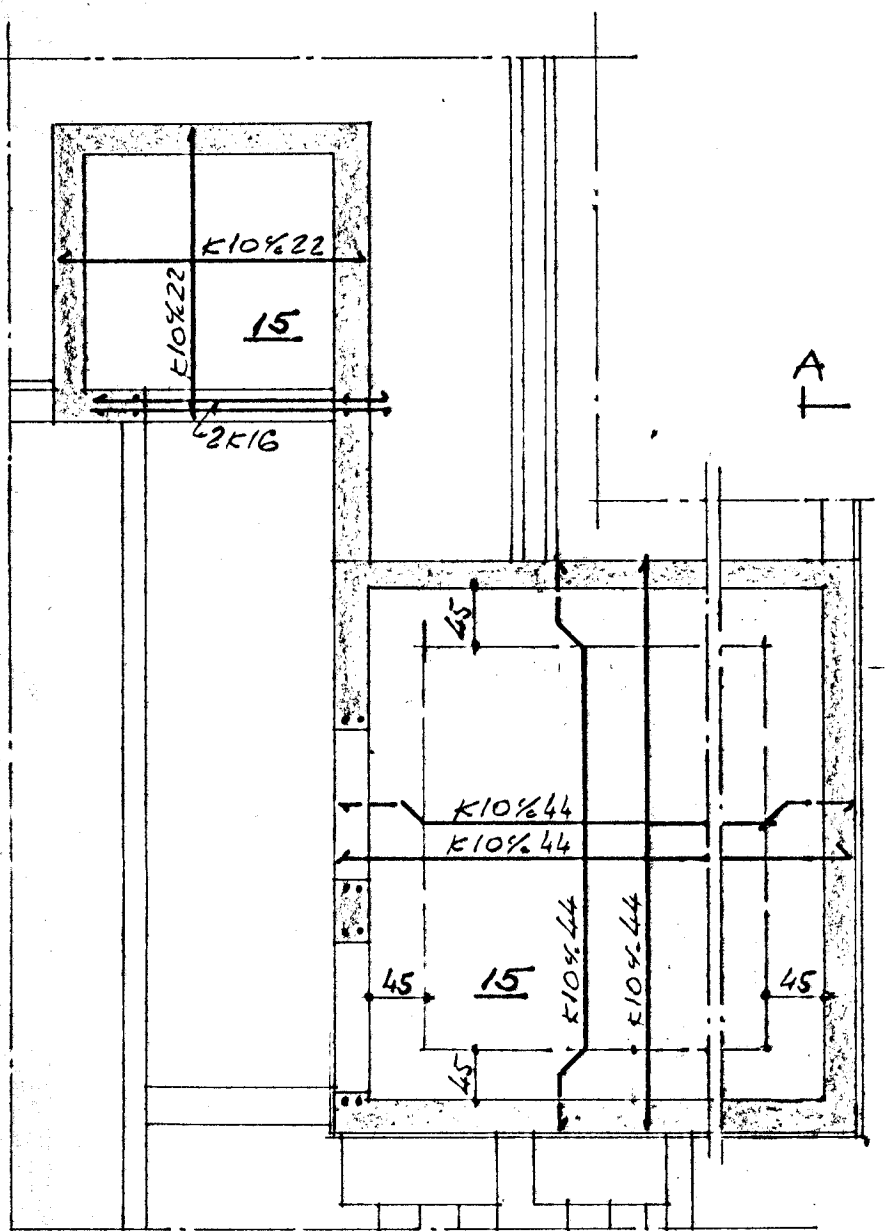
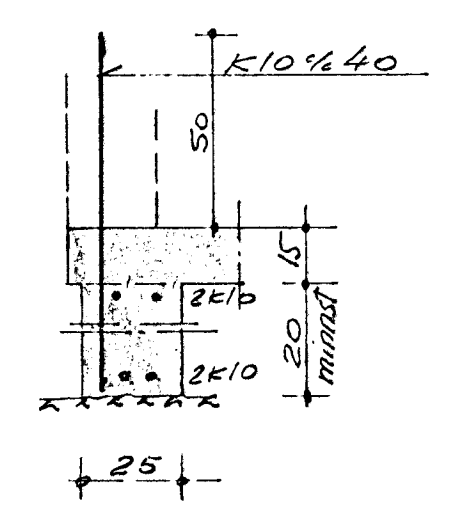

SNID B-B. 1:20.

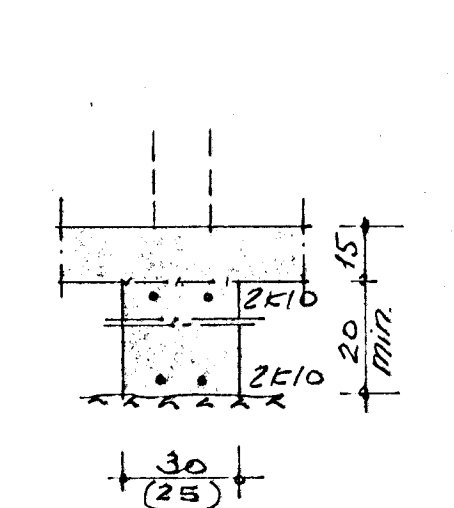

SNID C-C. 1:20.

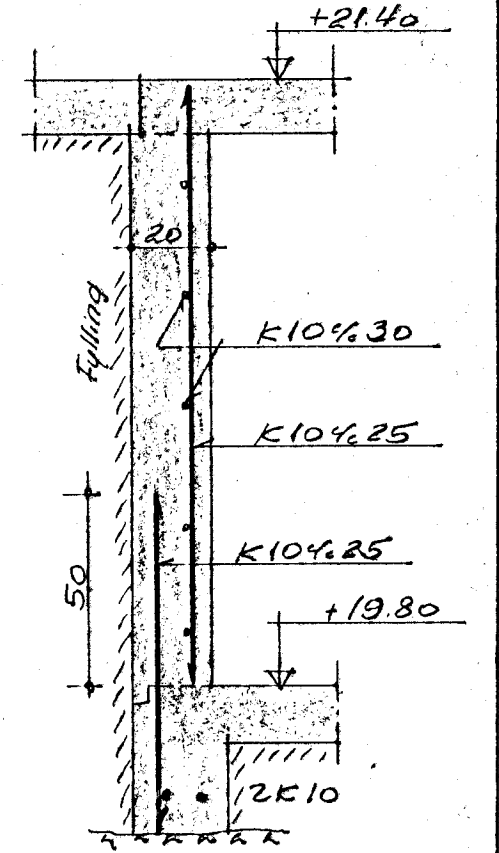

SNID E-E. 1:20.

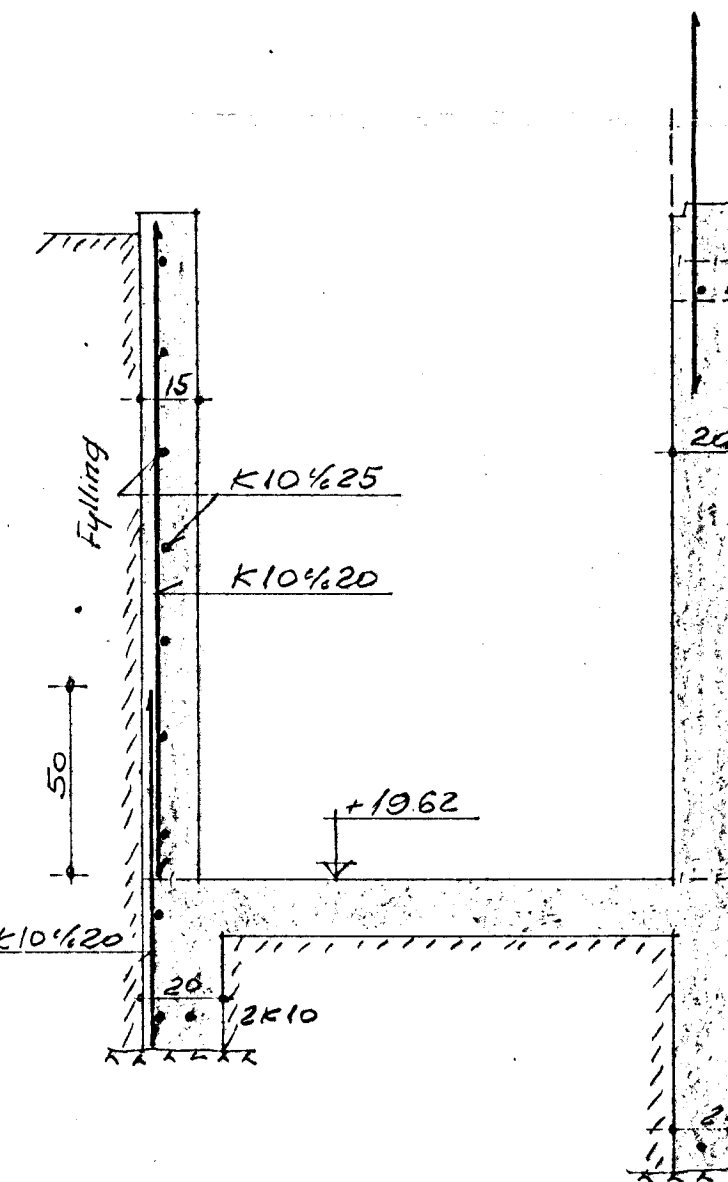

SNID G-G. 1:20.

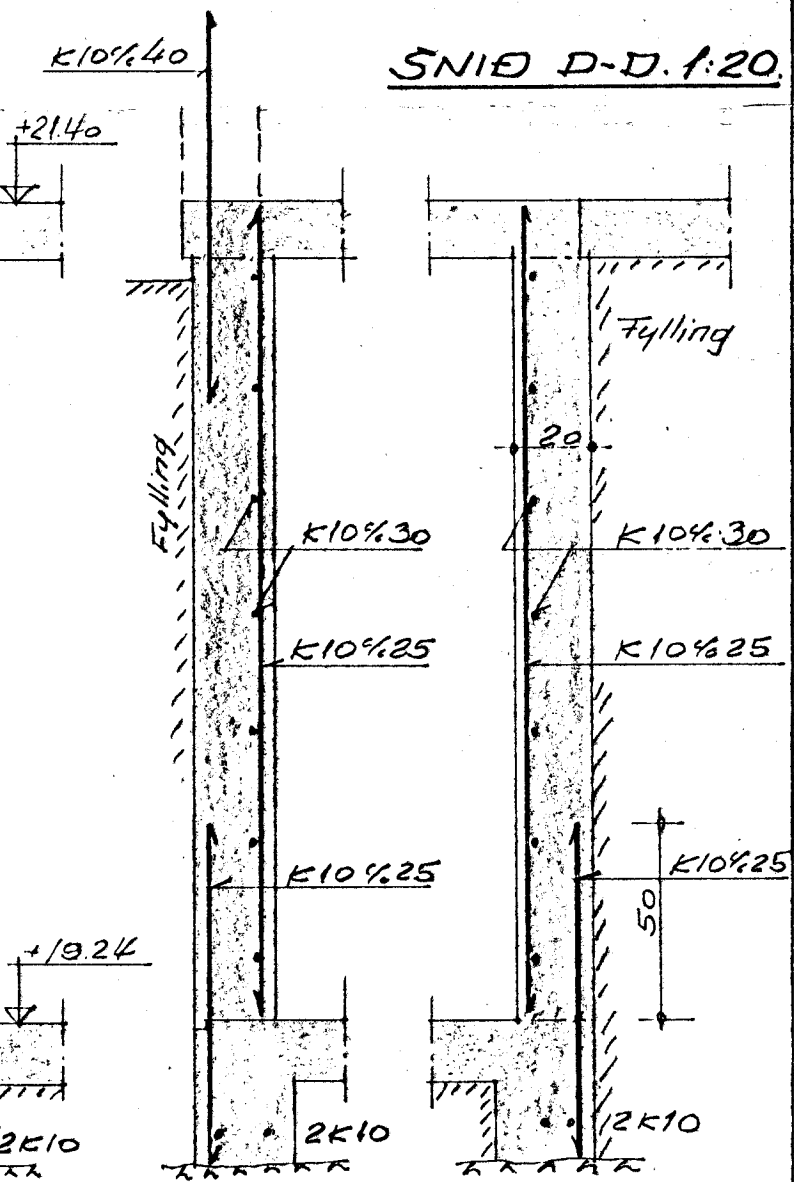

SNID D-D. 1:20.

4K16, L=100, 50 upp úr plötu.

1K16, 50cm upp í súlu.

1K16, 50cm upp í súlu.

SKÝRINGAR.

K merkir kambstól KS-40.
 % — fjarlægð milli járna, miðju á m.
 Undirstrikadur tölur eru plötupykktir.
 Öll járn eru kröktlaus á endum.
 Steypuslyrkleiki K-200.

BLÓMVGANGUR NR. 4.

UNDIRSTÖÐUR.
 KJALLARI.

BRAGI SIGURÐÓRSSON VERKFR.
 SAFAMÝRI 38 - RVÍK.

M. 1:50:1:20	Dr. B.Sj.	
D. 19-9-69	Uppdr. B.Sj.	NR. 7001

Dr. 23/9 1969 B.Sj.