

FYRIR BREYTINGU:

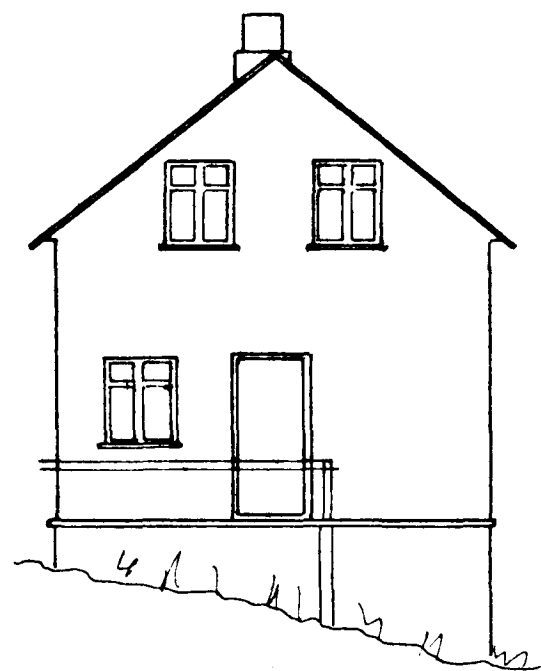

AUSTUR

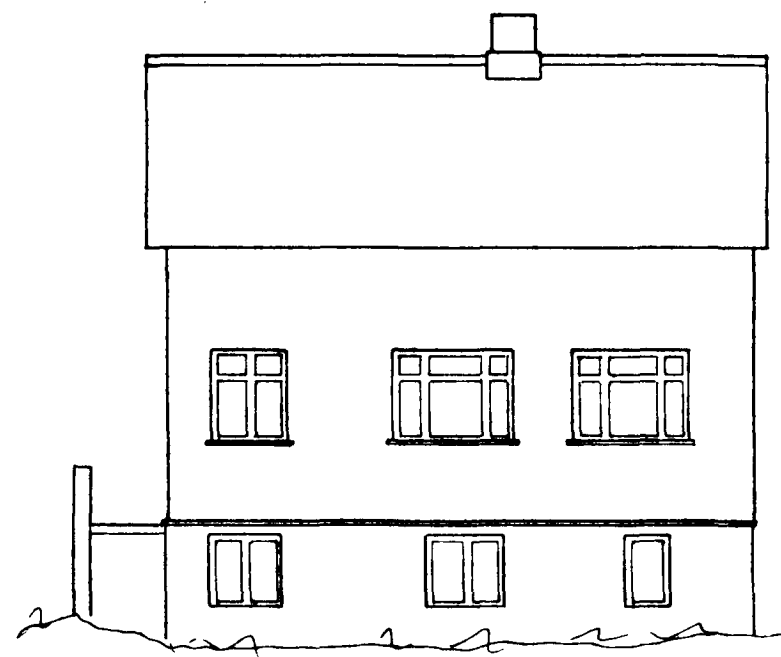

NORÐUR

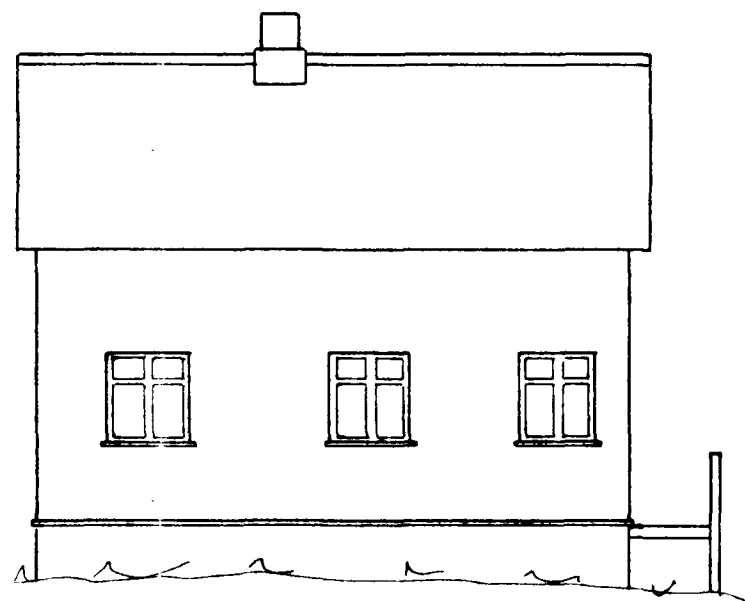

SUÐUR

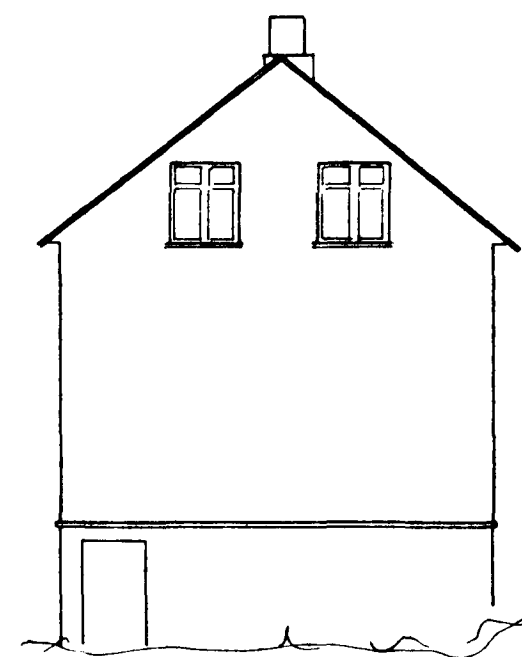

VESTUR

Samþykkt á fundi bygginga-  
nefndar d. 10.4.1985  
BYGGINGARFRÆÐINGUR  
I HAFNARFIRDI

*[Signature]*

*Balg. Sýmped.*

EFTIR BREYTINGU:

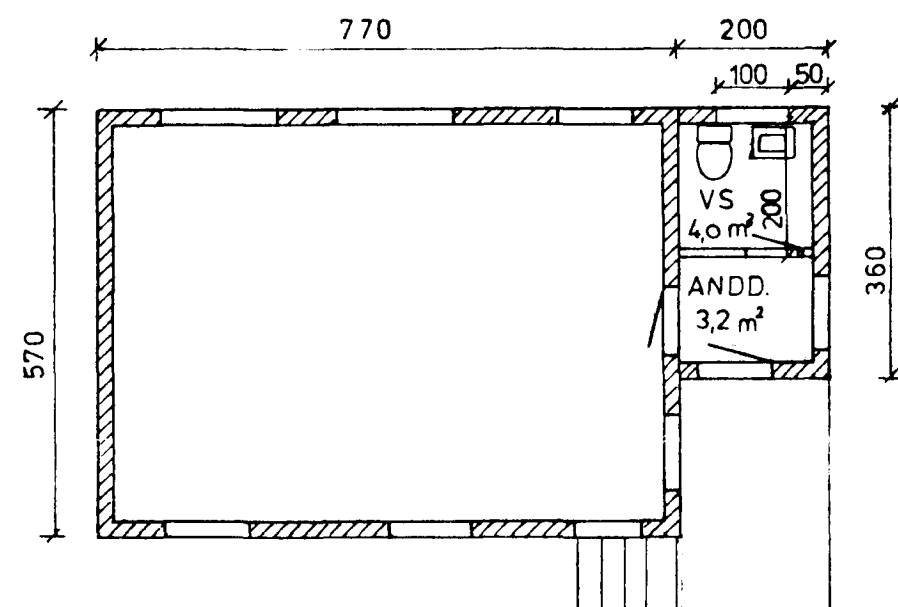
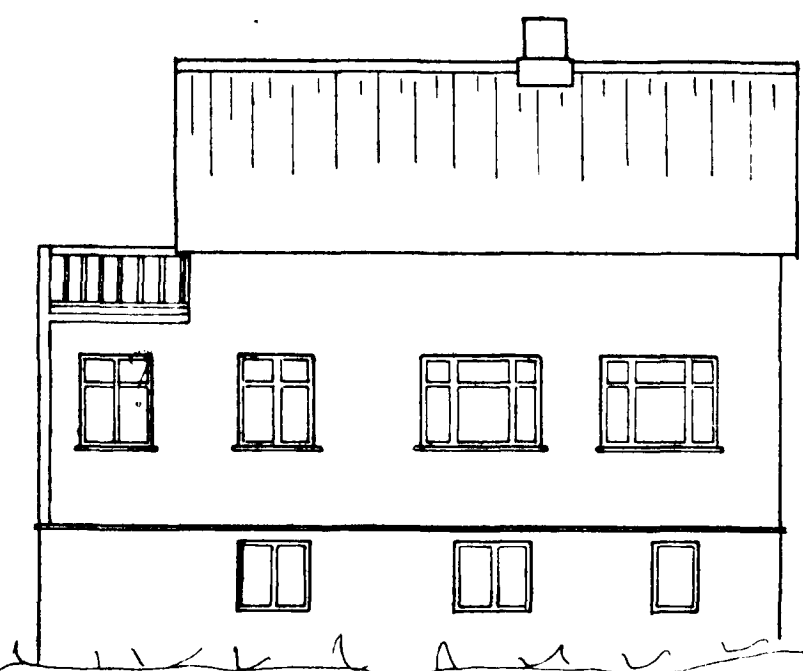
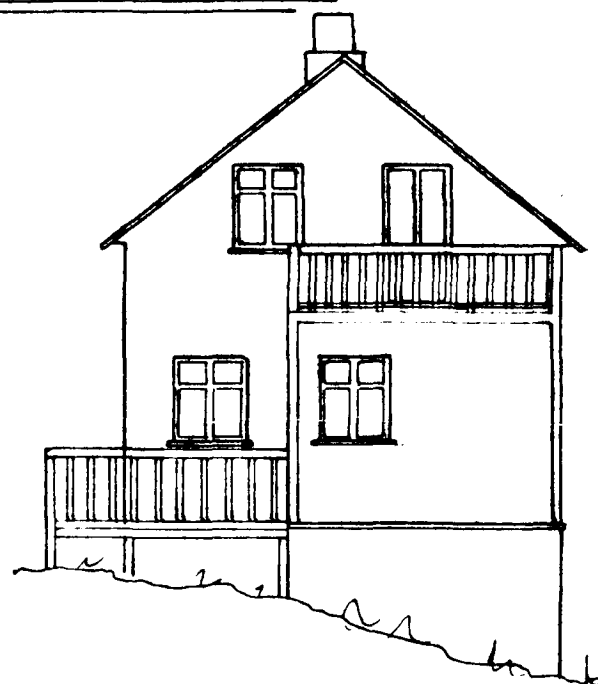

VIÐBYGGING:

FLATARMÁL 7,2 m<sup>2</sup>  
RUMMÁL 19 m<sup>3</sup>

B'ILGEYMSLA:

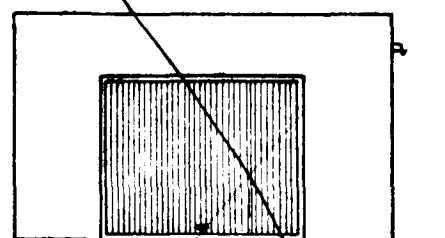

SUDUR

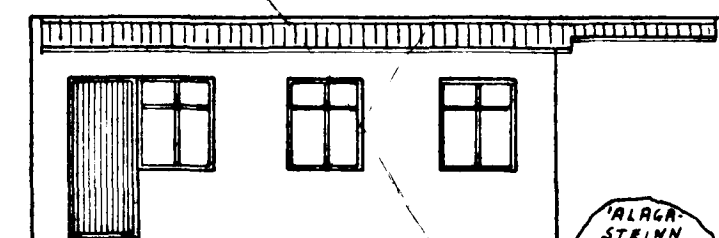

AUSTUR

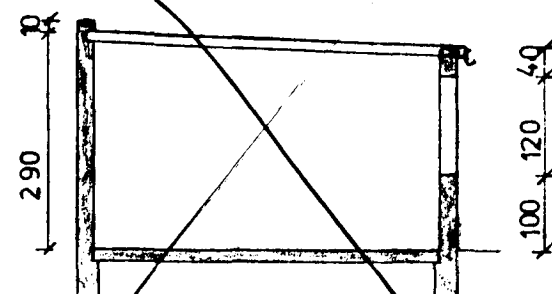

SNIÐ

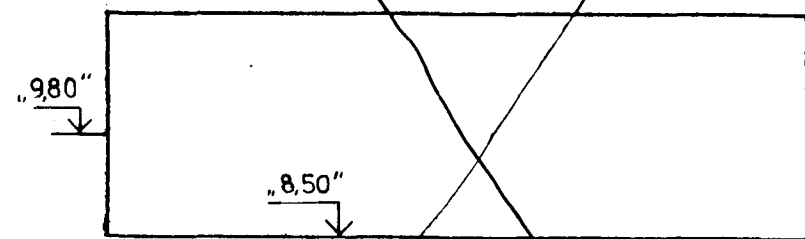

VESTUR

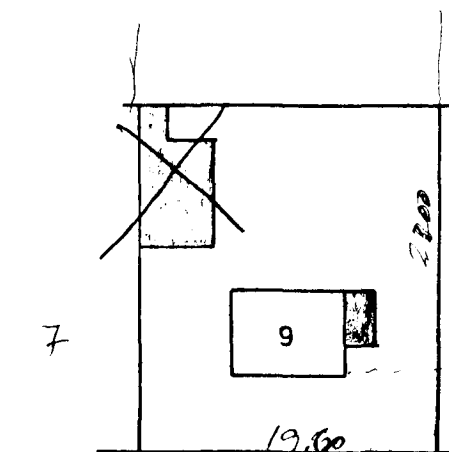
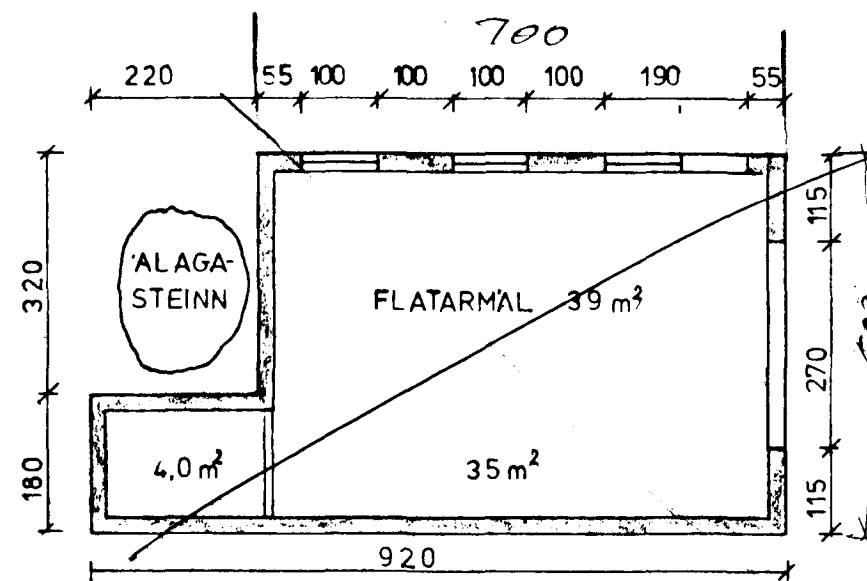
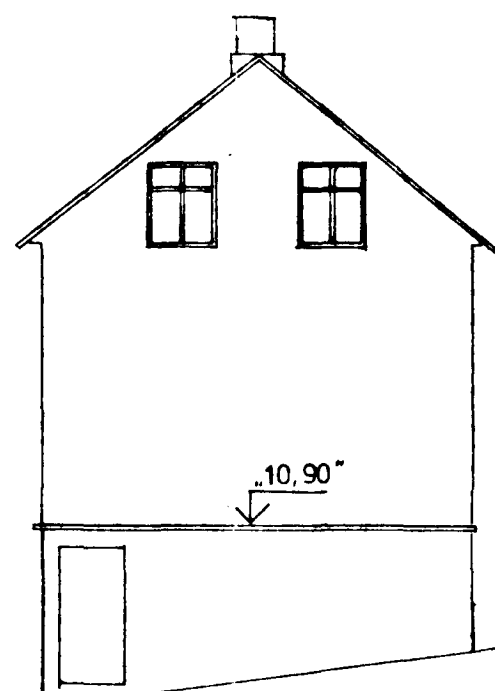

BRATTAKINN

AFSTAÐA 1:500

BRATTAKINN 9 HFJ.	Mælikv. 1:100	Verk	Teikn. nr.
VIÐBYGGING, B'ILGEYMSLA	Hannað: /	Yfirfarið: /	Dags. 9/4 1985
VERKFRÆÐIÞJÓNUSTA JÓHANNS G. BERGÞÓRSSONAR h/f.			
VERKFR. MVFI		HAFNARFIRDI - Símar 53315 OG 50241	