

VINKLAR 80+80 A HORNUM OFAN OG NEDAN

SNID - A 1:50

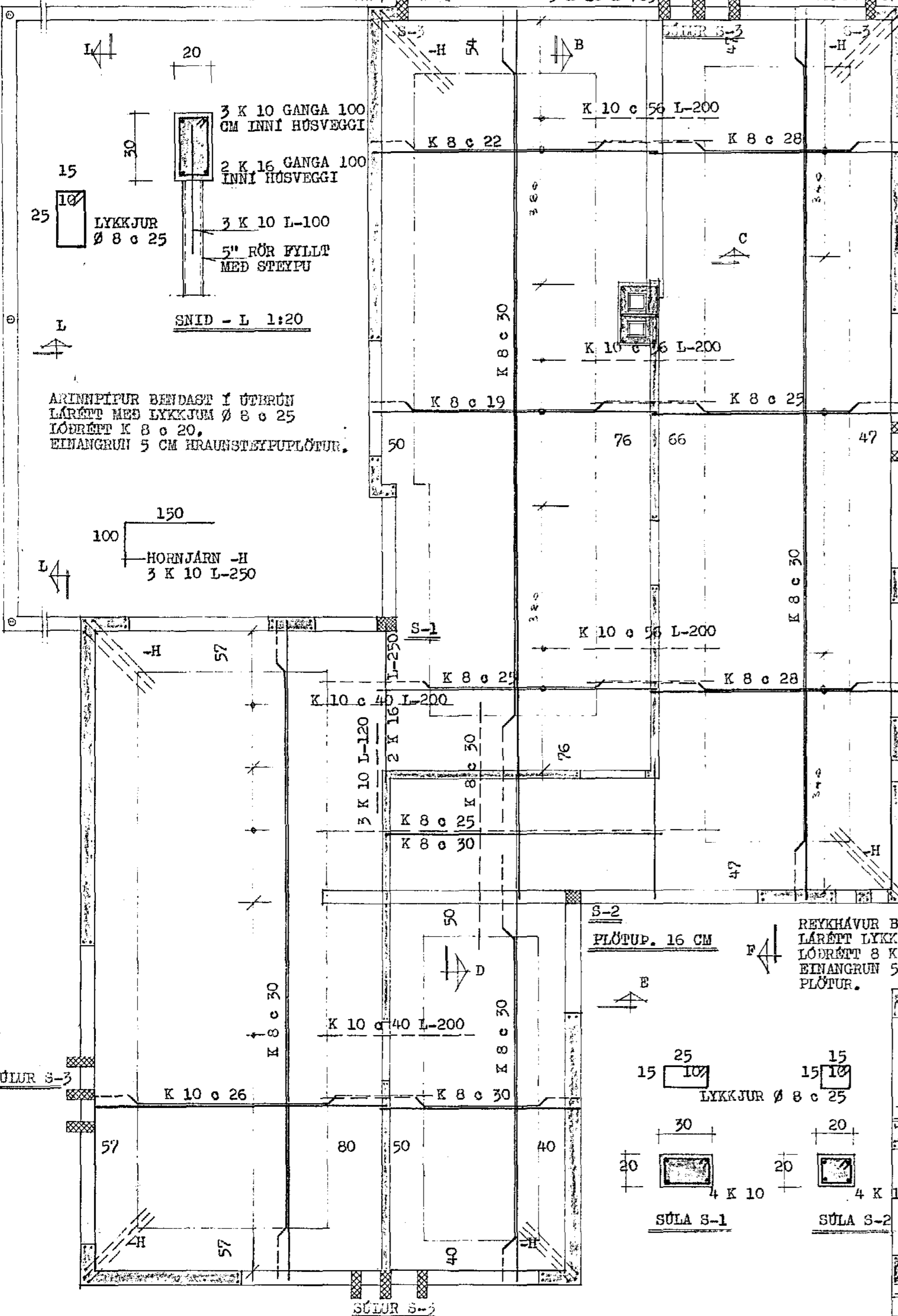

ARINNPIPUR BENDAST Í ÚTBRUN LÁRÉTT MEG LYKKJUR Ø 8 c 25 LÓDRÉTT K 8 c 20. EIMANGRUN 5 CM HRAUNSTEYPUPLÖTUR.

HORNJARN -H 3 K 10 L-250

REYKHAVUR BENDIST Í ÚTBRUN LÁRÉTT LYKKJUR Ø 8 c 25 LÓDRÉTT 8 K 8 EIMANGRUN 5 CM HRAUNSTEYPUPLÖTUR.

PLÖTUR. 16 CM

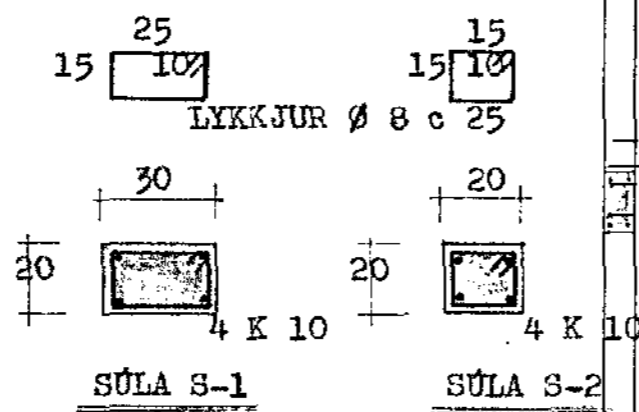

ARVEGGUM BEYGT FYRIR HORN SJA SNID 4F
TENGIJARN K 10 c 30

SNID - B 1:20

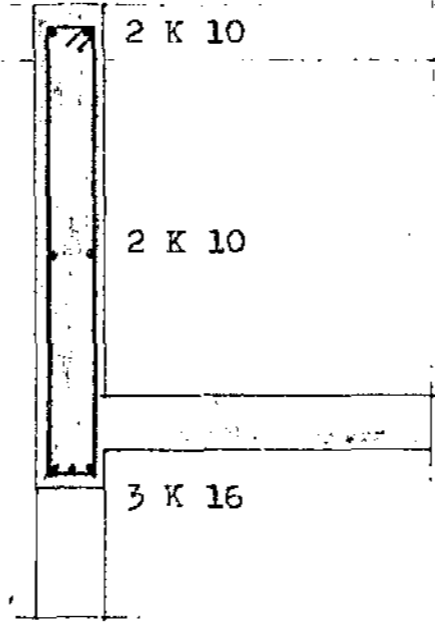

LYKKJUR Ø 8 c 25 L-156 17 STK

SNID - C 1:20

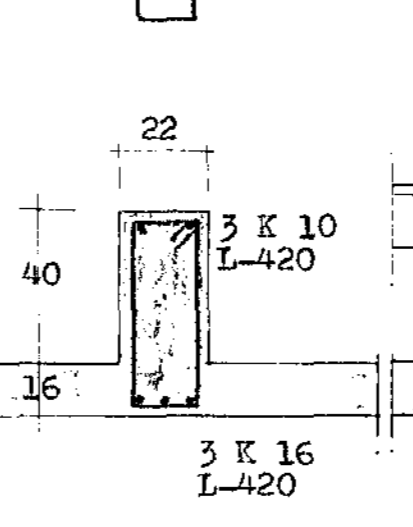

SNID - D 1:20

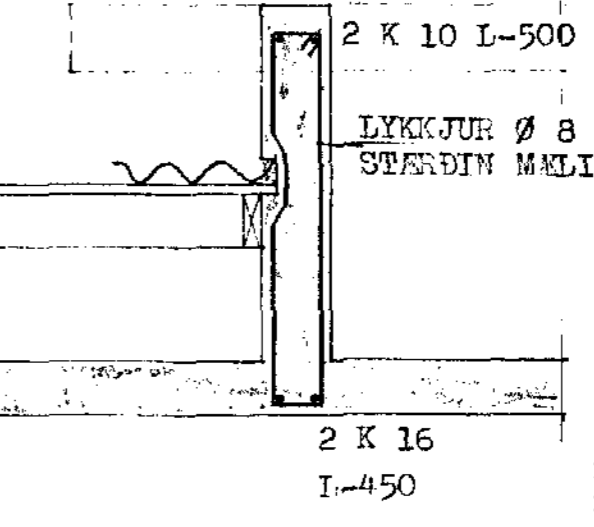

SNID - E 1:20

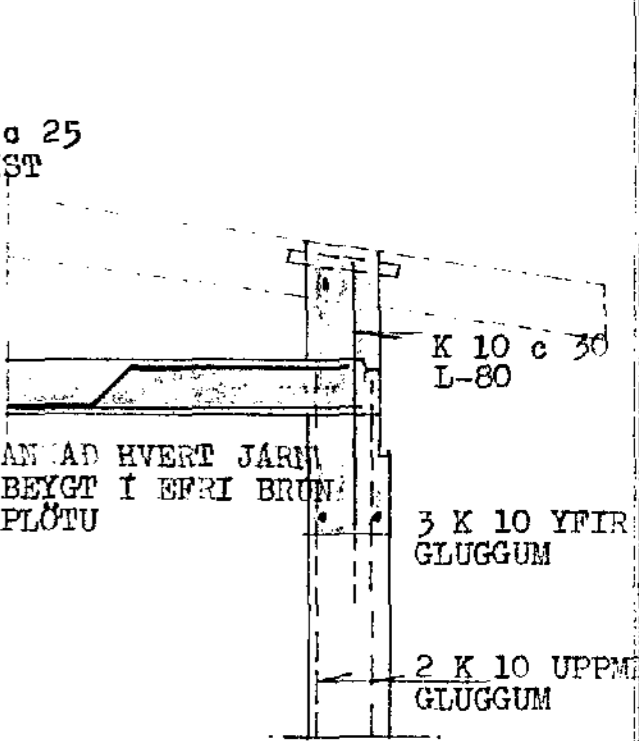

LOFTUN A PAKI 1/2" PLASTRÖR BIL SAMKV. BYGGINGA-SAMP.

SNID - F 1:20

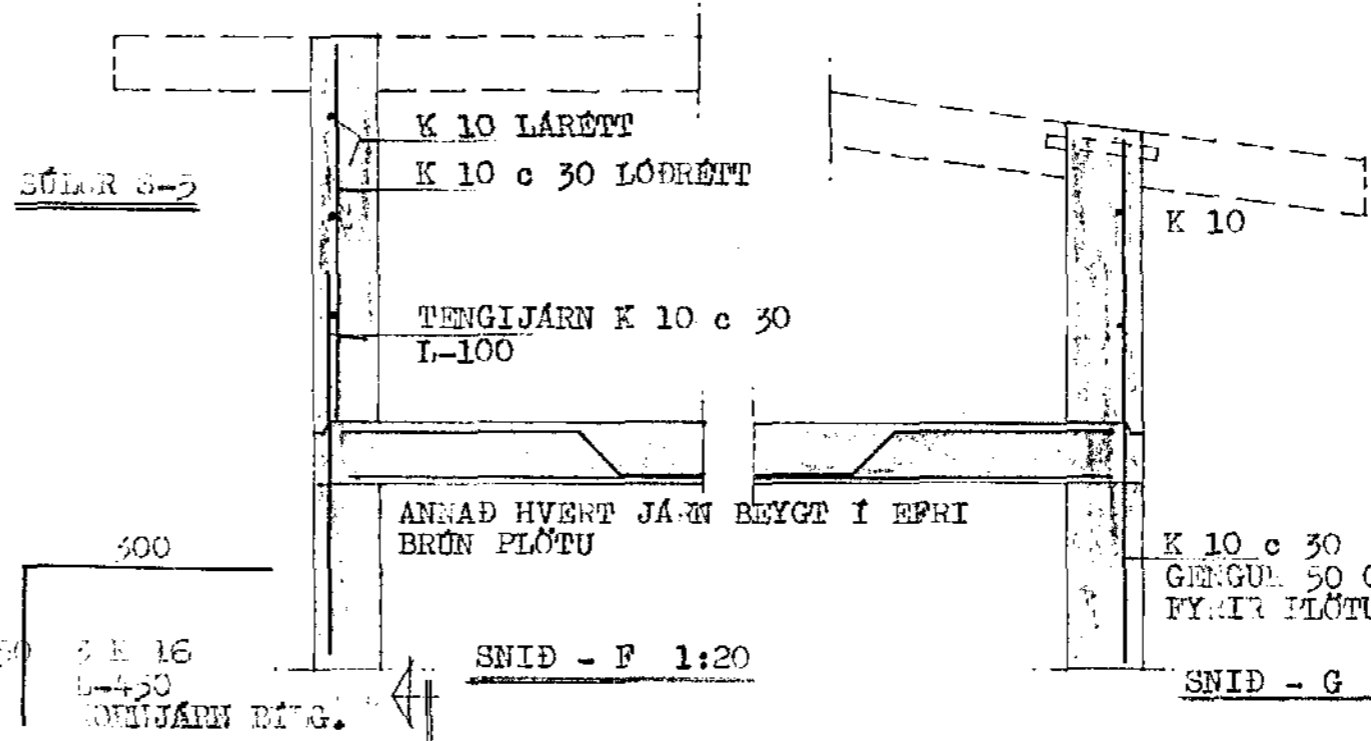

SNID - G 1:20

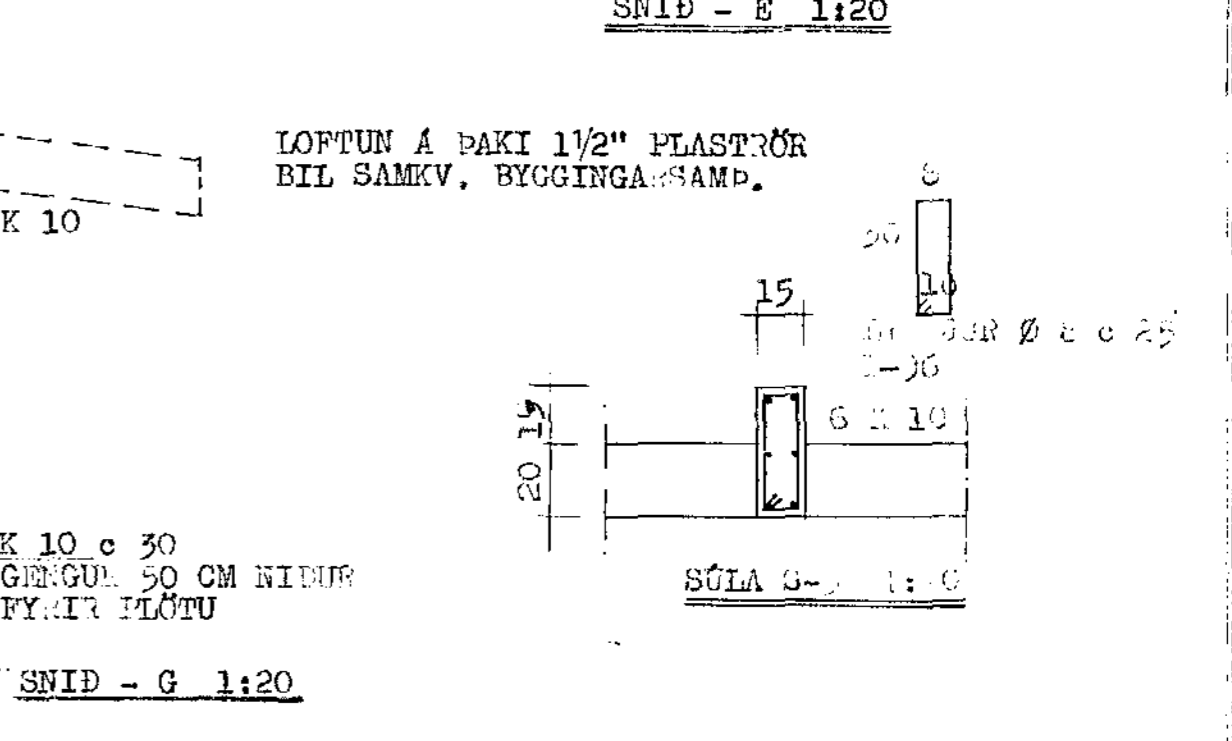

SNID - H 1:20

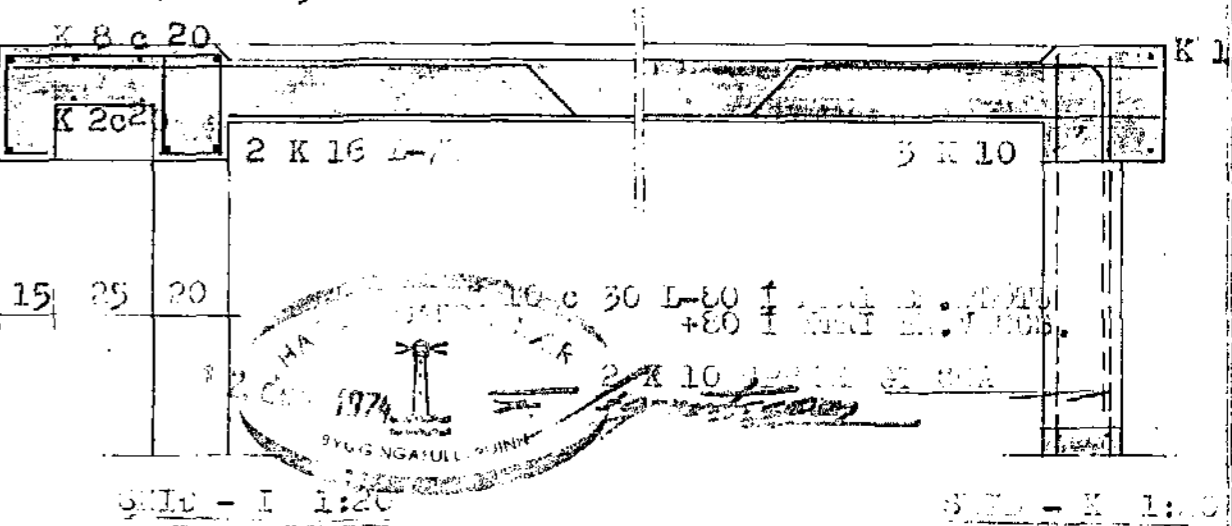

SKÝRINGAR:

STEYPUGARNI S-160 (MINNST 300 KG SEMENT Í M³ STEYPU)
STEYPUSTYKTA-STÁL KS 40 MERKT -K
ST 37 MERKT -Ø
UNDIR OG UPPMÆD GLUGGUM KOMA 2 K 10, EINS Í VEGGENDA
OG UPPMÆD DYRUM. YFIR DYR OG GLUGGA KOMA 3 K 10,
NEMA ANNAÐS SÉ GEFID. JARN ÞESSI GANGA MINNST 70 CM
ÚT FURIR OPIN, SÞA HEIL YFIR FLEIRI OP.

STEINGRIMUR TH. ÞORLEIFSSON MFFI		
JÓN VASGUR MR.S, HAERARFERNI		
MÁL	1:50	JARNBENT STEINSTEYPA LOFTPLATA HEDAR OG BILSKÖR
DAGS.	1974	
BLAD	5	