

UNDIRSTÖÐUR GRUNNMYND 1:50

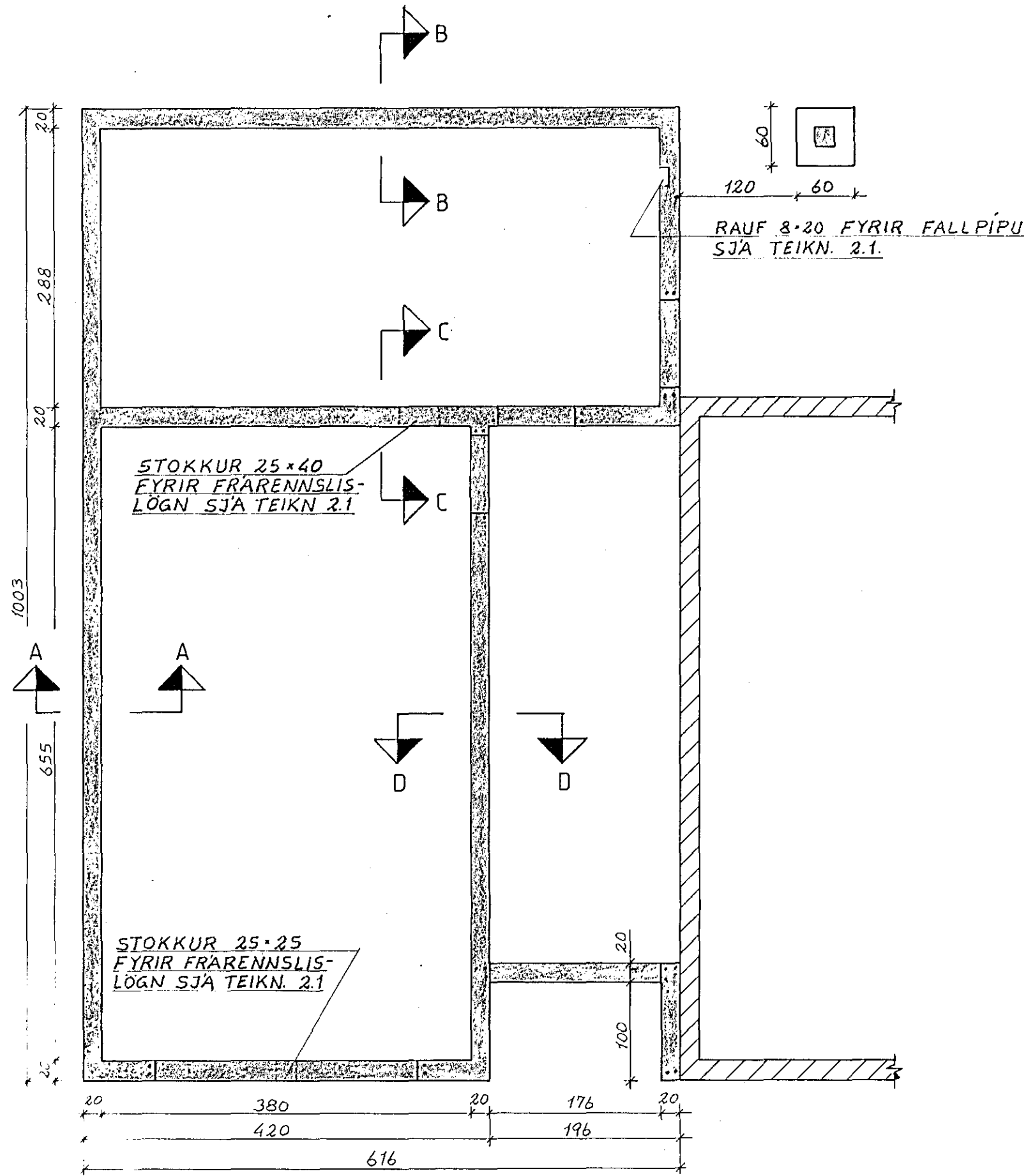

SNID A-A 1:20

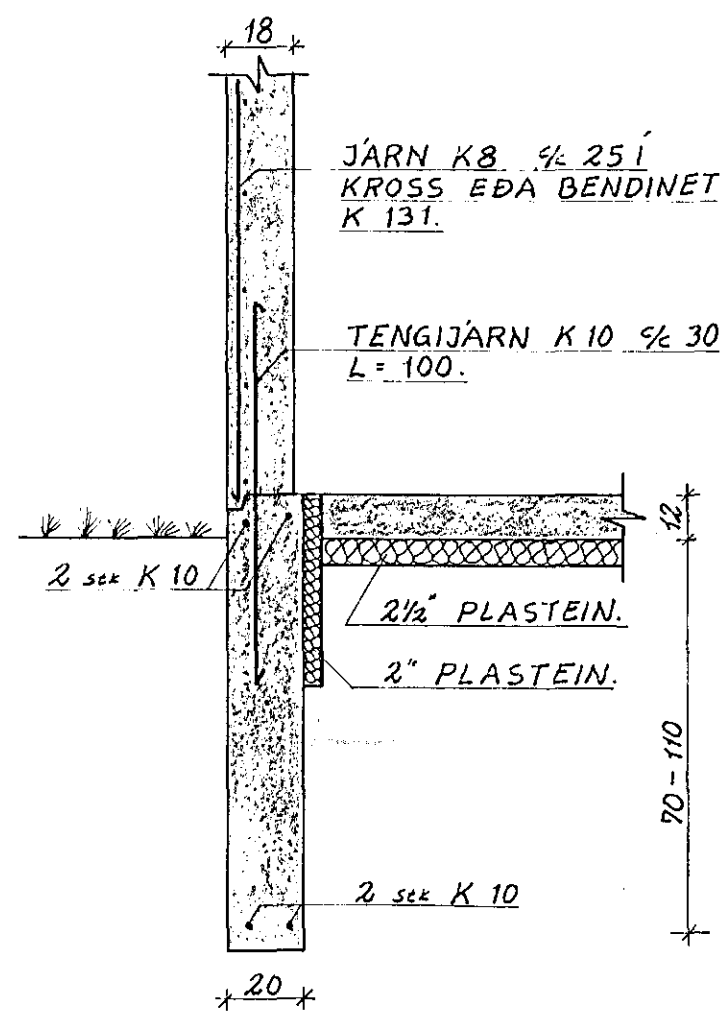

SNID B-B 1:20

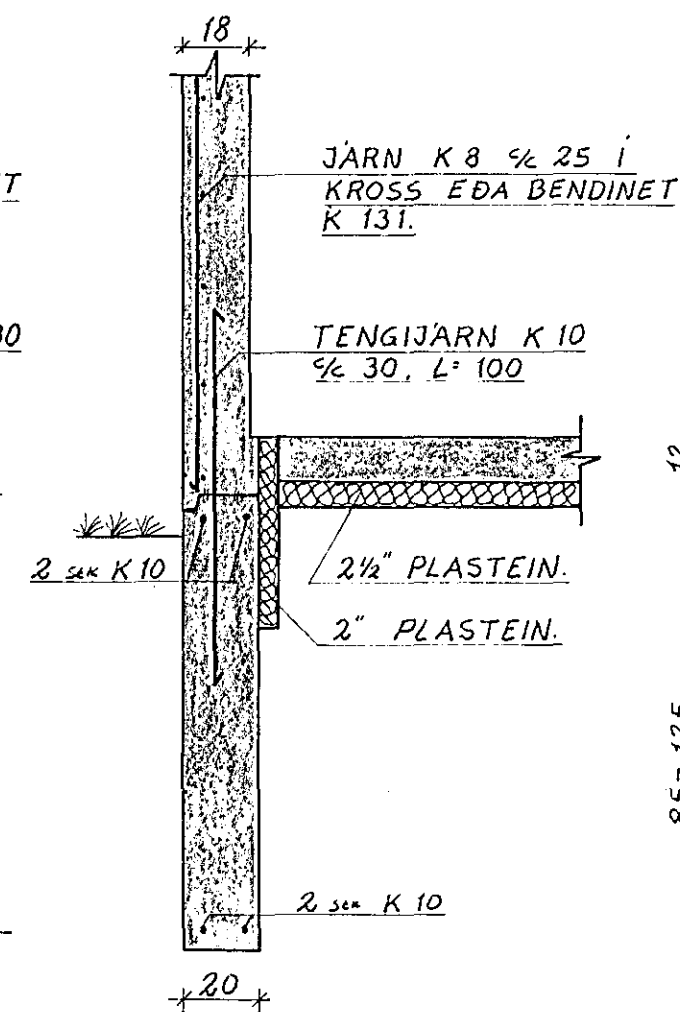

SNID C-C 1:20

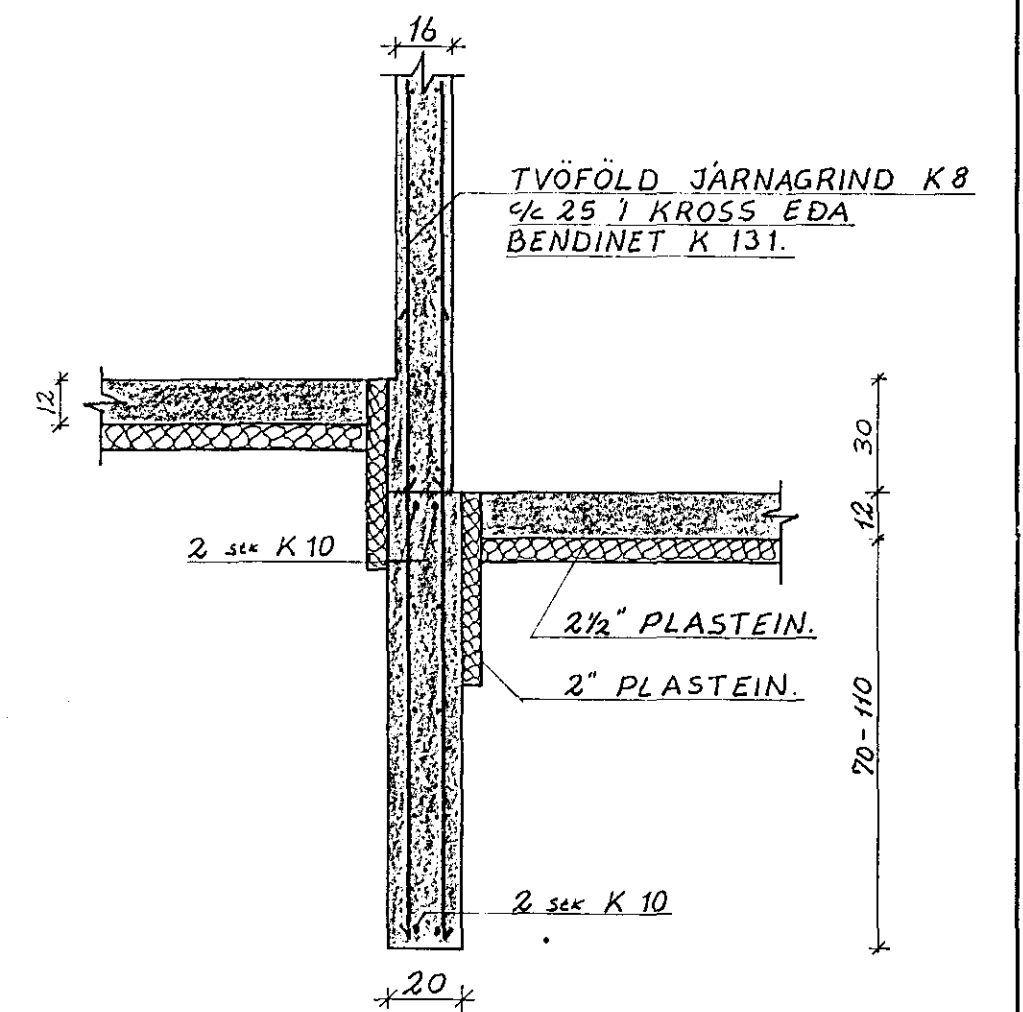

SNID D-D 1:20

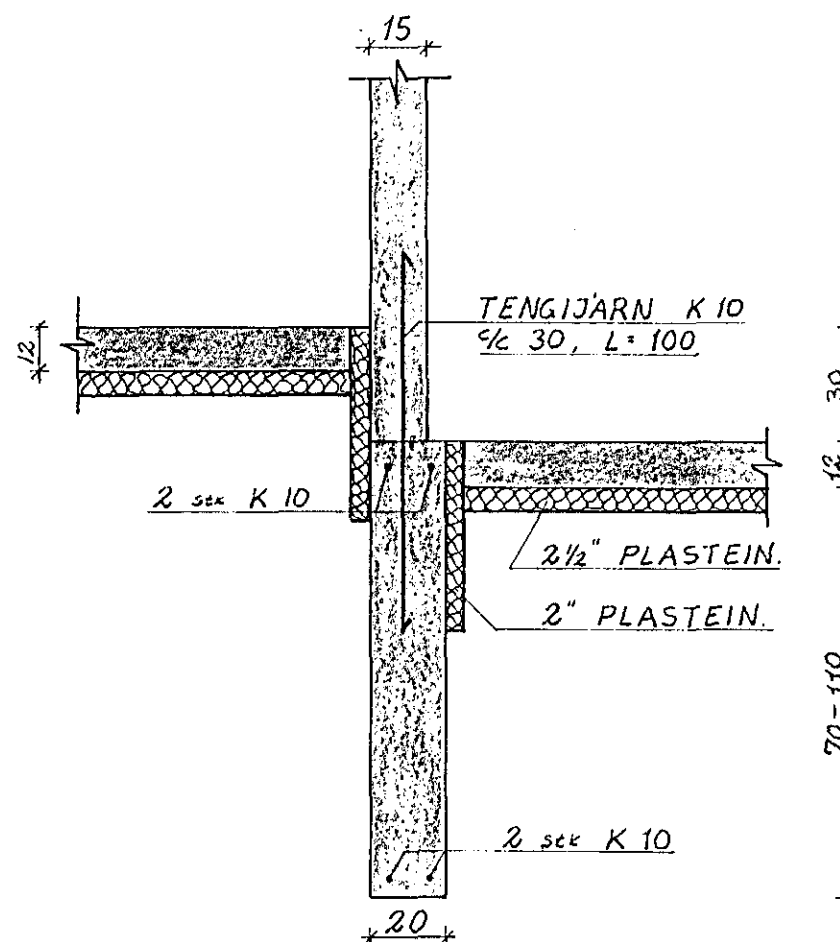

SÚLA 1:20

GRUNNMYND

SNID

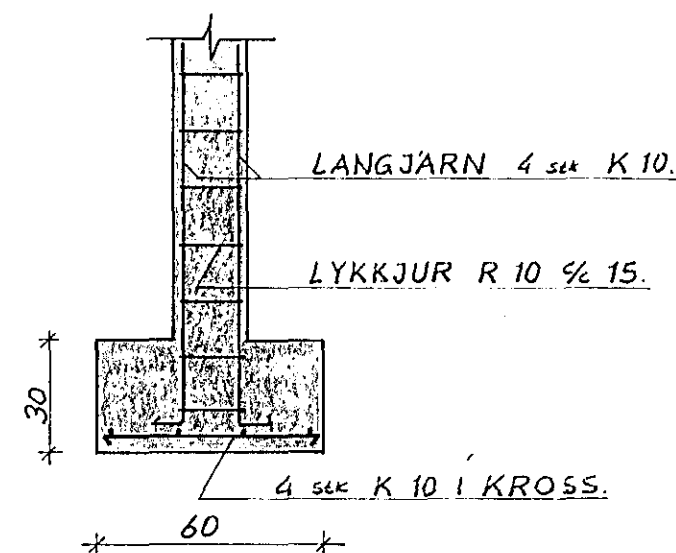
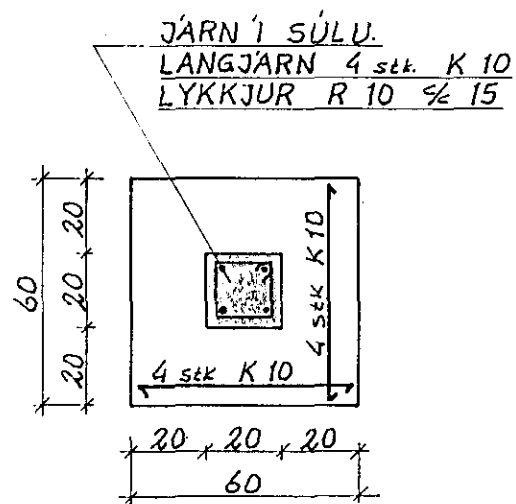

SKÝRINGAR:

STEYPA S 200, KAMBSTÁL (K) Ks 40, SLÉTT STÁL (R) sl. 37, SKEYTILENGD 40 * φ. FYLLT UNDIR PLOTU MÆÐ GRÚS, SEM ÞJAPPAST VEL. ÖNEFND MÁL ERU cm.

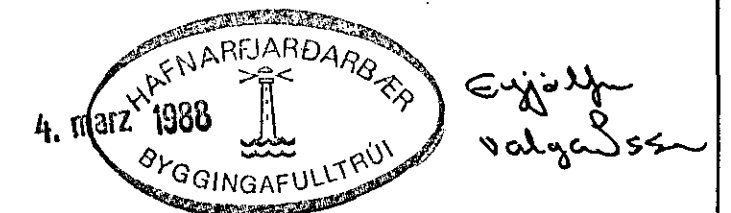

VERKFRÆÐISTOFA HALLDÓRS HANNESSONAR S. 91-54355 SUDURGÖTU 14-220 HAFNARFJÖRDUR

HLÍÐARBRAUT 1 HAFNARFIRÐI
UNDIRSTÖÐUR, GRUNNMYND OG SNID.
VIÐBYGGING.

Mkv: 1:50, 1:20
Reiknað: *Súður B.*
Teiknað: *Súður B.*
Yfirfarið: *ABP*