

SÆRM. 1

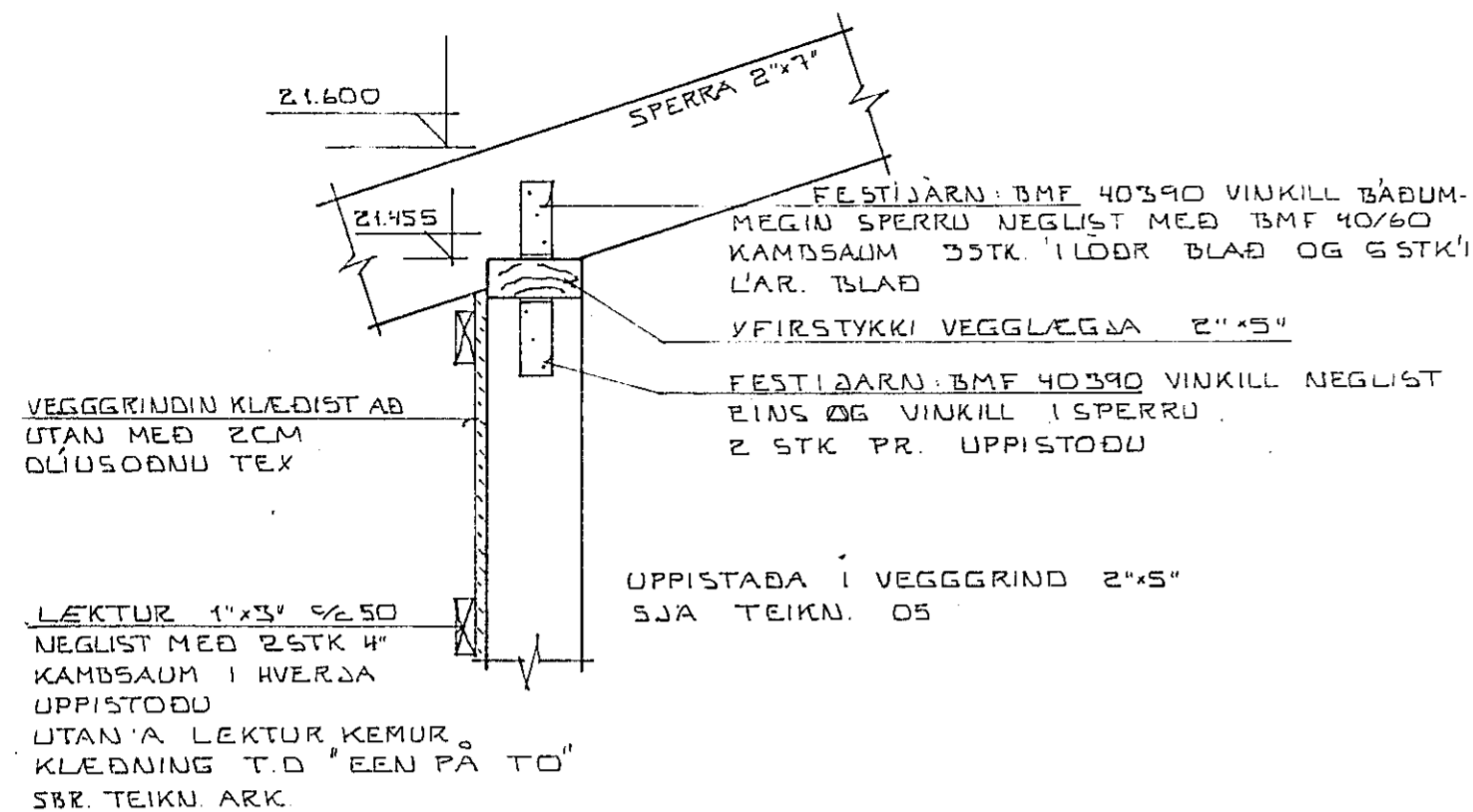

SÆRM. 2

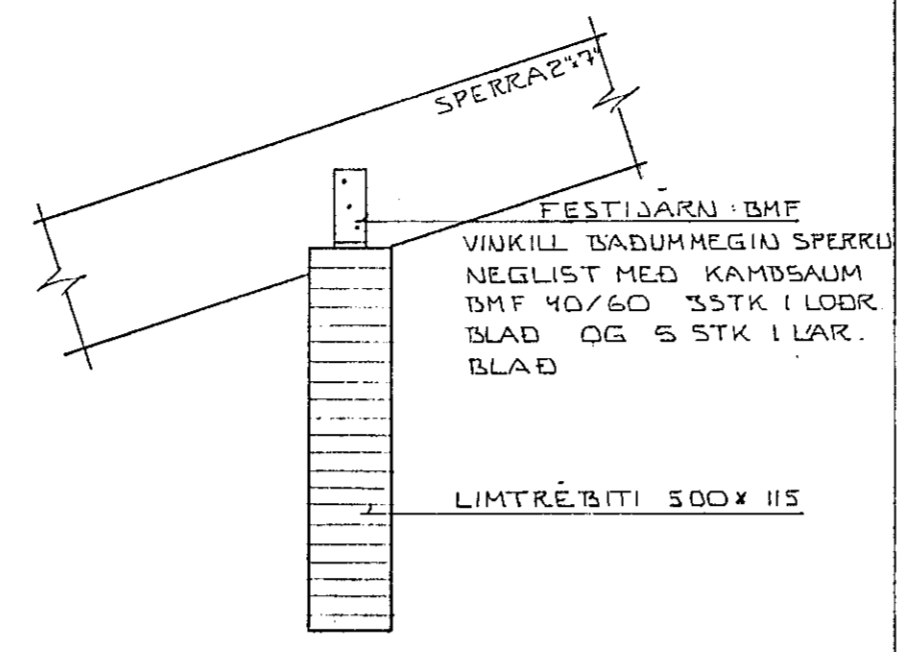

SÆRM. 3

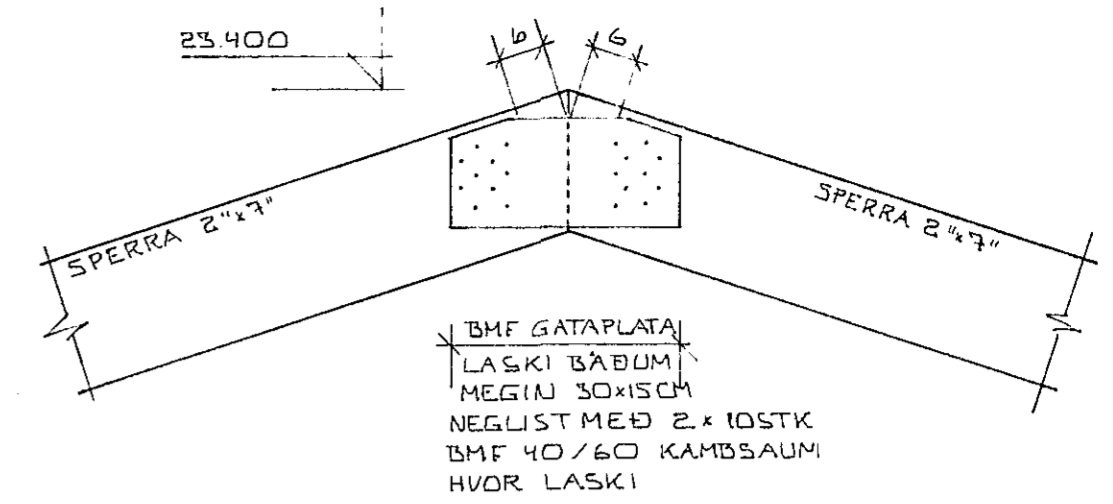

SÆRM. 4

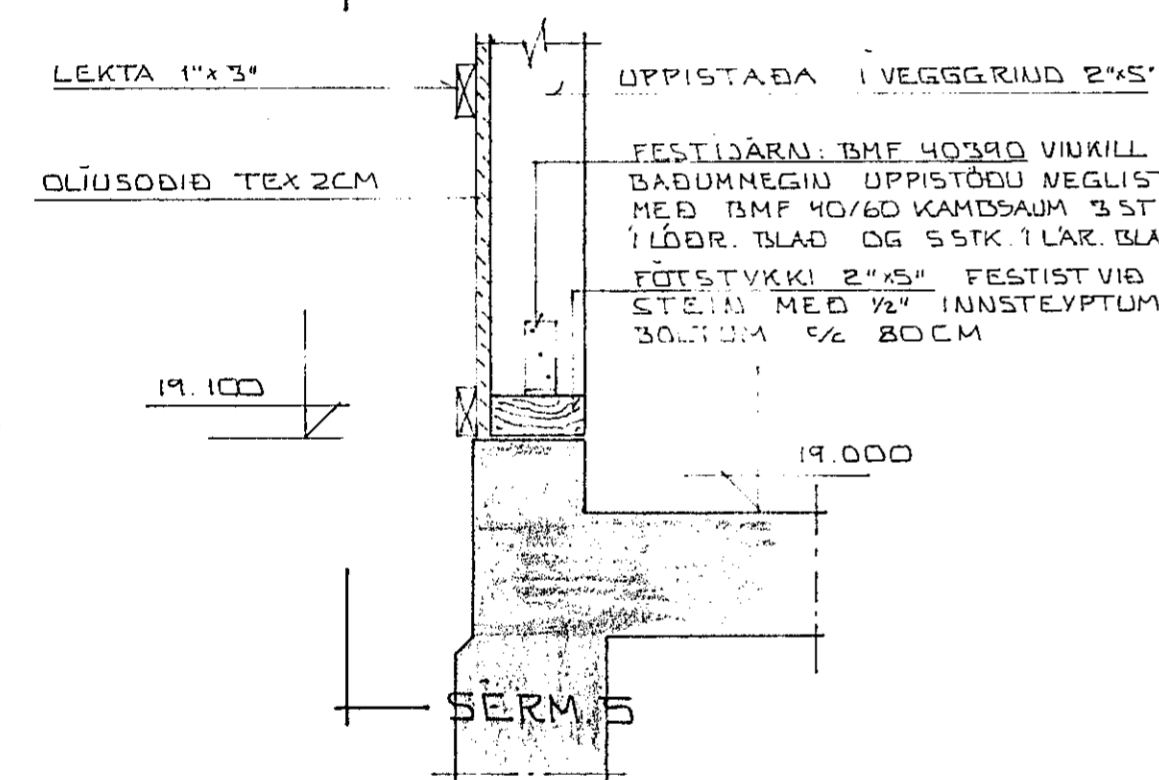

SÆRM. 5

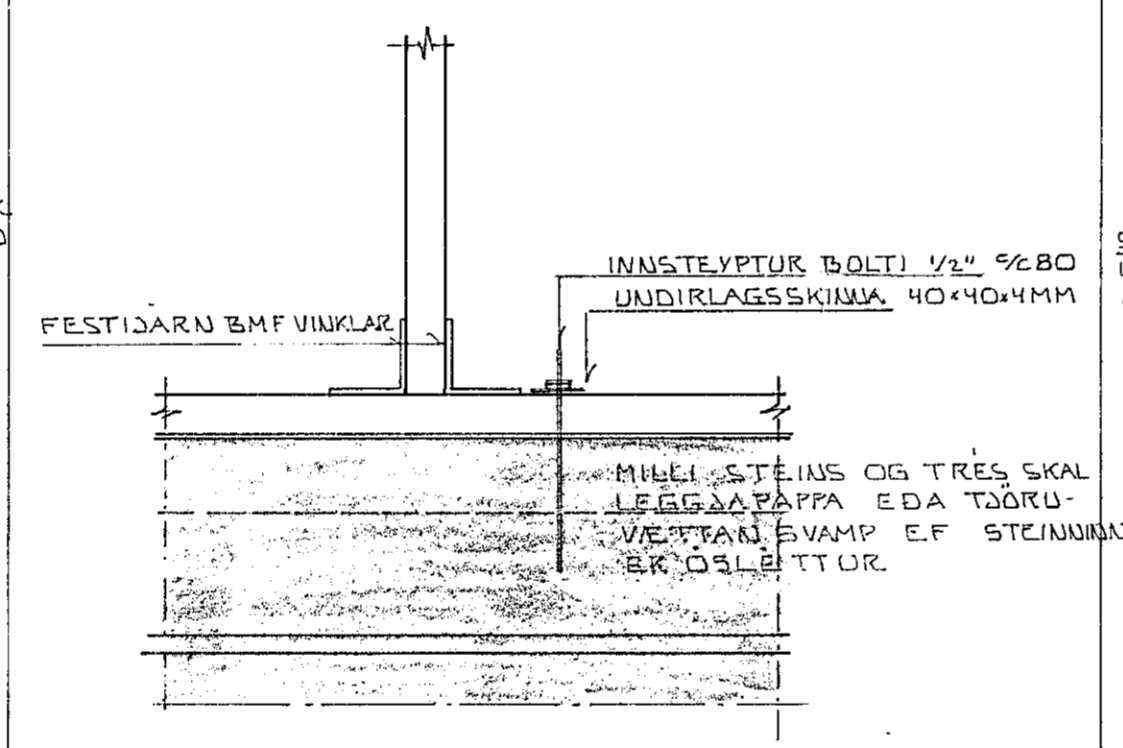

SÆRM. 6

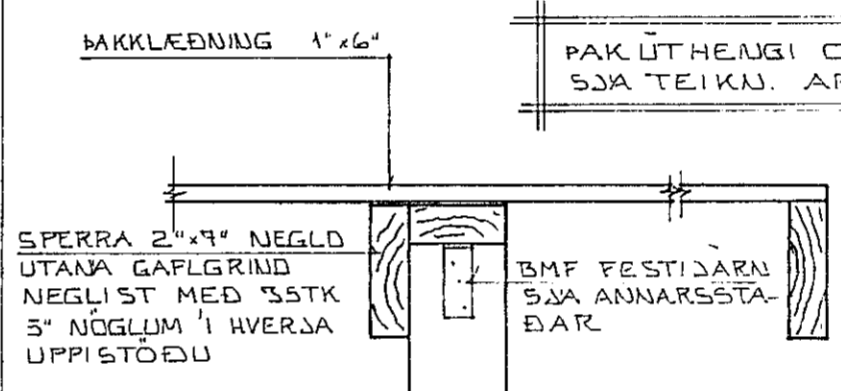

SÆRM. 7

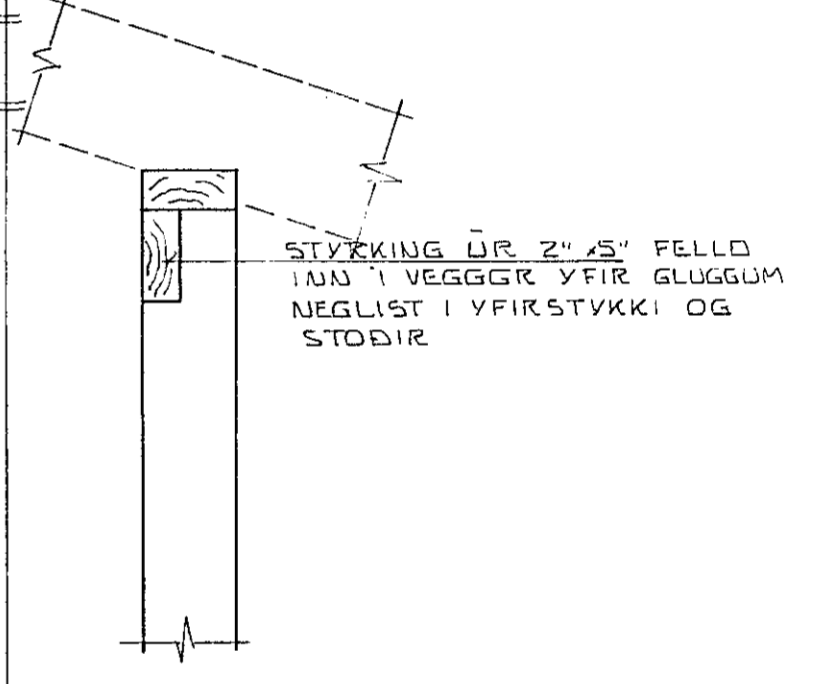

29. jan. 1982

SÆRM. 8

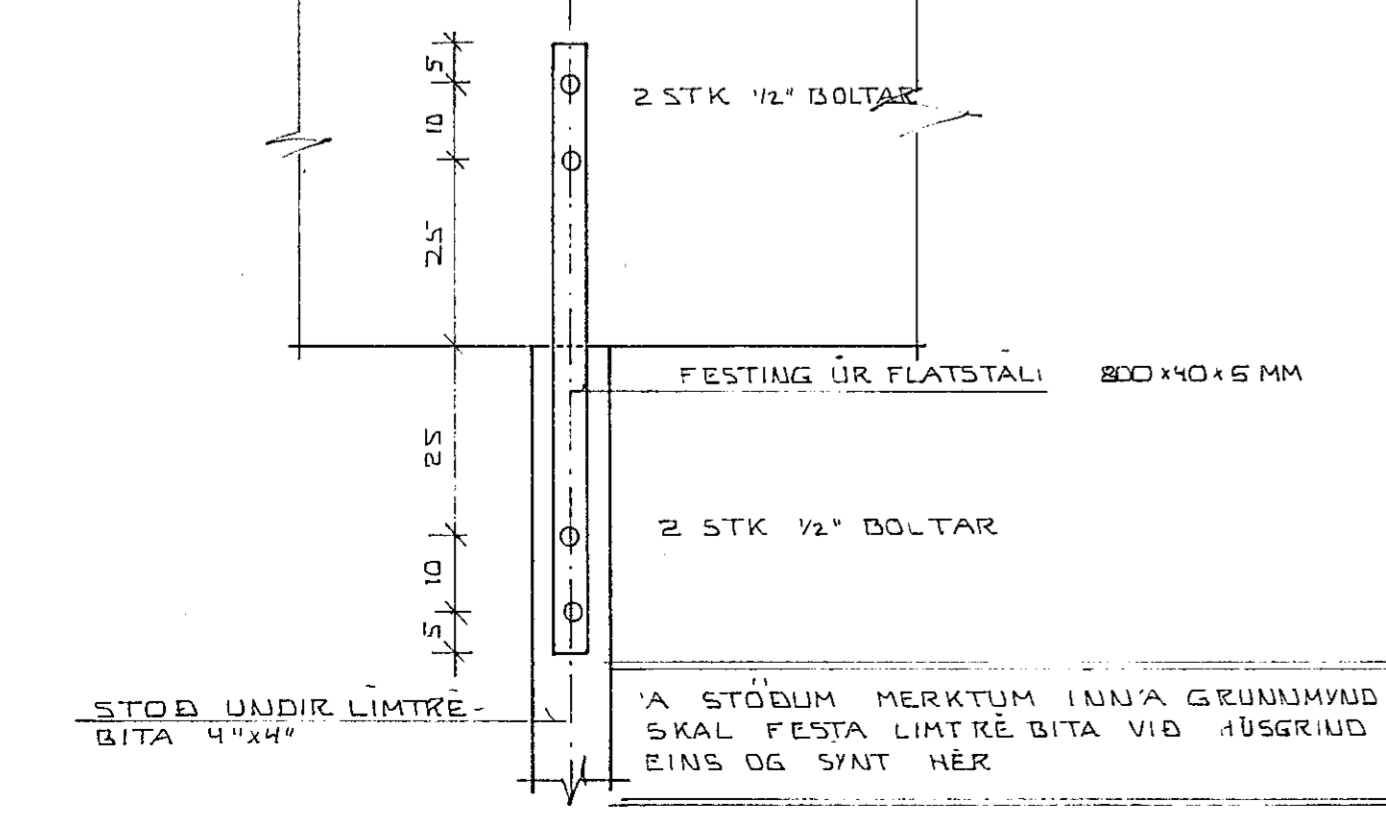

SÆRM. 9

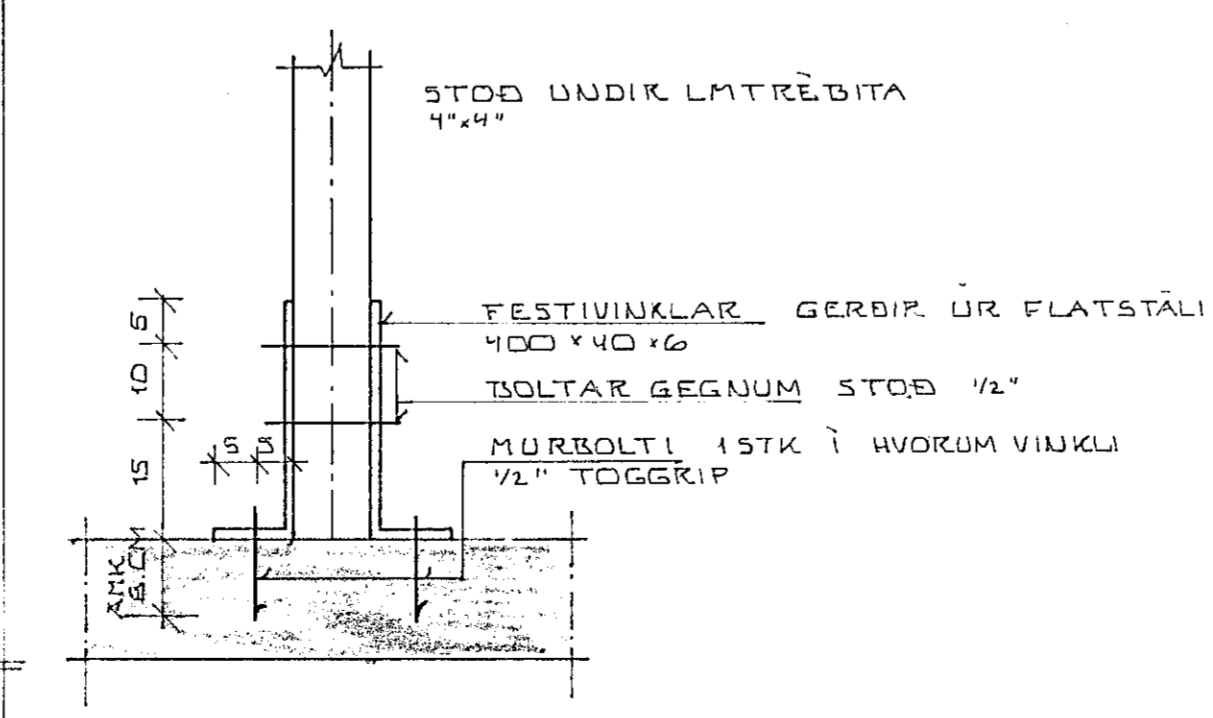

SKÝRINGAR

ALLT TIMBUR Í VEGGGRIND OG ÞAKI SKAL VERA GALLALAUST OG AÐ VANKANTA
 TIMBUR SEM LIGGUR AÐ STEINI SKAL FÚAVARÍÐ MEÐ ÞVI AÐ BERA Á ÞAÐ TVER UMFERÐIR AF LITLAUSU FÚAVARNAREFNI
 FESTIDJARN SEU AF GERÐ BMF (ÞÁLL ÞORGEIRSSON) EÐA SAMBERIL ALLUR SAUMUR SEM NOTAST VIÐ GRIND EÐA Í ÞAKI GÆ GALVANHÚÐAÐUR
 ÖNNUR FESTIDJARN OG BOLTAR SEU ANNAÐHVORT GALVANHÚÐAÐ EÐA Í ANNAÐ HATT TRYGGILEGA RYÐVARÍÐ
 LIMTRE BÉ SKV. SKANDINAVISKUM STÖBLUM (L) MERKT

HRAUNBRÚN 46 HAFNARFIRÐI SNID OG SÆRM. Í VEGGGR. OG ÞAKI	DAGS. 820119
MELIKV 1:10	REIKN. <i>Sigurður</i>
SIGURÐUR ÞORLEIFSSON, TEKNIFRÆÐINGUR F.T.F.Í	TEIKN. <i>Sigurður</i>
STRANDGÖTU 11 HAFNARFIRÐI SÍMI 54761	VERK.NR. 8140
	TEIKN.NR. 06