

SNID B-B 1:50

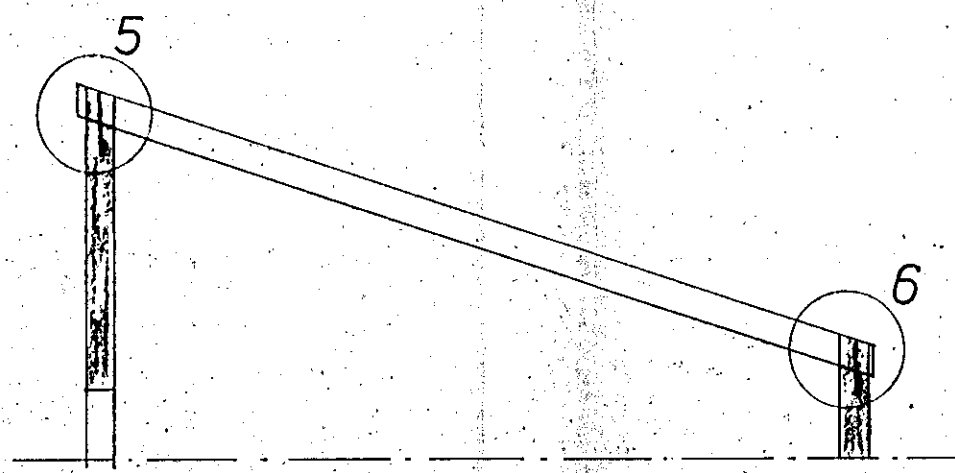

SNID C-C 1:50

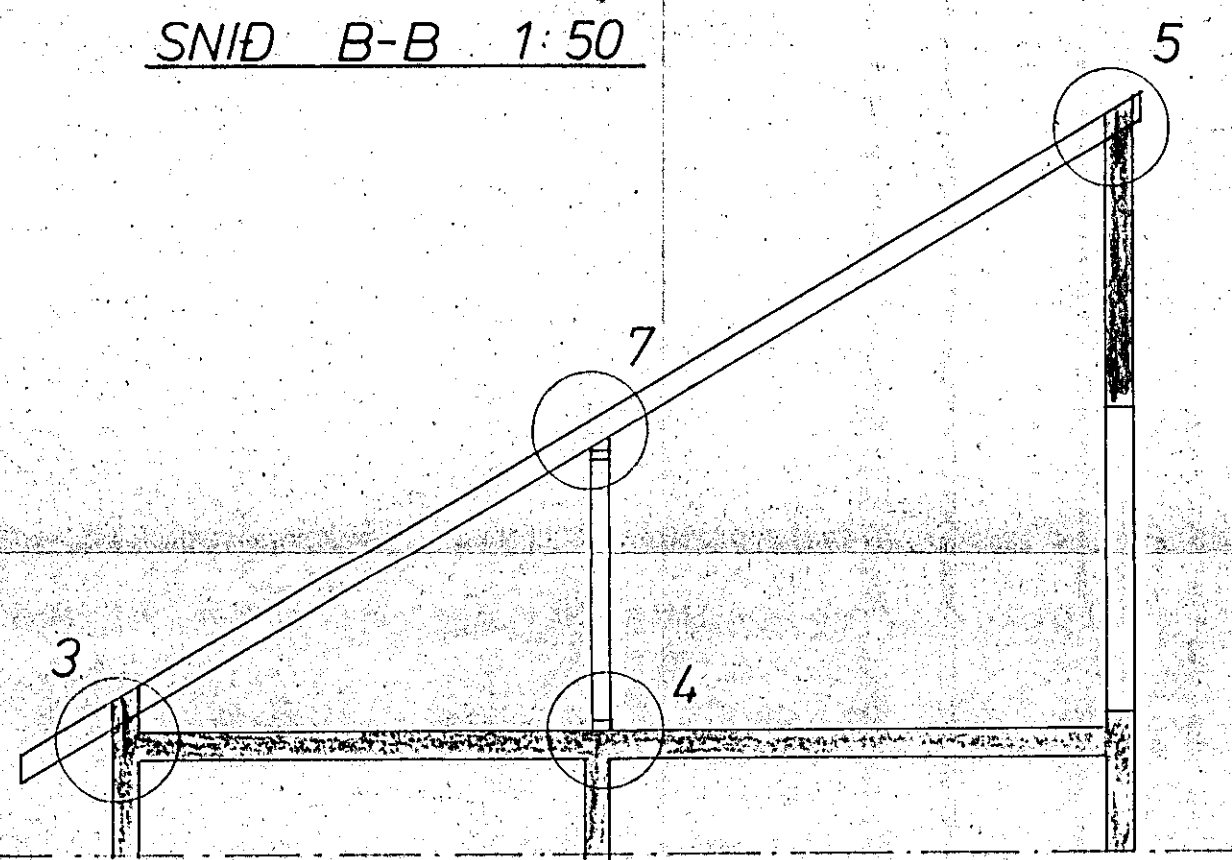

SNID A-A 1:50

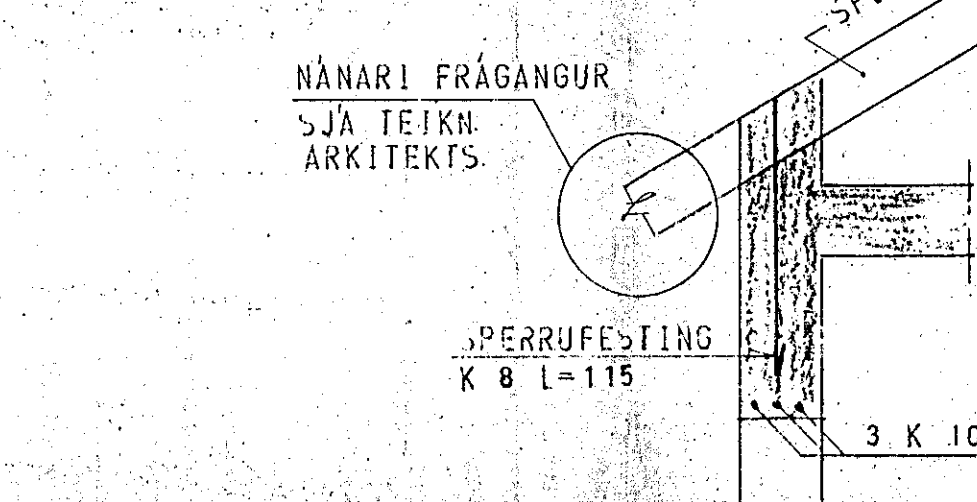

SERMYND 3

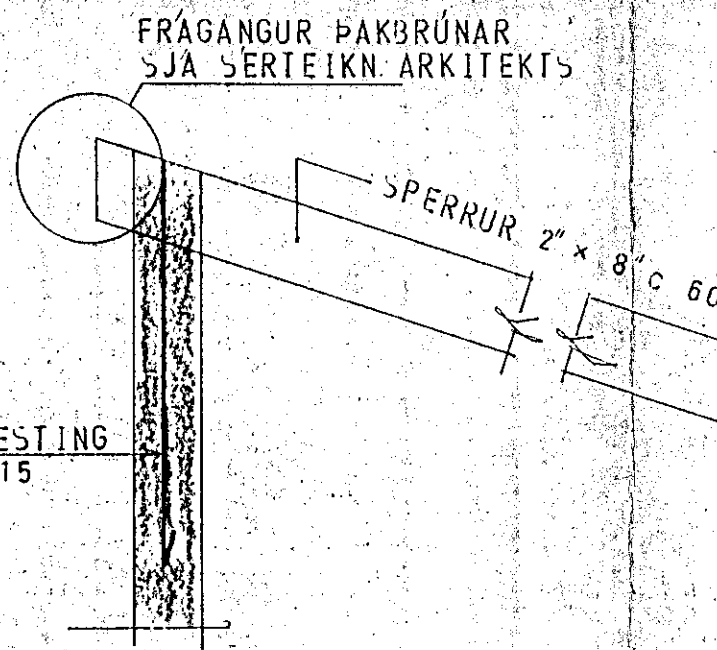

SERMYND 5

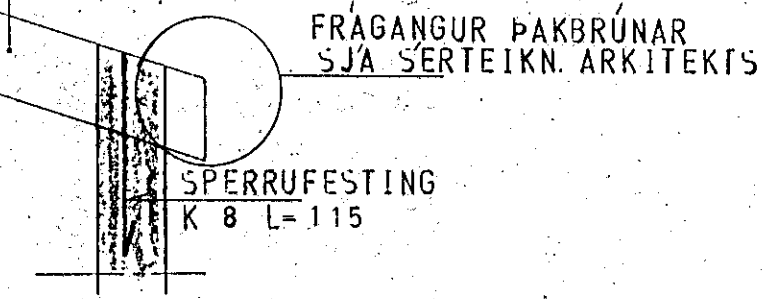

SERMYND 6

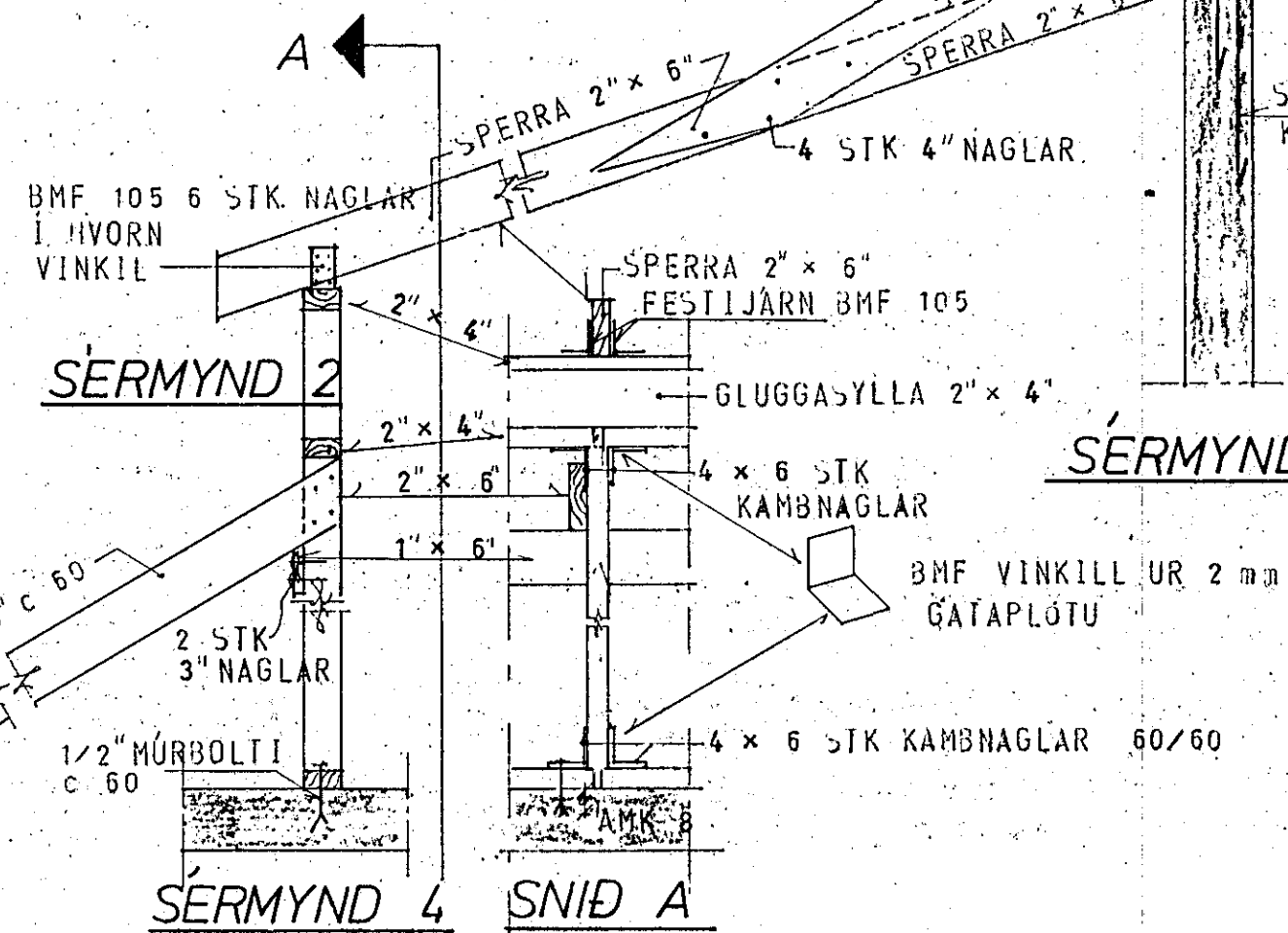

SERMYND 2

SERMYND 4

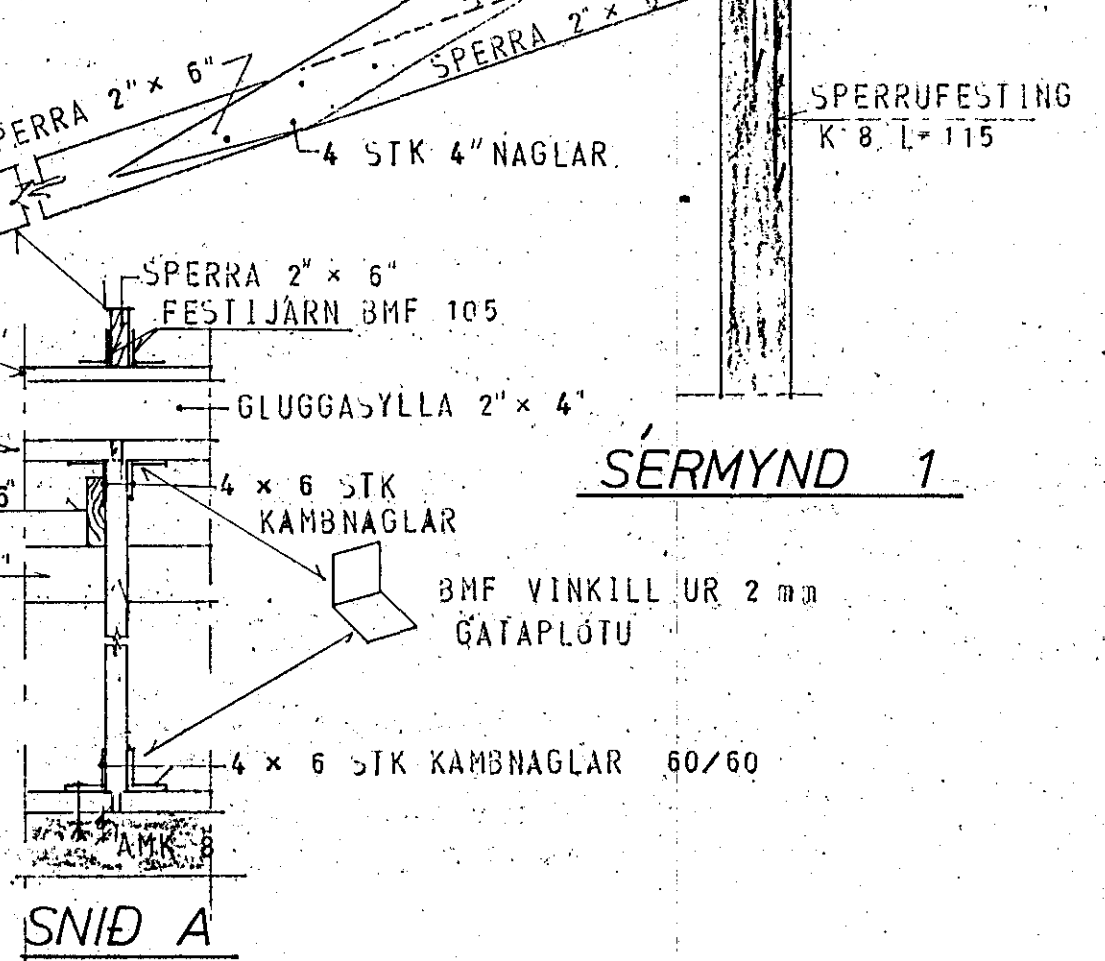

SERMYND 1

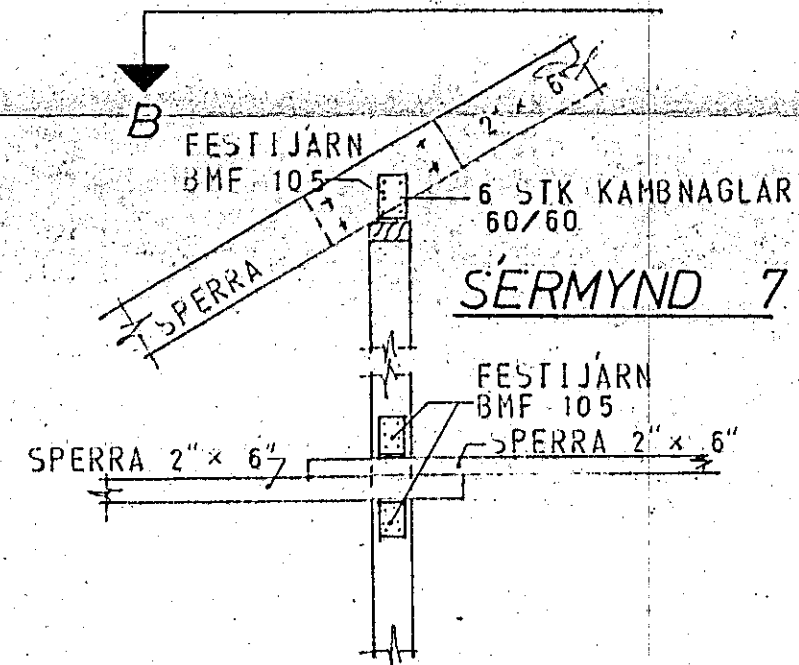

SERMYND 7

SNID B 1:20



SKÝRINGAR SJA TEIKN. NR. 1.0

HÚS E

KLAUSTURHVAMMUR 16	MÆLIKVARDI 1:50	VERK 800 I	TEIKN NR. 15.
SNID OG SERMYNDIR I ÞAK	Hannað Teiknað: 3.7.	Yfirfarð Samb: 1.1.	DAGS MAÍ '80
JÓHANN GUNNAR BERGPÓRSSON STRANDGÖTU 11 — HAFNARFIRÐI — SÍMÍ 53315	VERKFR MVFI	BREYTT	