

GRUNNMYND 1:50

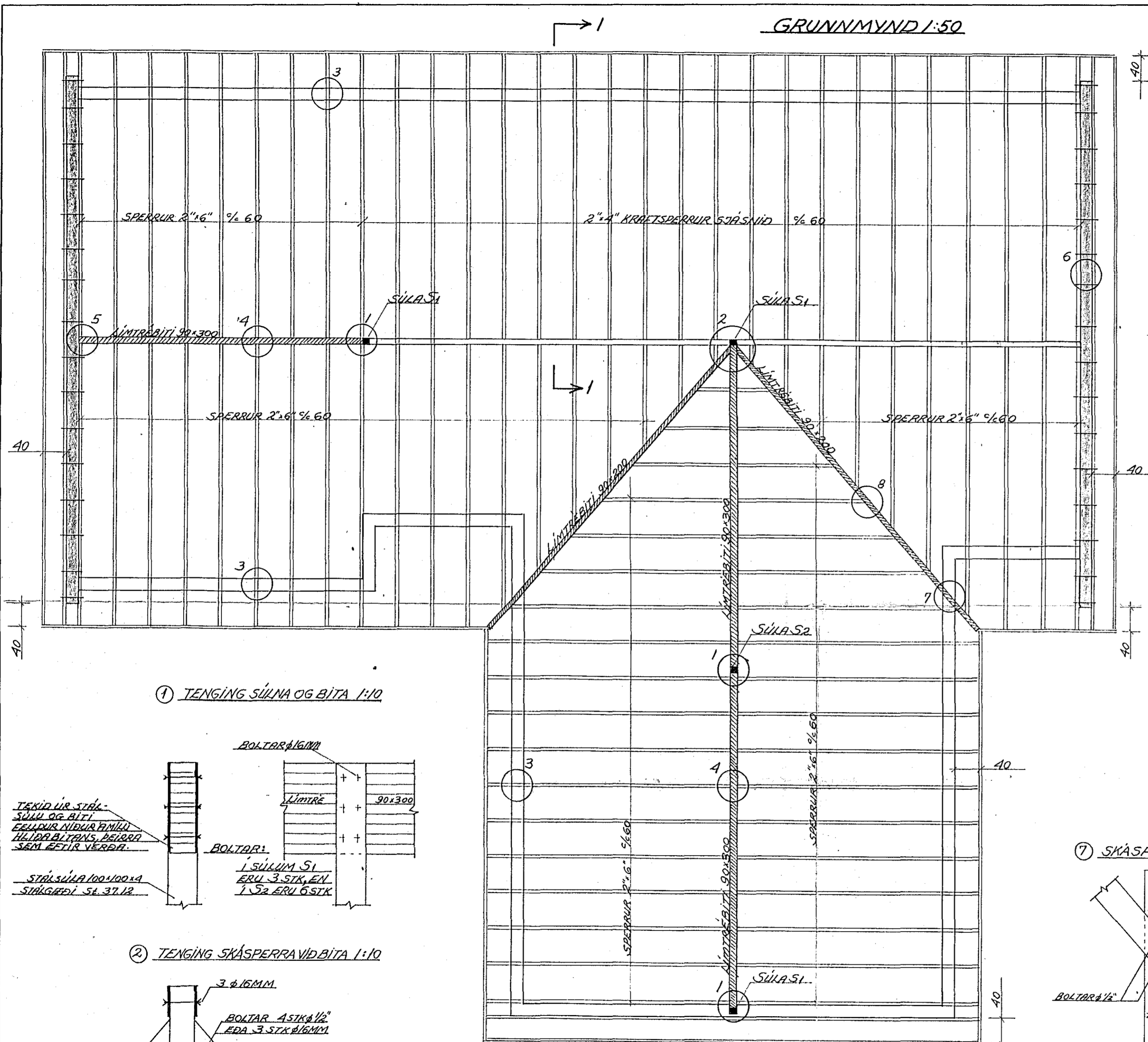

SNID 1-1 1:50

ÖLL TRÉ Í KRAFTSPERRUM 2"x4"
NEGLINGAR Á SAMSKYPTUM ERU
4 STK 4" NAGLAR.

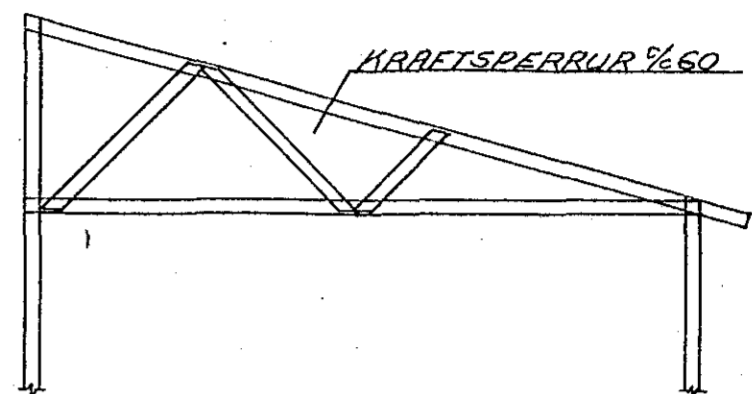

5 LÍMTRÉ/STEYPTUR VEGGUR 1:10

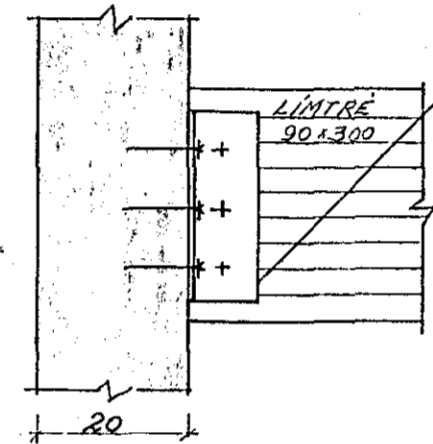

VINKLAR 80x250x6MM
BÁÐUM MEGIN VÍÐ BÍTA
MÚRBOLTAR 3 STK 1/2" Í
HVORN VINKIL. BOLTAR Í
GEGNUM VINKLA OG BÍTA
ERU 3 STK 16MM EÐA 6 STK 1/2"

6 SPERRUR/STEYPTUR VEGGUR 1:10

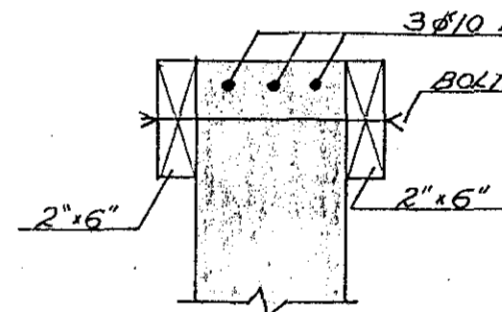

8 SPERRUR/SKÁSPERRUR 1:10

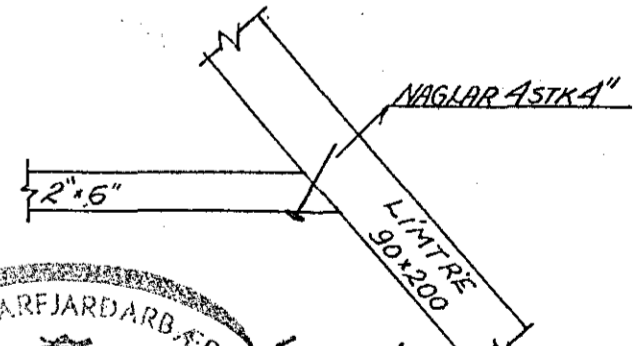

7 SKÁSPERRUR/ÚTVEGGUR 1:10

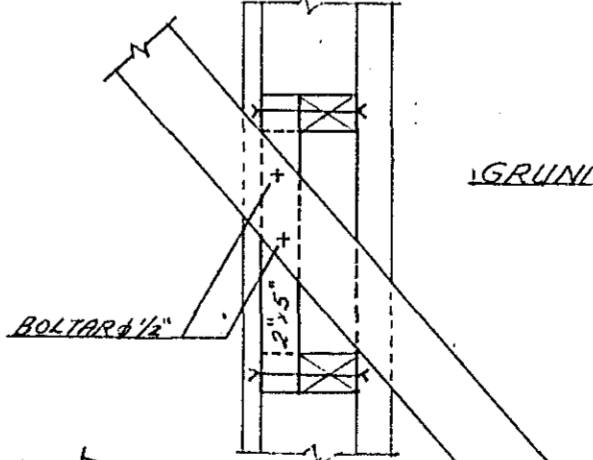

1 TENGING SÚLNA OG BÍTA 1:10

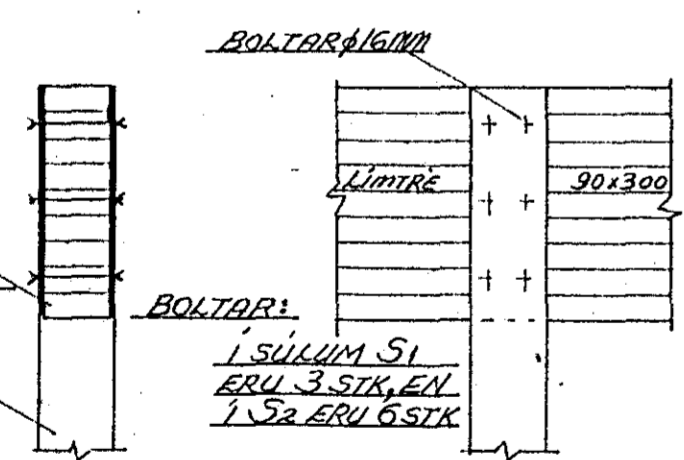

TEKID ÚR STÁL-
SÚLU OG BÍTI
EFLUÐUR NIÐUR FÁMILLI
HEIÐAR BILTANS, ÞEYÐA
SEM EFTIR VERRA.
STÁL SÚLA 100x100x4
STÁLGRÆÐI 54.37.12

2 TENGING SKÁSPERRA VÍÐ BÍTA 1:10

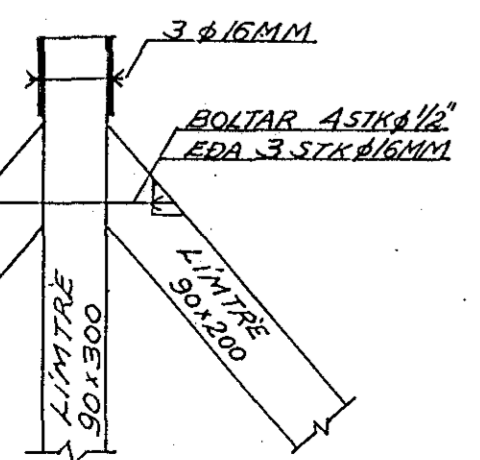

3 SPERRA/VEGGUR 1:10

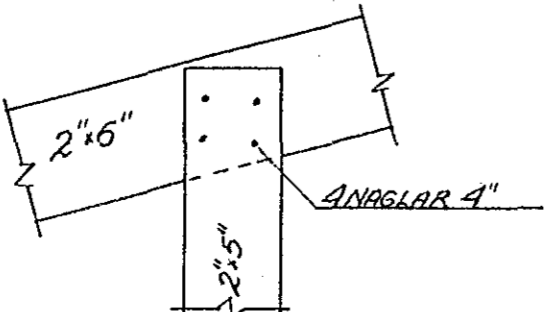

4 SPERRUR/LÍMTRÉ 1:10

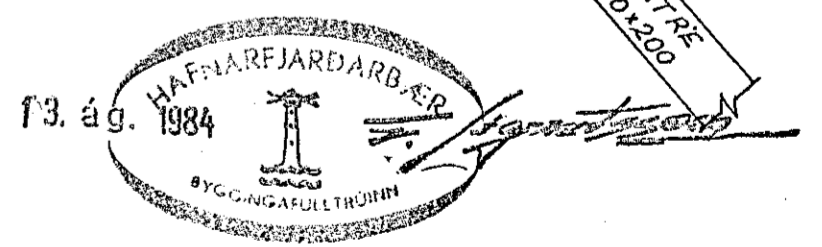
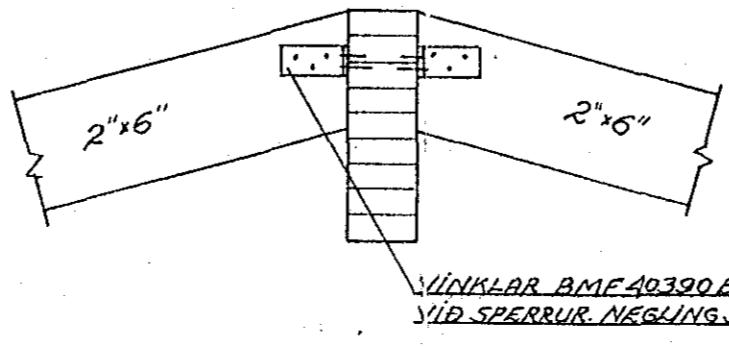

VEGGGRIND: 2"x5" 60 LÖÐRETT MÓTI SPERRUM

LJÓSABERG 2A HAFNARFIRÐI	VERK	BL.NR. 1.2.
PAKVIKRI GRUNNMYND SAMSETNINGAR	HAFNARFÉLAG MKV. 1:50	REIKNINGAR TEIKNINGAR 1:10
VERKFRÆÐISTOFFA HAUDÓRS HANNESSONAR REYKJANVÍKURVEGI 60 HAFNARFIRÐIS. 54355		