

SNID R-R
1:20

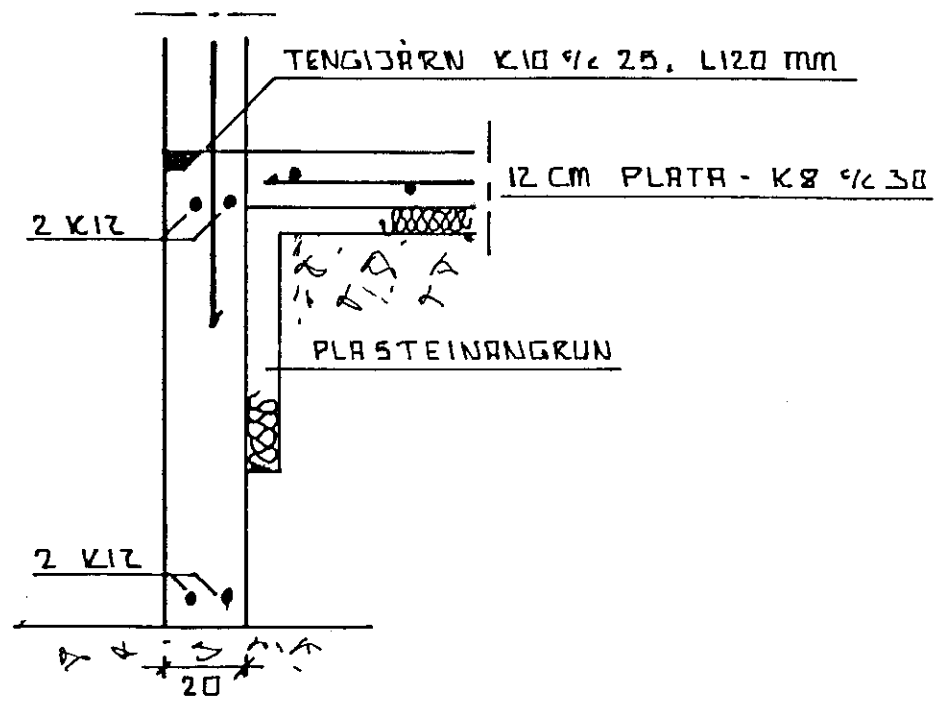

SNID B-B
1:20

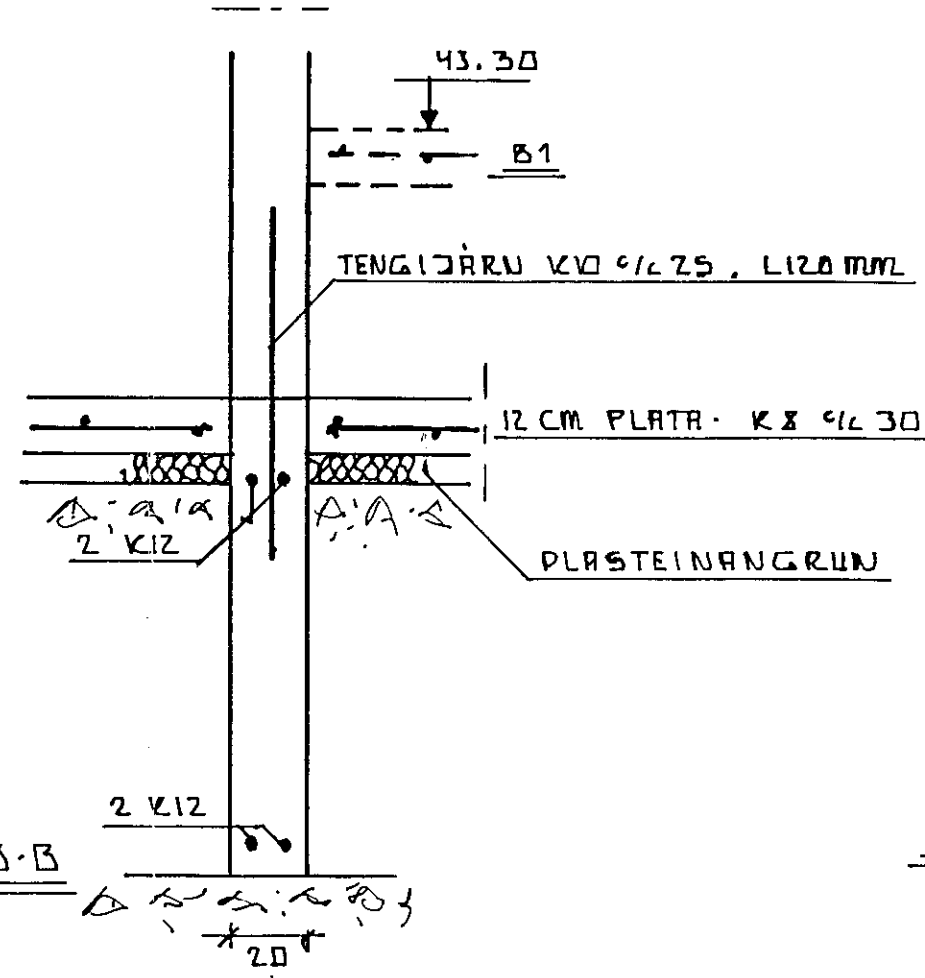

SNID D-D
1:20

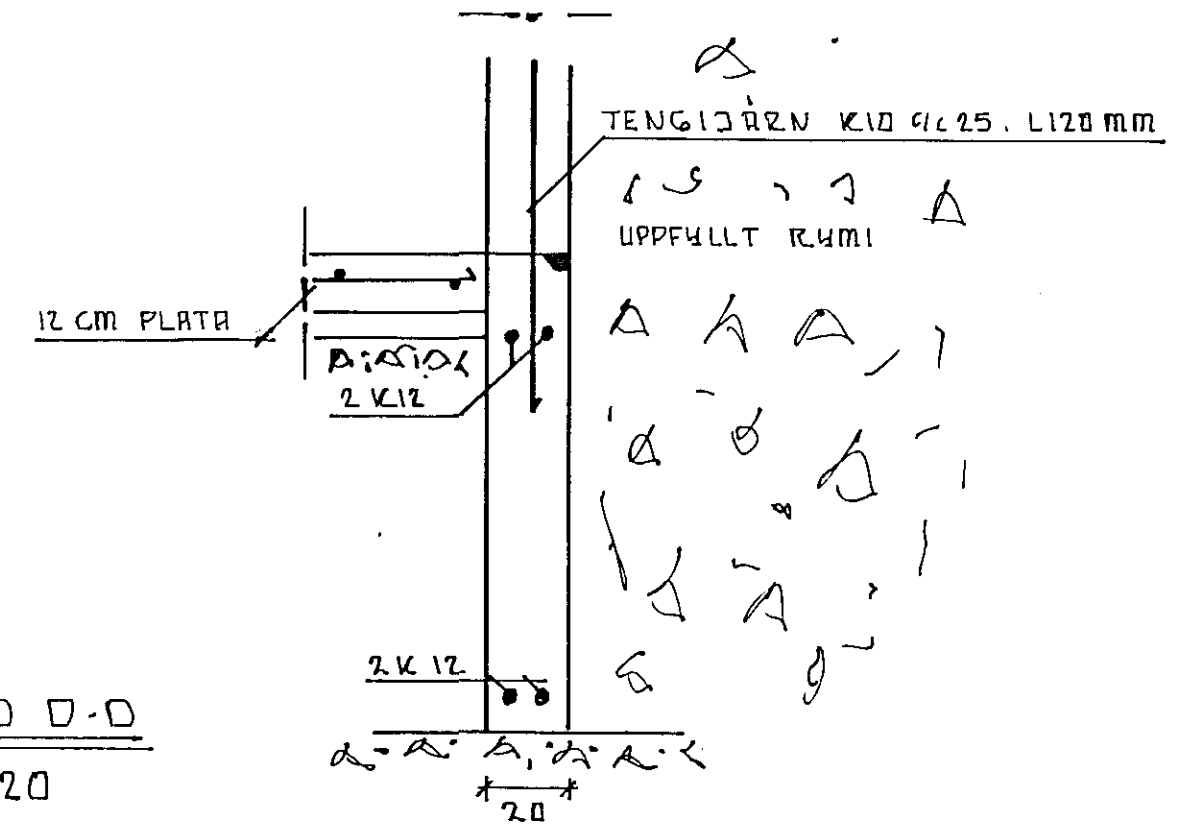

SNID C-C
1:20

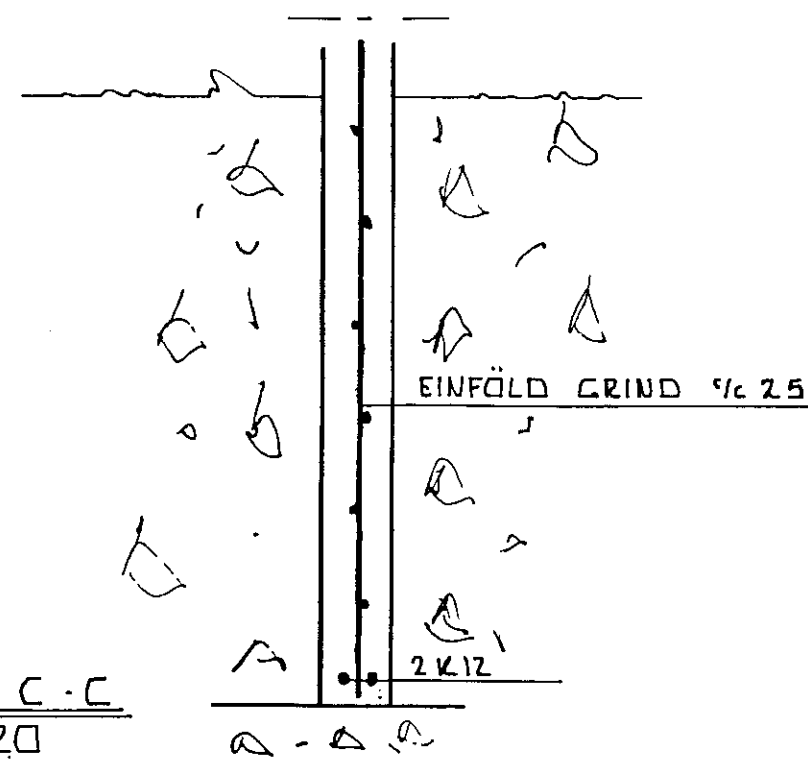

SNID S1
1:20

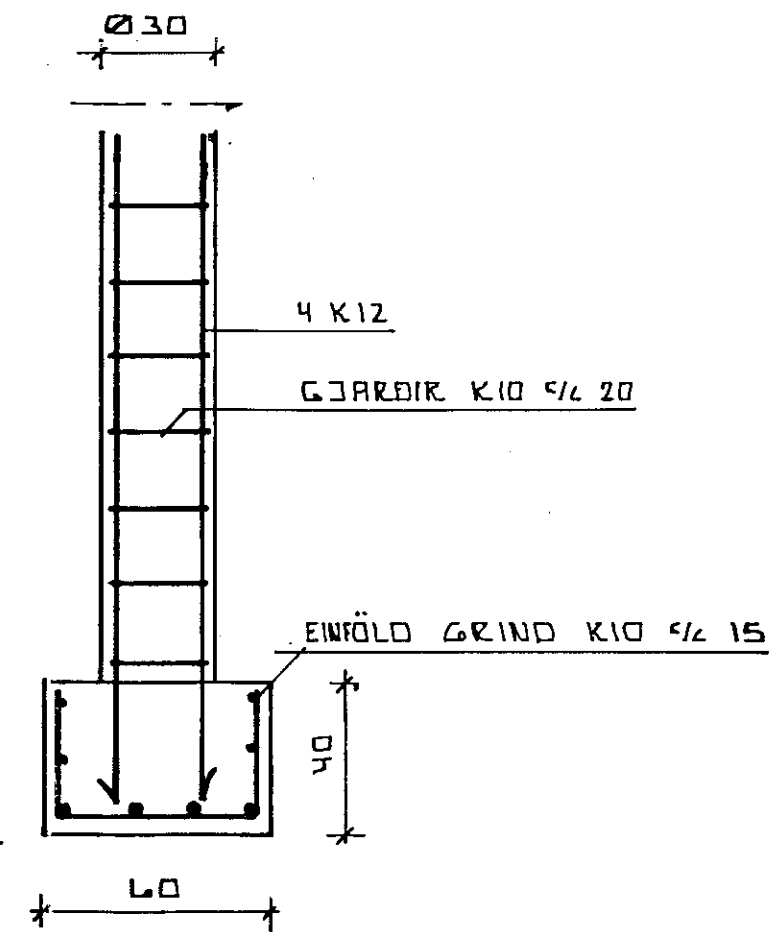

SNID S2
1:20

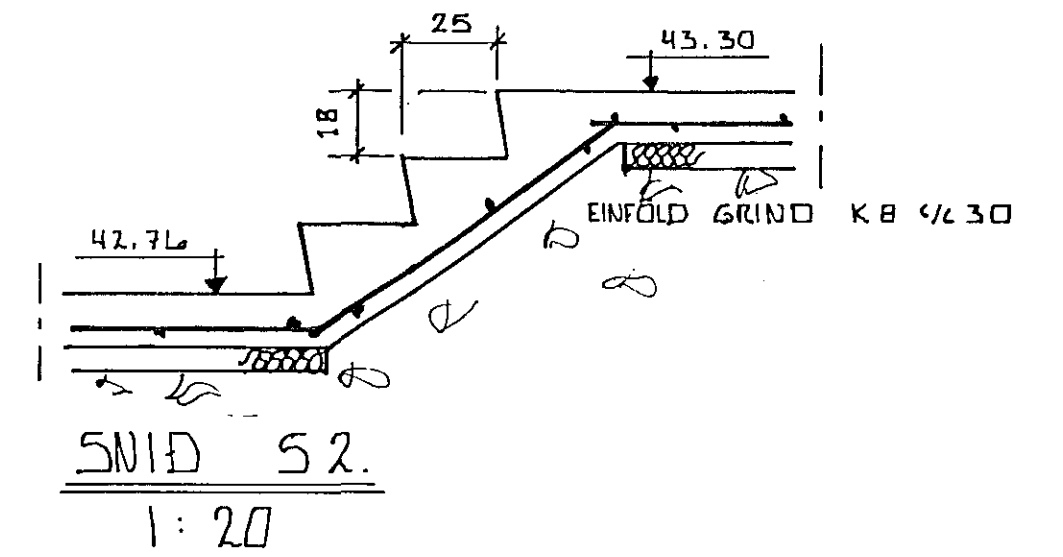

SKÝRINGAR SJÁ NR. 1.01.

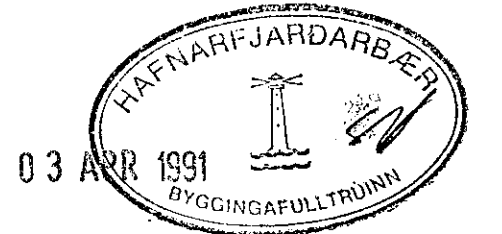

LINDARBERG 4		
UNDIRSTÖÐUR SNID		
DÓR GÍSLASON BYGGINGATEKNIFRÆÐINGUR Hjallabraut 37, 220 HF. s.652/451	NR 1.03 MKV. 1:20	SEPT 1990 Dór Gíslason