

GRUNNMÝND 1:50

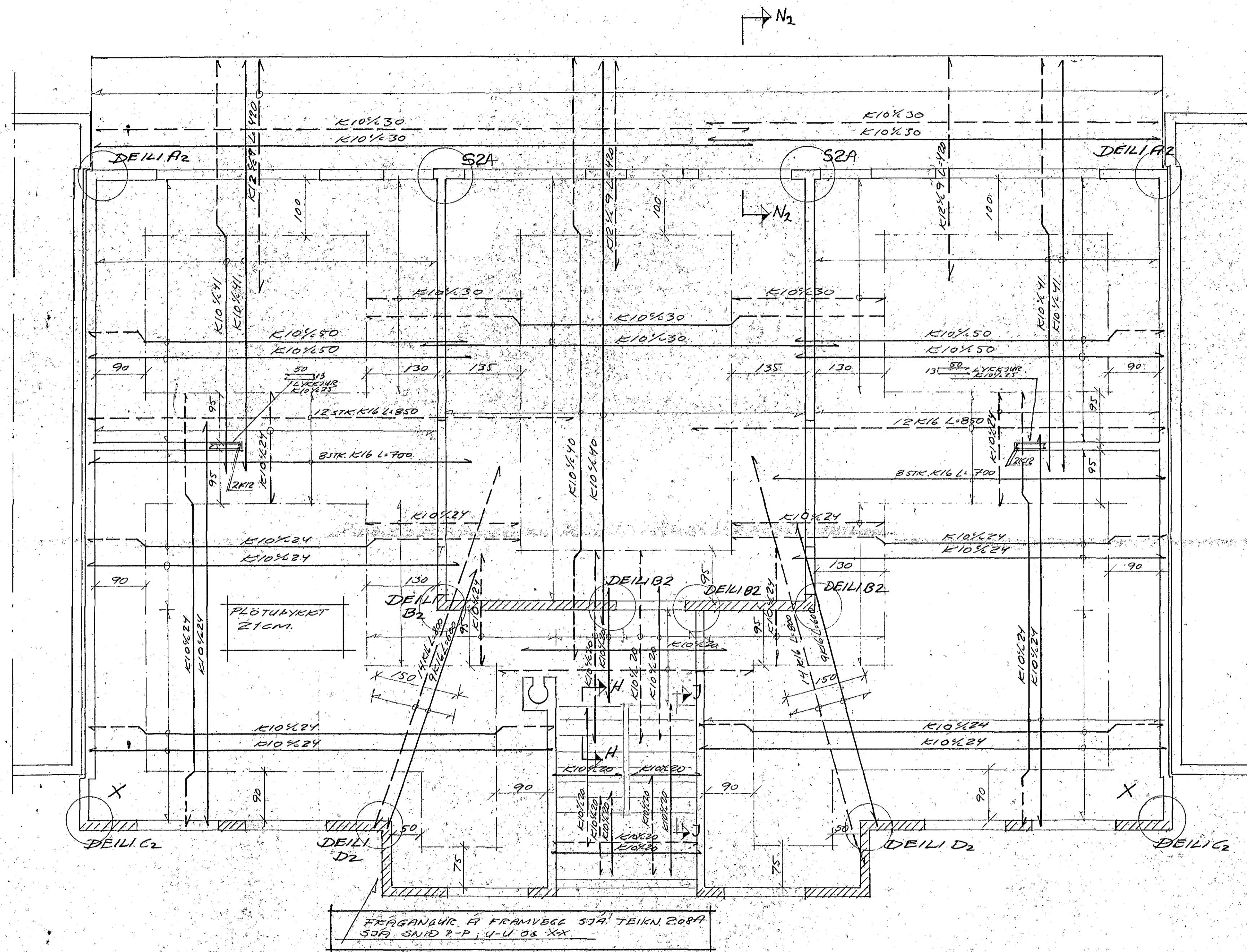

SÚLA S2A 1:20

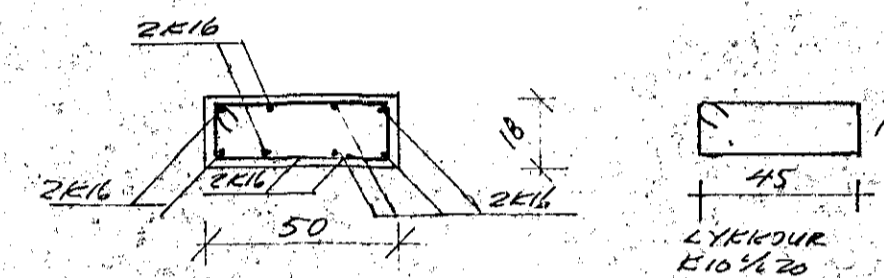

DEILI A2 1:20

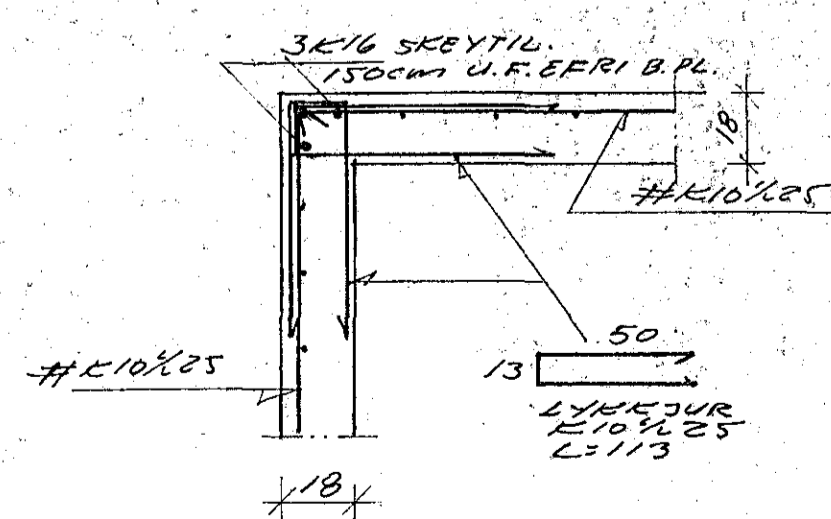

DEILI B2 1:20

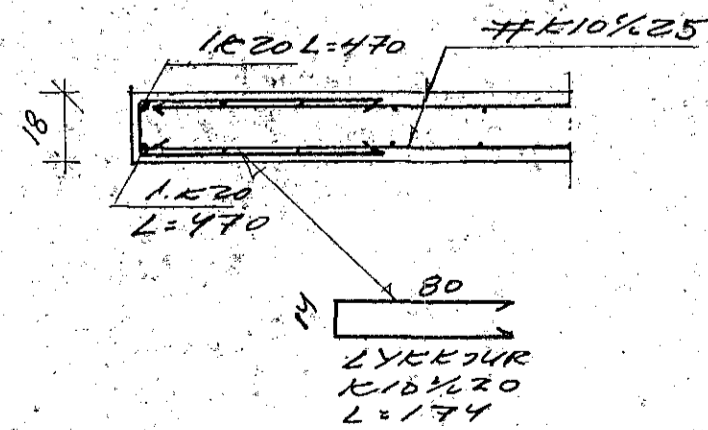

DEILI C2 1:20

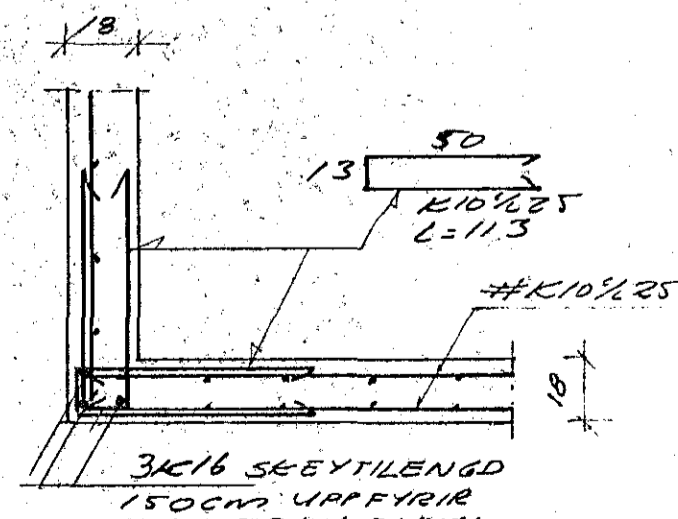

DEILI D2 1:20

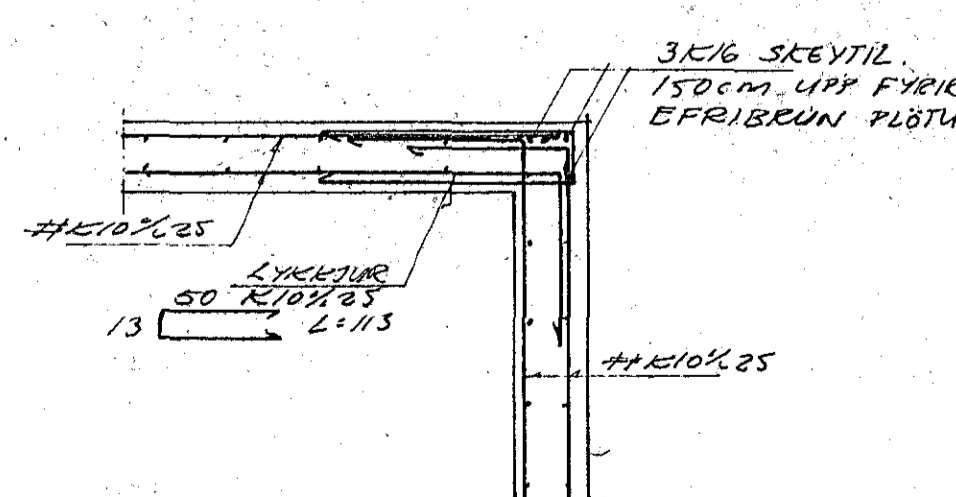

SNID G-G SJÁ TEIKN. 205A  
 SNID H-H OG J-J SJÁ TEIKN. 205A  
 1 SKRÁSTRIKADRAUGA KEMUR TÚFÖLD BENDING SJÁ DEILI A, B, C OG D.  
 2 ÚTVEGGJUM KEMUR AÐ ÖÐRU LEIÐI K10x25 # 1 ÚTVEGGJUM Á INNVEGGI KOMI K10x25 # 1  
 3 KEMUR SJÁ AÐ ÖÐRU LEIÐI TEIKN. 209A  
 SNID N2-N2 SJÁ TEIKN. 217A

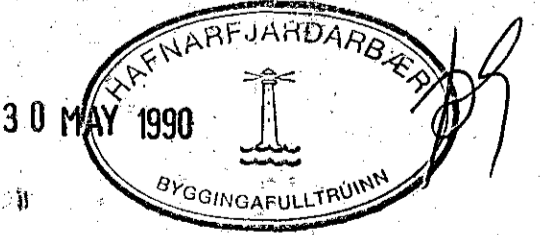

<p><b>TEIKNISTOFAN RÖDULL</b>          ARMULA 36 108 REYKJAVÍK SÍMI 33950 &amp; 33577          LEBJARGATA 34 HAFNARF.</p>	TEIKN. H4	DAGS. MAI 90
	VERK. H4	VERK.
	BLAD. 2.18A	
PLATA YFIR 3. HÆÐ HÚS - B	SKV. 1:50	