

SNID E  
1:50

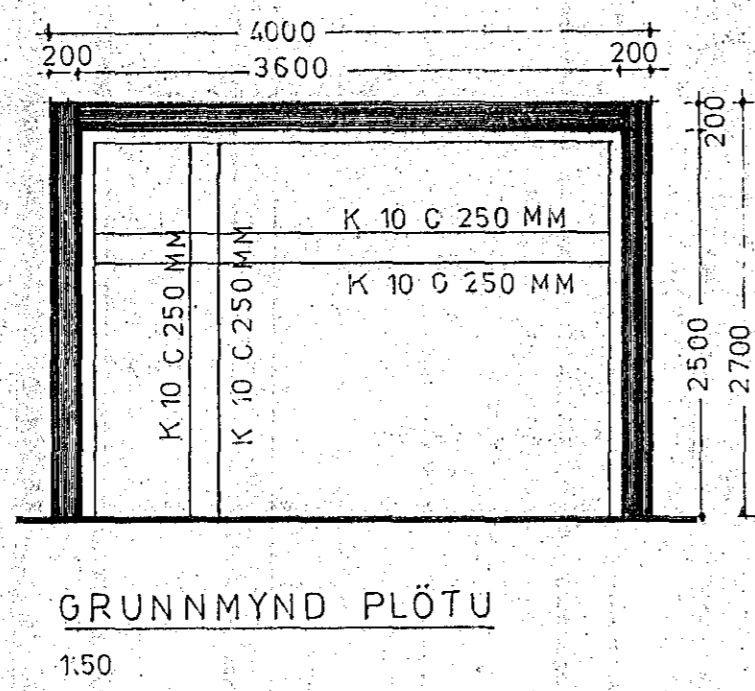

GRUNNMYND PLÖTU  
1:50

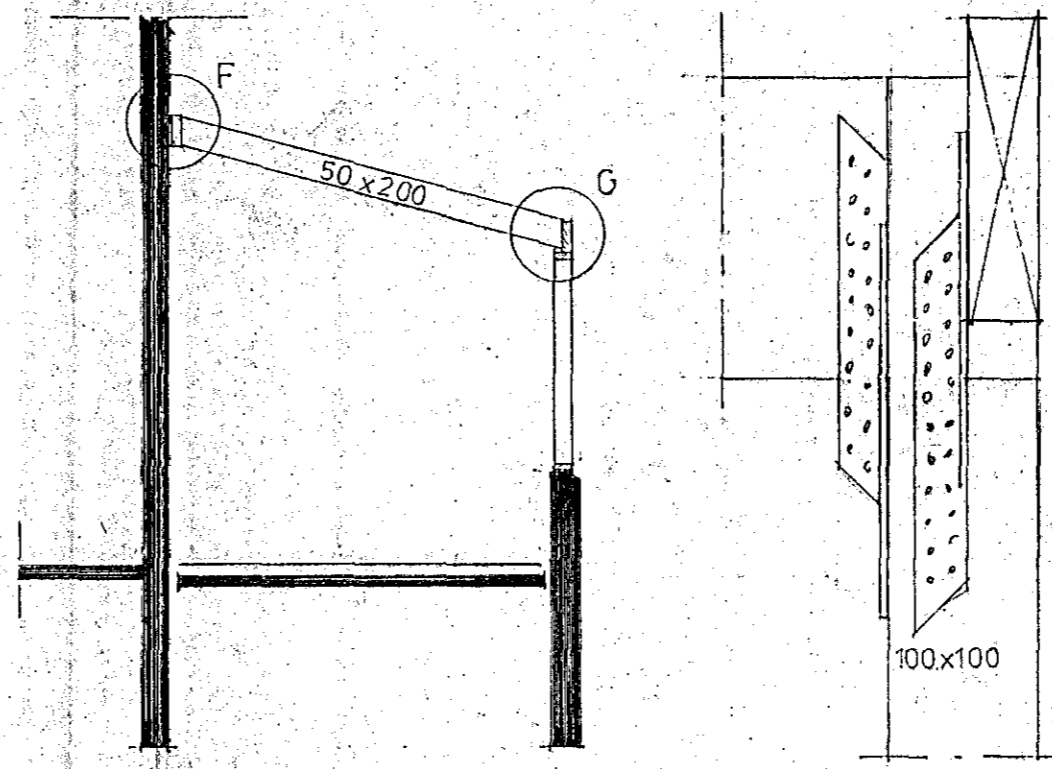

SNEIDING A-A

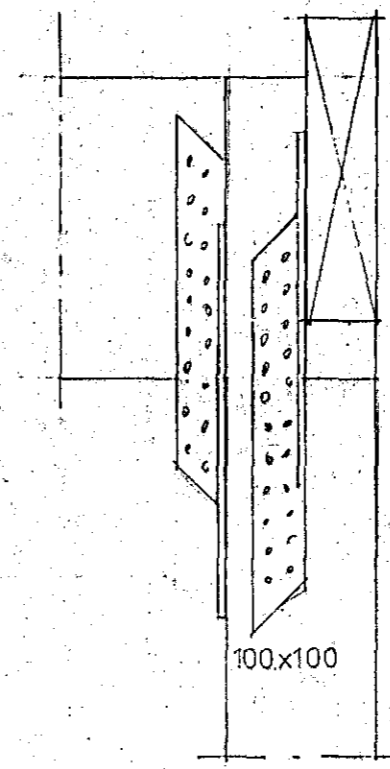

MYND-G

2 STK. BMF TAGASEANKER  
NR 250 FEST MED 2x6  
40/40 KAMSAUM.

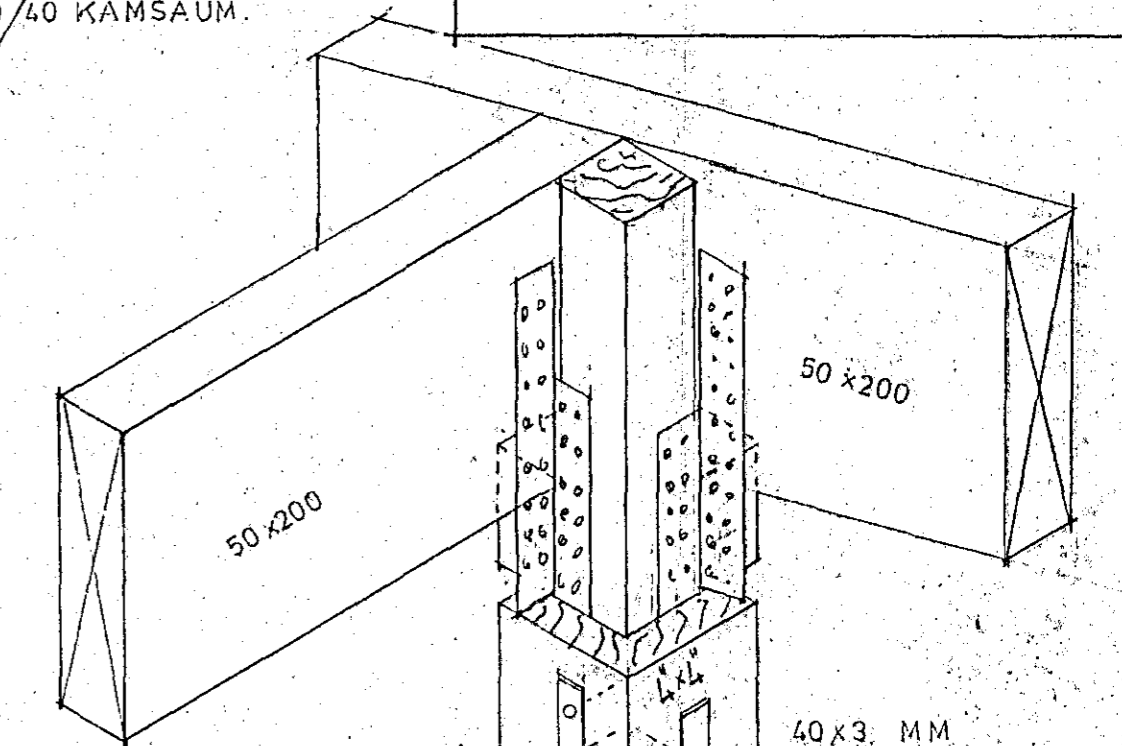

MYND-G

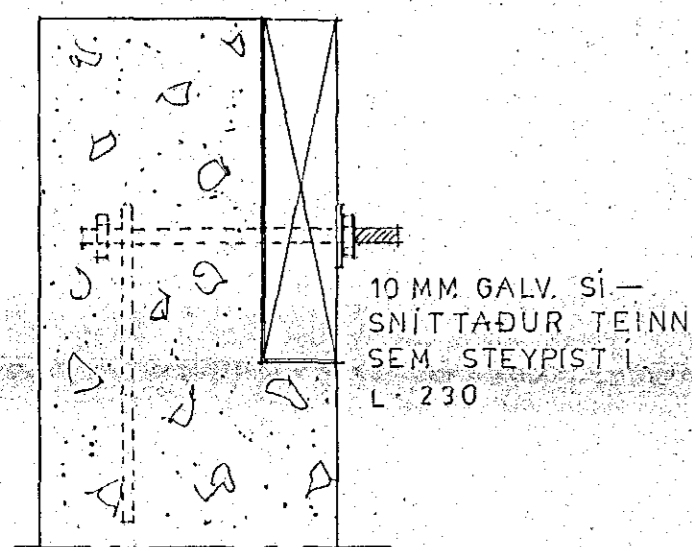

10 MM GALV. SI-SNITTADUR TEINN SEM STEYPIST I L-230

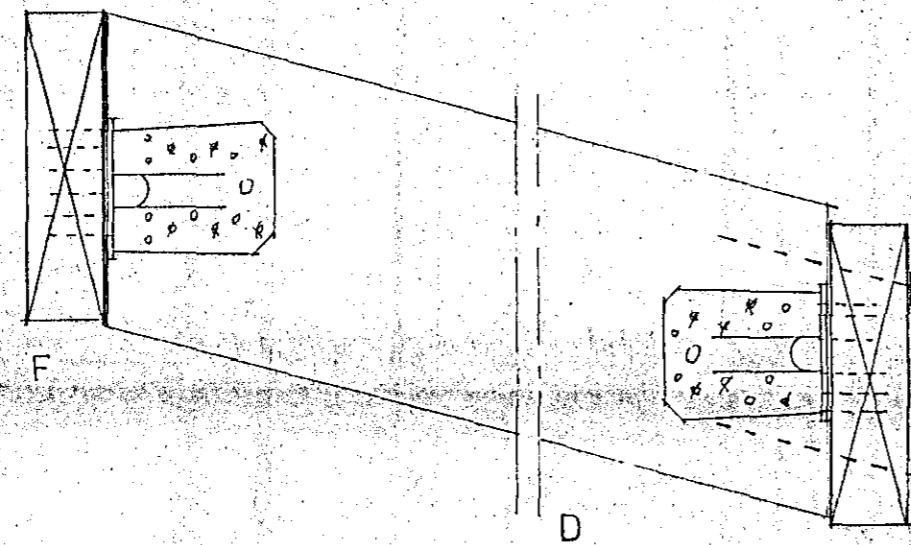

12 MM MURBOLTI L-140

50x200

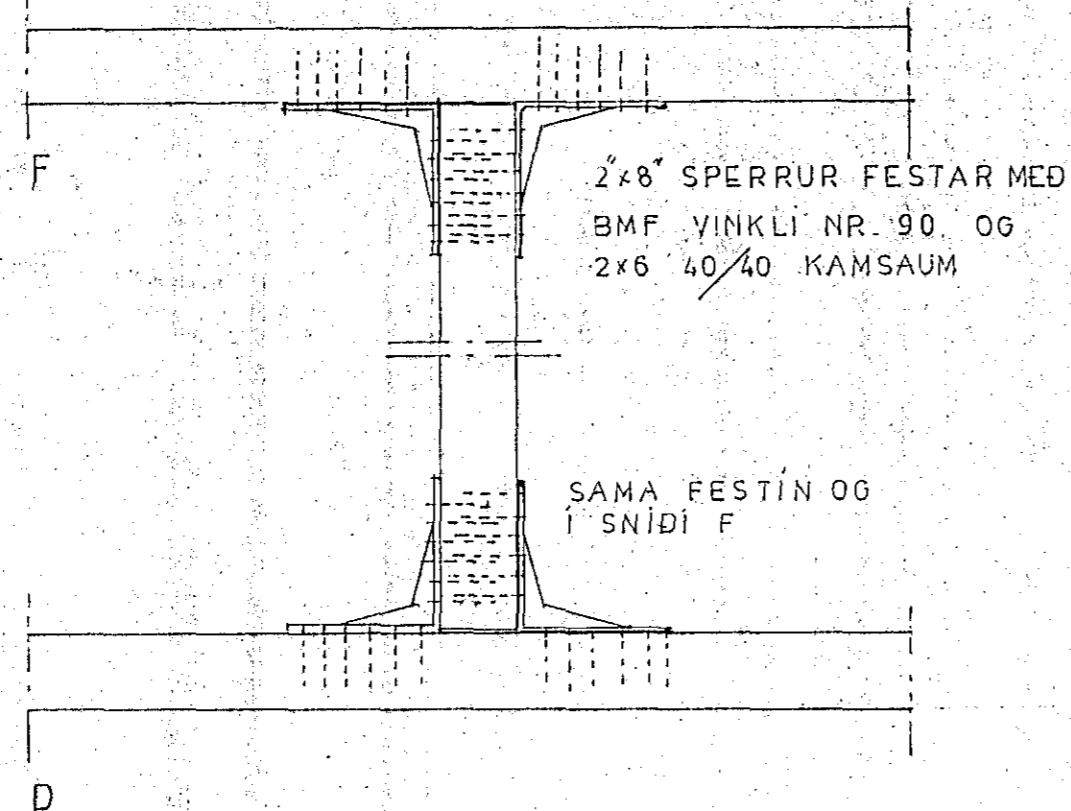

2x8 SPERRUR FESTAR MED BMF YINKLI NR. 90 OG 2x6 40/40 KAMSAUM

SAMA FESTIN OG I SNIDI F

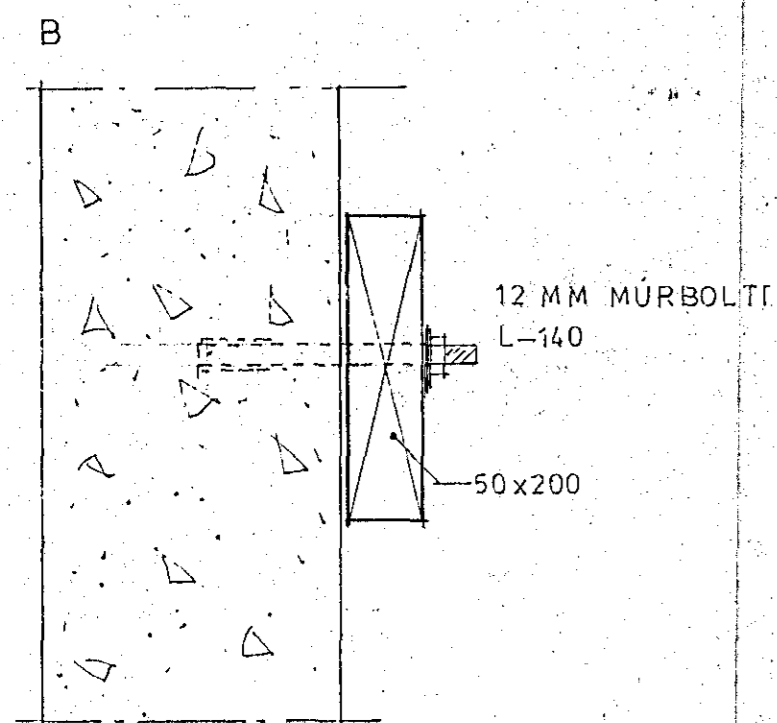

12 MM MURBOLTI L-140

50x200

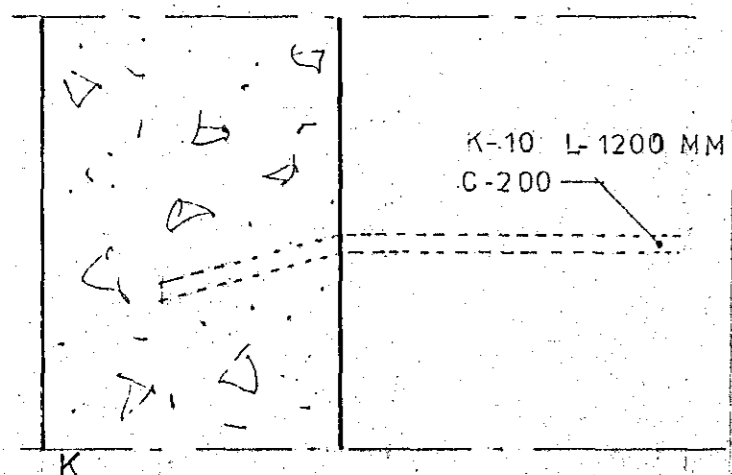

K-10 L-1200 MM C-200

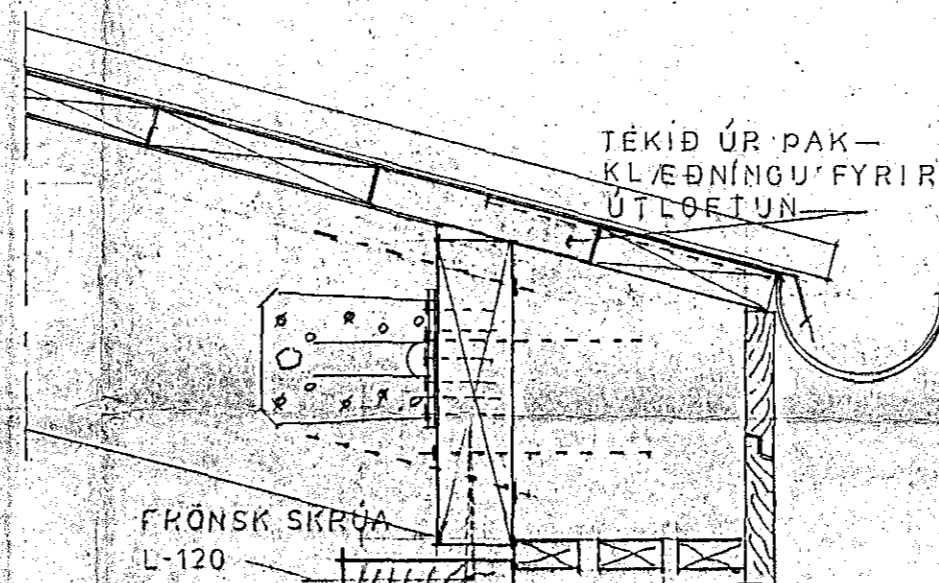

TÉKID ÚR PAK- KLÆÐNINGU FYRIR ÚTLÖFTUN

FRÖNSK SKRUA L-120 C 80

10 MM MURB L-120 C 80

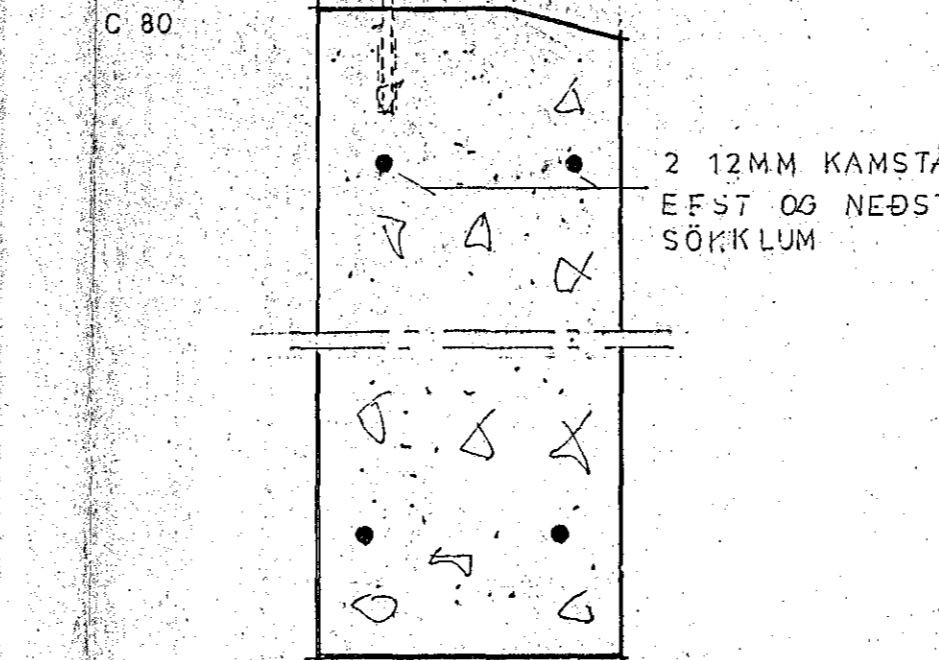

2 12MM KAMSTÁL EFST OG NEÐST I SÖKKLUM

MYND-H

12 JUL 1988  
HAFNARFJÁRDARBERG  
BYGGINGAFULLTRÚI

LÆKJARKINN 24 HAFN.		
SÓLSTOFA	DAGS.	11.07'88
KRISTJÁN ÞÓRARINSSON BYGGINGAFRÆÐINGUR Lækjarkinn 24 220 Hafnarfjörður Nnr.: 5891-5688 ☎ 91-652295	KVARDI	1:50 1:5
	TEIKN.NR.	01

*Kristján Þórarinsson*