

Grunnmynd sökklá
mkv. 1:50

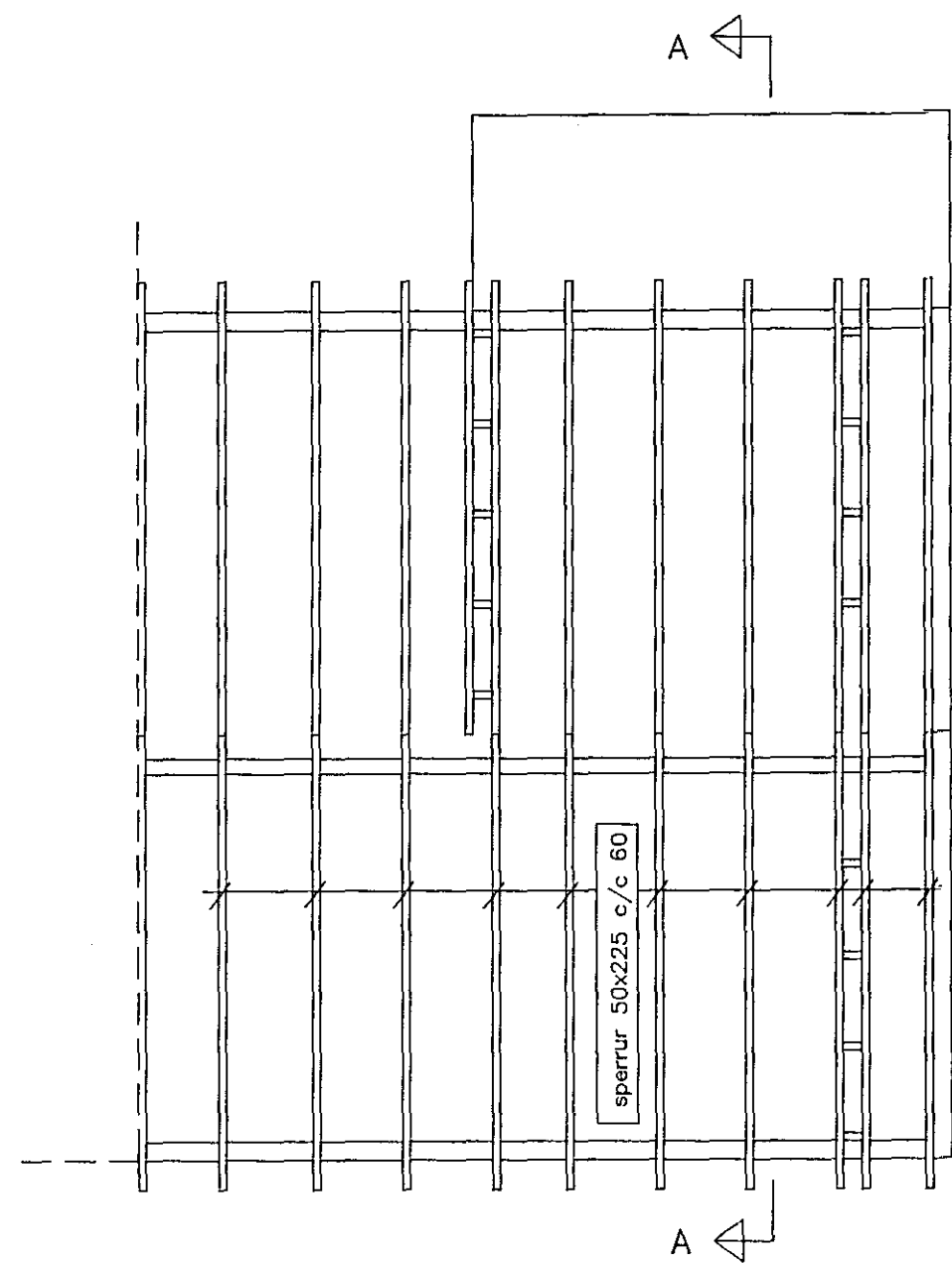

Grunnmynd þakviða
mkv. 1:50

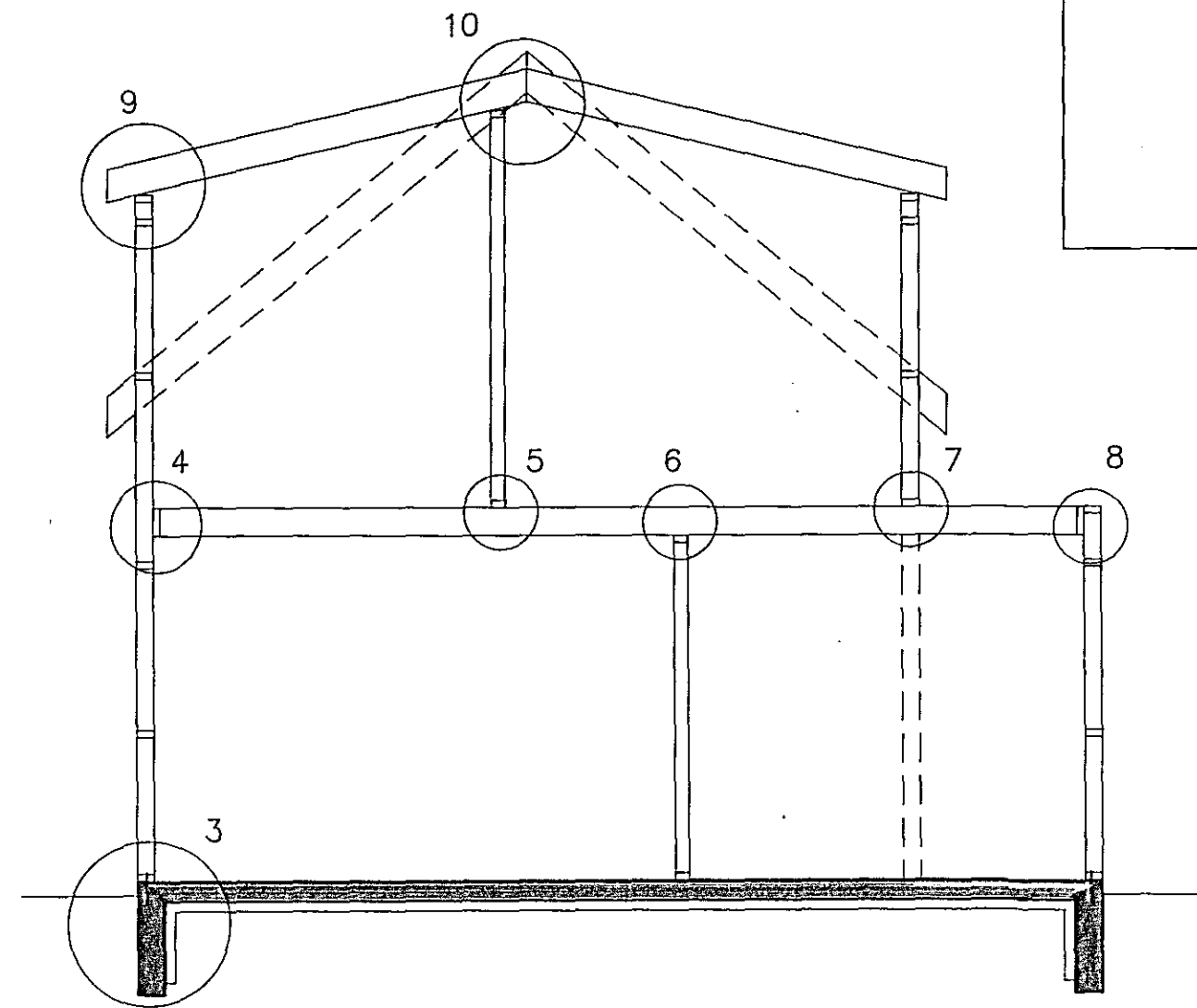

Snið A - A
mkv. 1:50

ATH!
Öll mál á grind skal samræma teikningum arkitekts og mælingum á staðnum.

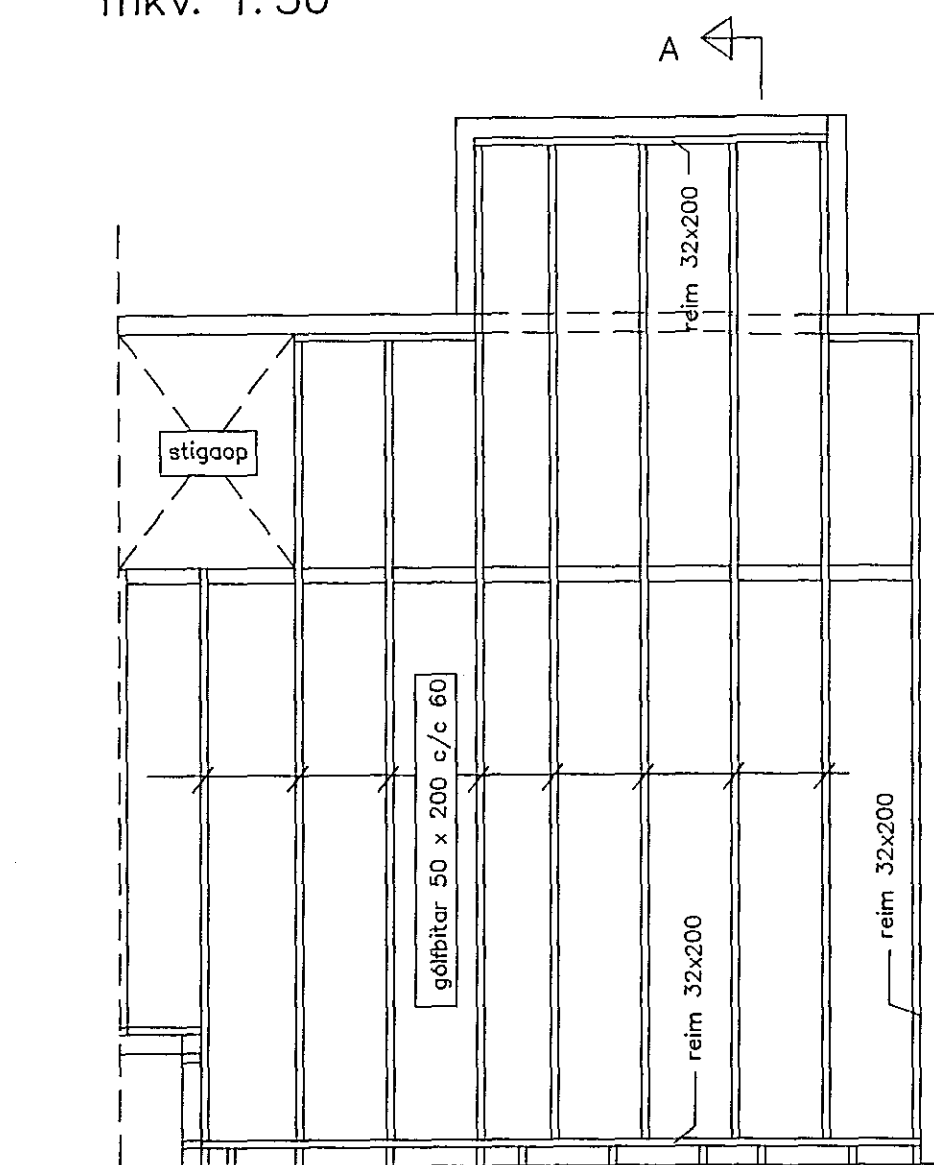

Grunnmynd milligólfs
mkv. 1:50

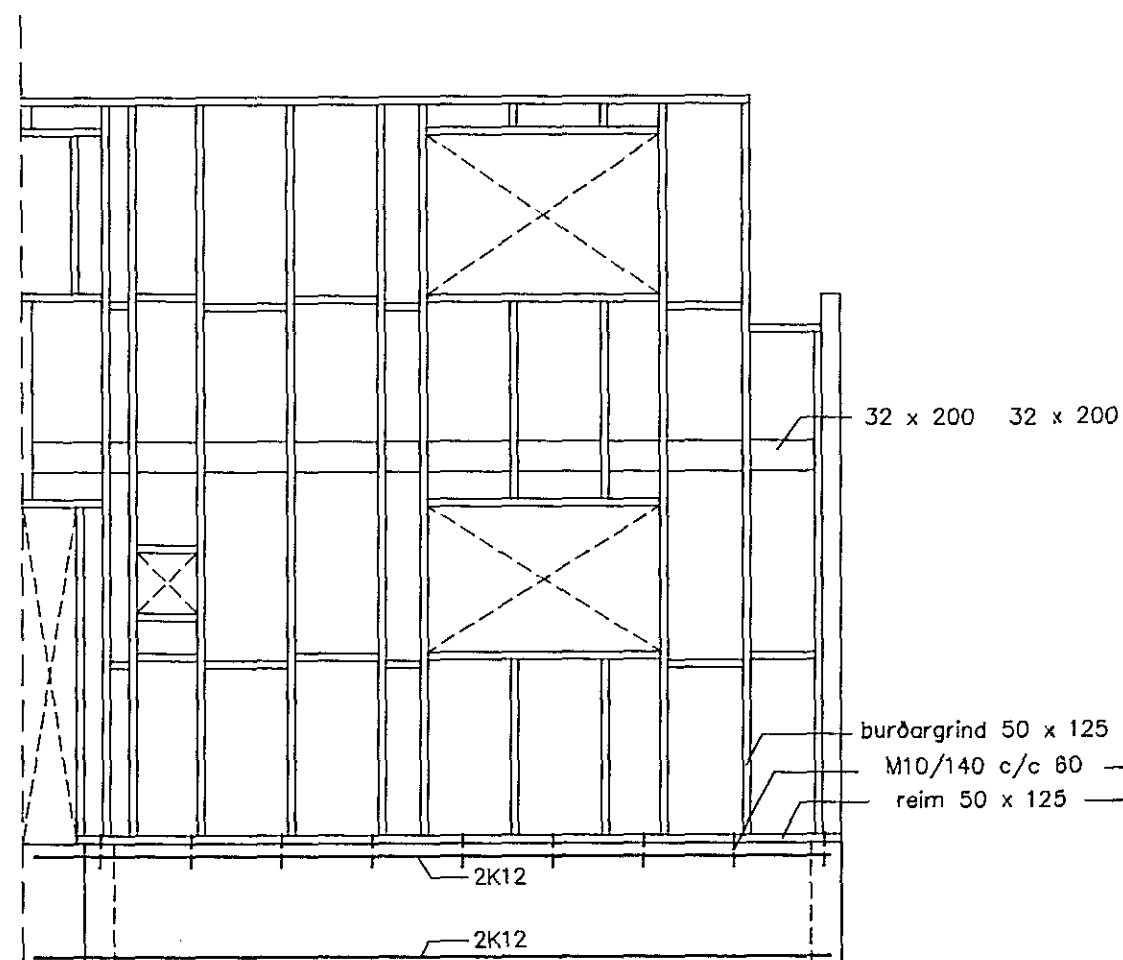

Burðarvirki norðurhliðar
mkv. 1:50

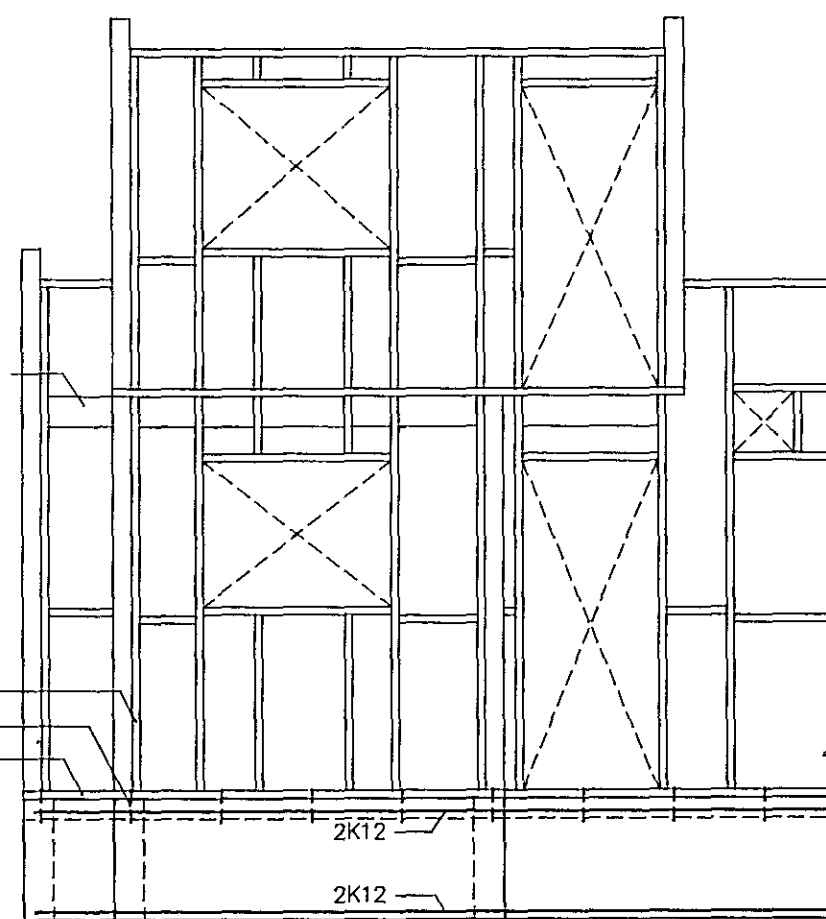

Burðarvirki suðurhliðar
mkv. 1:50

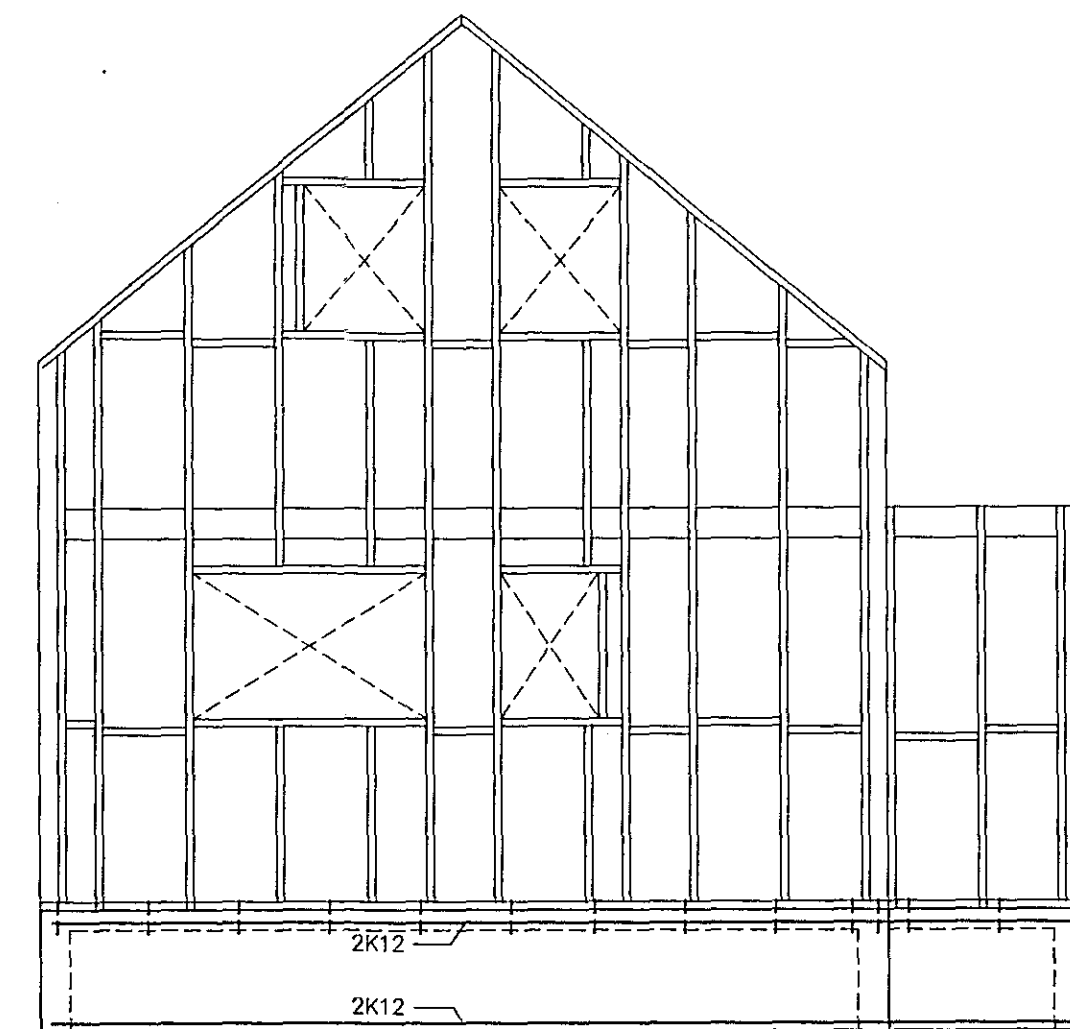

Burðarvirki vesturhliðar
mkv. 1:50

TILVÍSANIR:
Sjá almennar skýringar og snið á teikningu nr. 602.
Sjá fræðennislagningar í jörð á teikningu nr. 701.

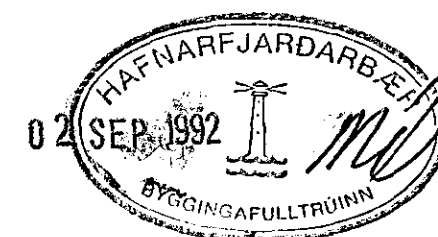

A: 31.08.92. Smávægilegar lagfæringar gerðar á grind.

**TEIKNISTOFAN
TORGID**
RÁÐGJÖF - HÖNNUN - EFTIRLIT
ARMÓU 36, 108 REYKJAVÍK, Sími 91-888866, FAX 91-888878
Þorsteinn Friðbjórnsson, Magnús Þ. Guðmundsson,
Byggingateknifélagur, Innviðasakirki.

VERK:	Suðurgata 51, viðbygging Hafnarfirði
TEIKNING:	Burðarvirki grunnmynd og snið
TEIKN. NR.:	601
DAGS:	20.08.92.
BREYTT:	A
KVARDI:	1:50/20
VERK NR.:	92-816
HANNAD:	ÞF