

SKURÐUR D-D, M=1:20

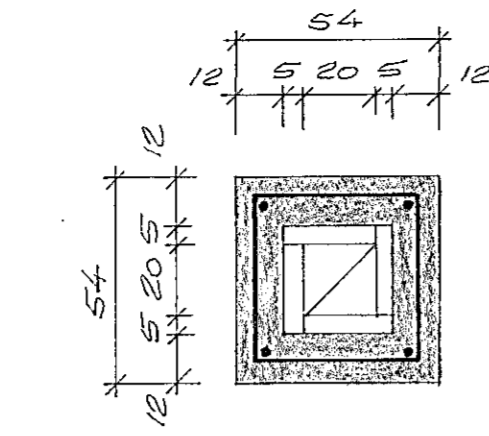

SKURÐUR A-A, M=1:20

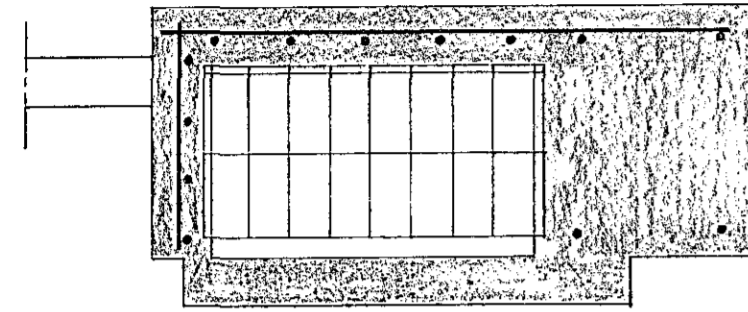

SKURÐUR C-C, M=1:20

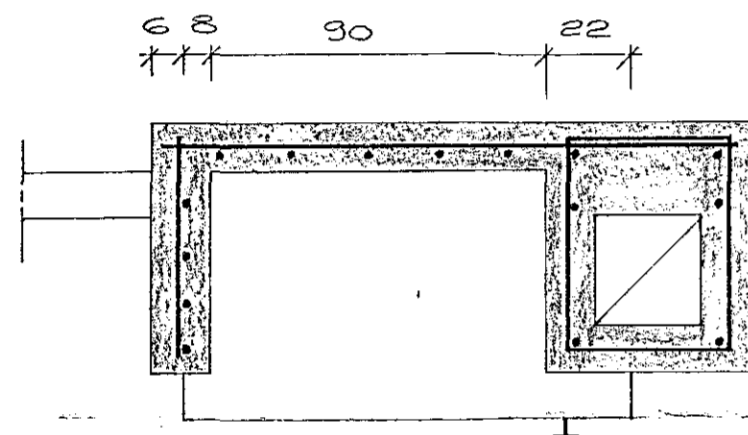

SKURÐUR B-B, M=1:20

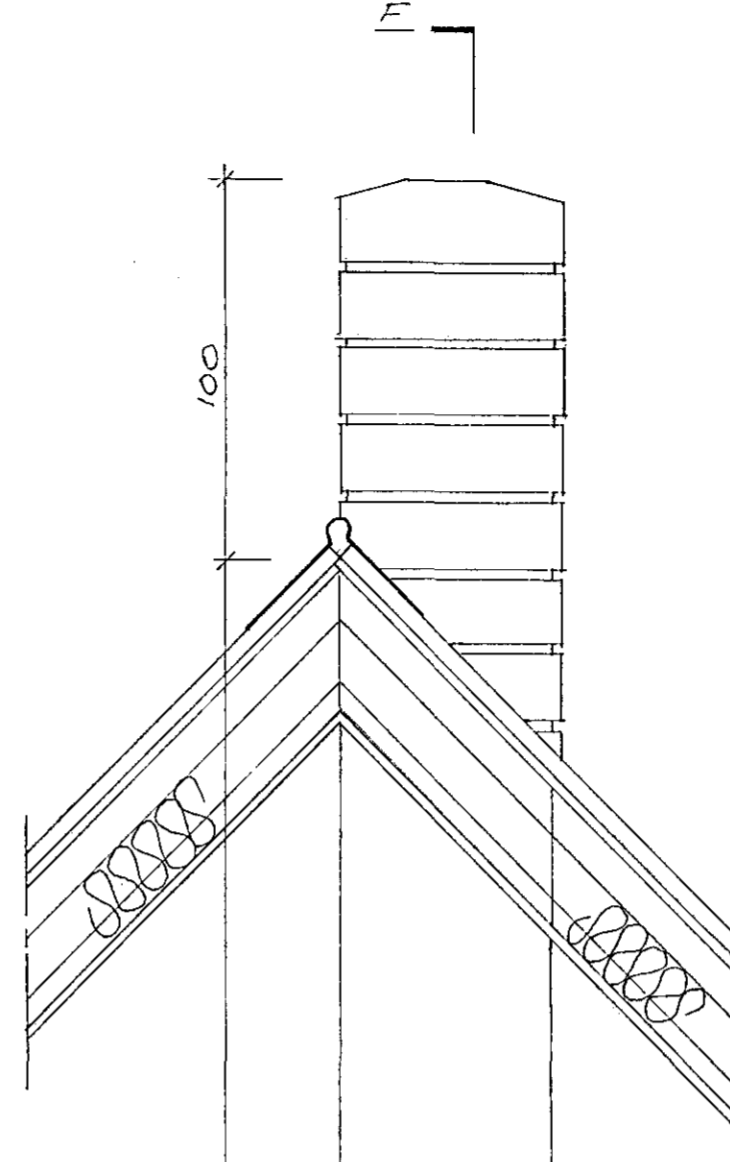
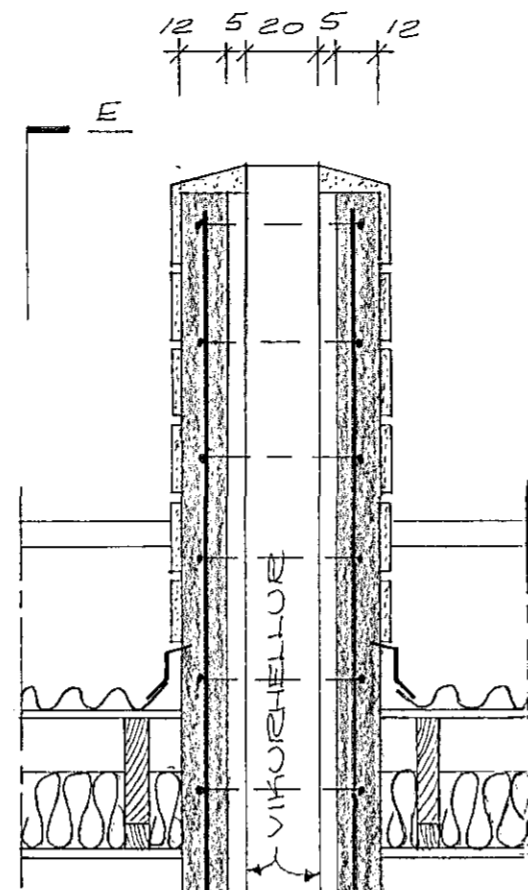

STEINSTEYPA : 5200  
BENDISTÁL : KS 40 , ST 37  
ELDFASTIR STEINAR : (1" x 110 x 220 MM) OG  
ELDFASTUR LEIR , SVÖ OG ARIÐSPJALD  
(225 x 225 MM) FEST HJÁ BIERING.  
HLÍF TIL VARUAR NEISTAFLUGI FRAM Í  
STOFU, EFTIR NOTSUN ARIÐS, FEST HJÁ  
TRANSIT TRADING.

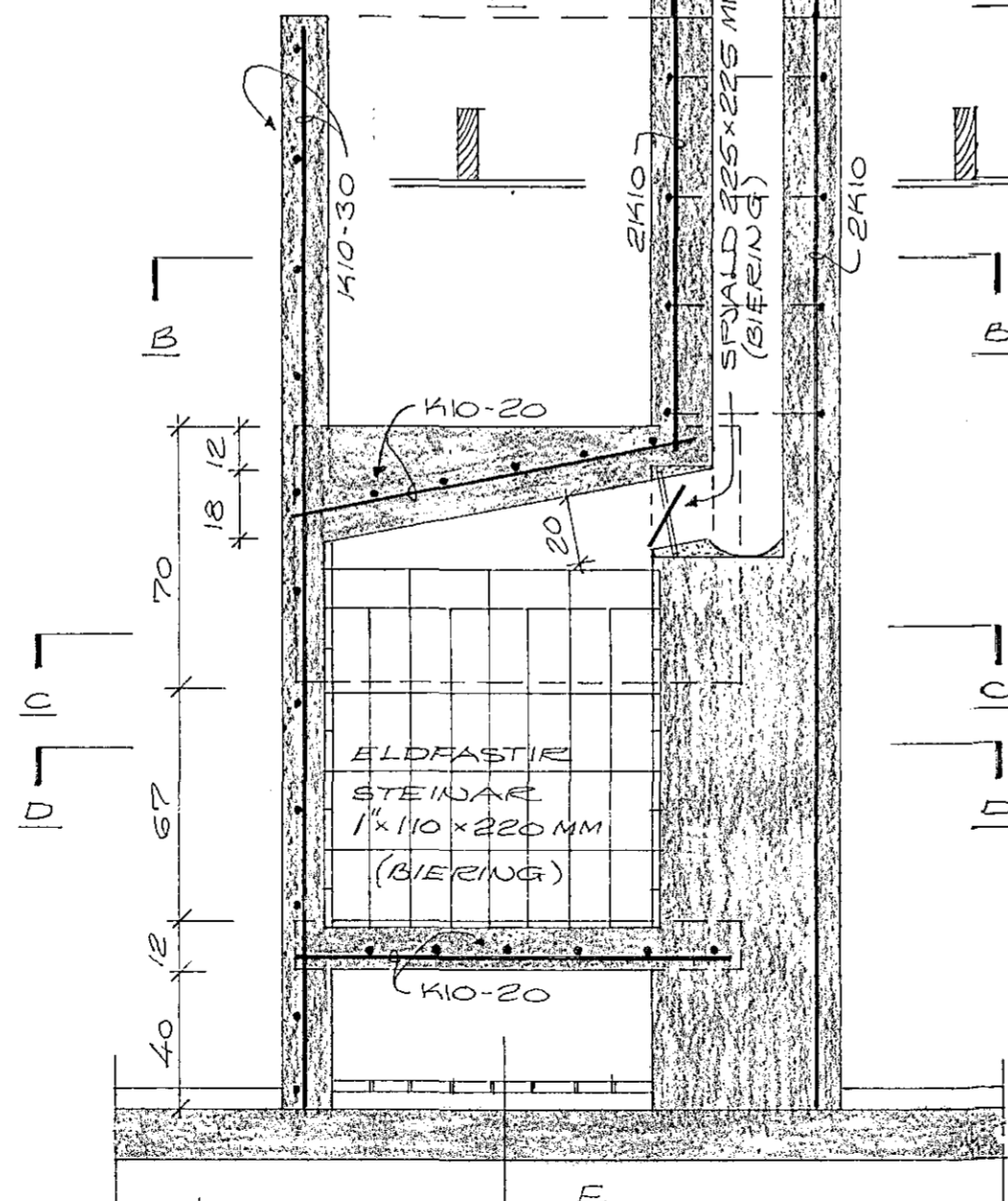

SKURÐUR F-F, M=1:20

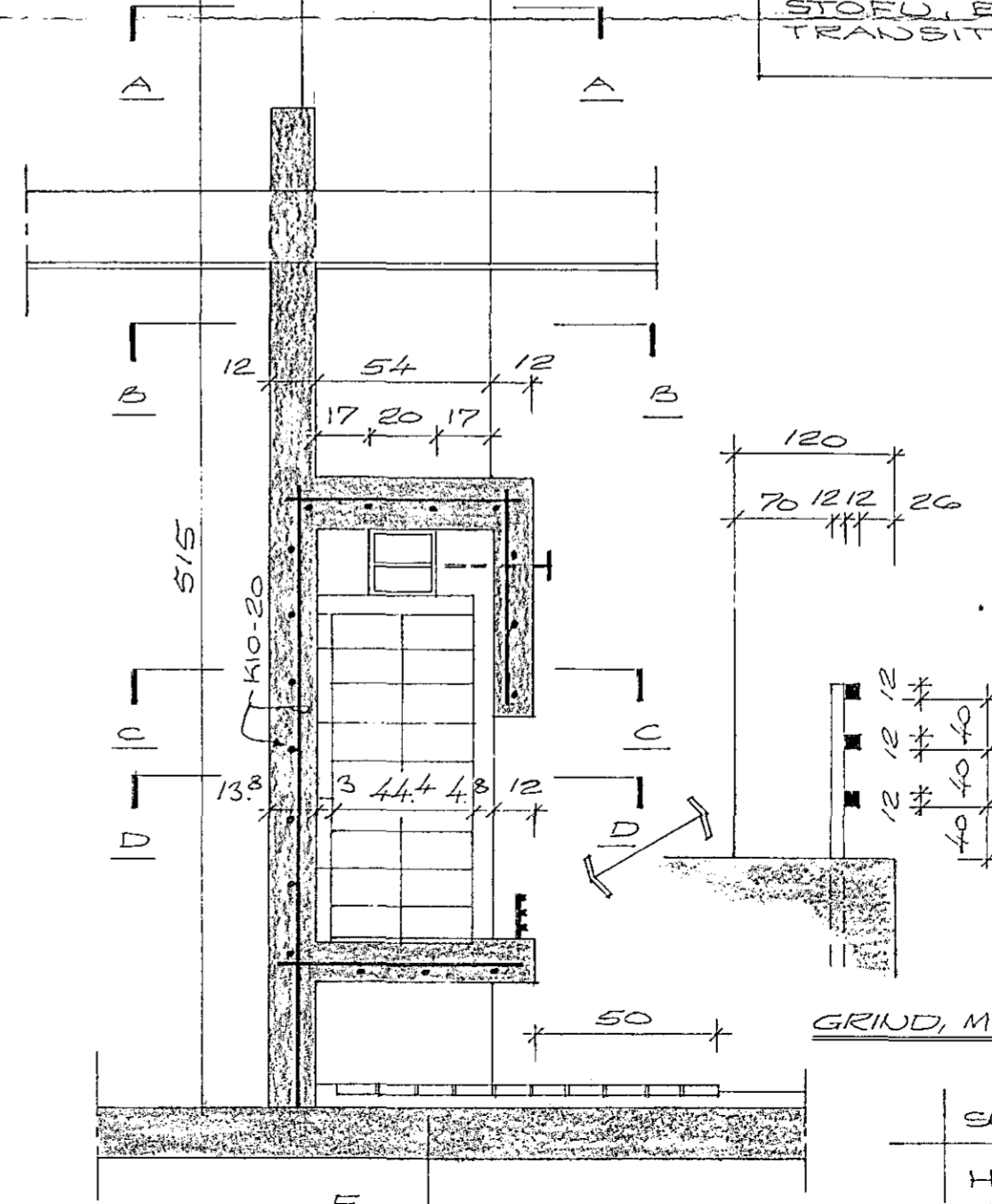

SKURÐUR E-E, M=1:20

SÚÐURVANGUR NR. 5

HAFNARFJÓRÐI Í MARS 1982  
ARNARHRAUNI 47, 50587

ARIÐU

*Arnar Magnússon*