

G-1, 4 stk. Bilskúr.
Efri brún 2100 mm frá gólfi.

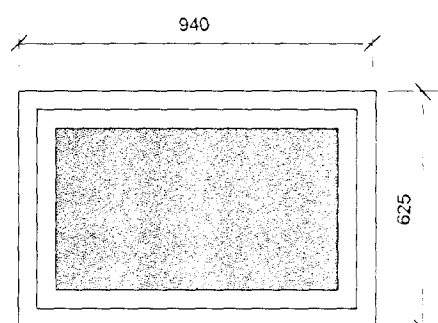

G-17, 2 stk. Bilsk/búr.
Efri brún 2100 mm frá gólfi.

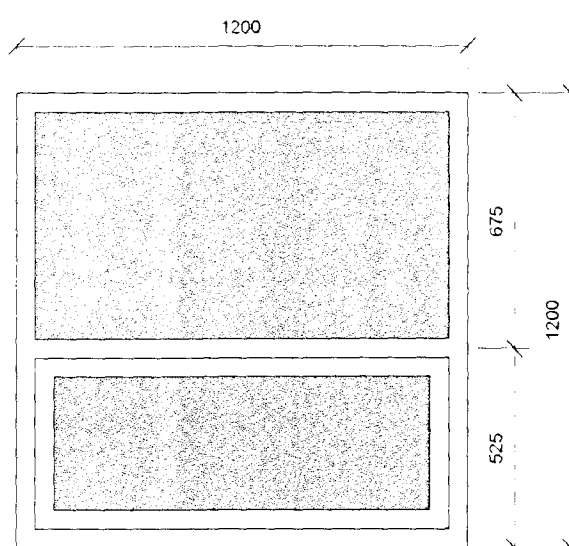

G-2, 1 stk. Eldh.
Efri brún 2100 mm frá gólfi.

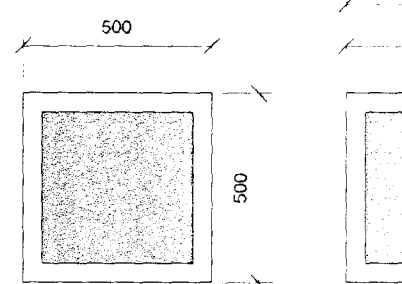

G-3, 1 stk. Eldh.
Efri brún 1400 mm frá gólfi. Settur saman við G-13 skv. deili 1. Horngl.

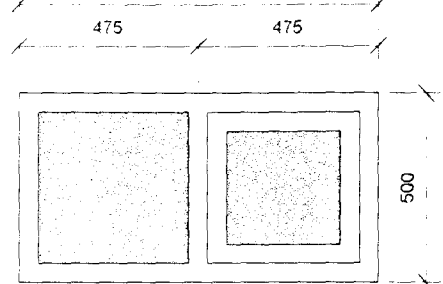

G-13, 1 stk. Eldh.
Efri brún 1400 mm frá gólfi. Settur saman við G-3 skv. deili 1. Horngl.

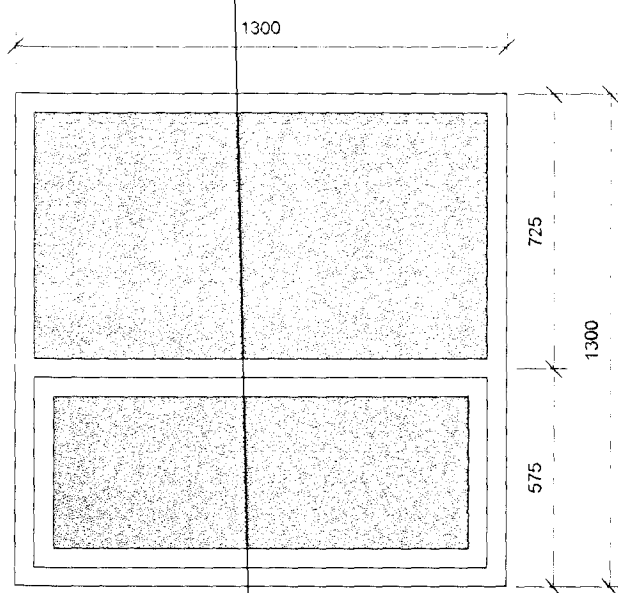

G-9, 2 stk. Þvottah./herb.
Efri brún 2200 mm frá gólfi.

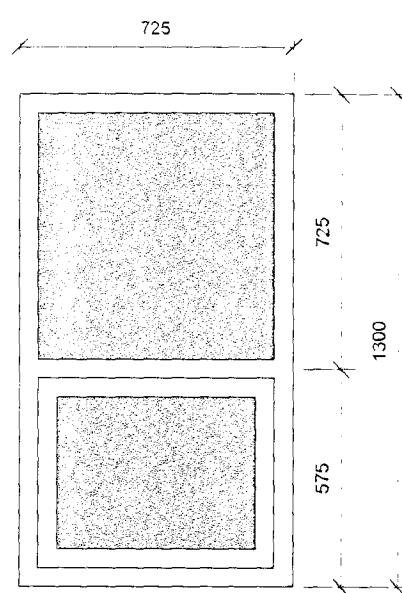

G-10, 1 stk. Herb.
Efri brún 2200 mm frá gólfi.

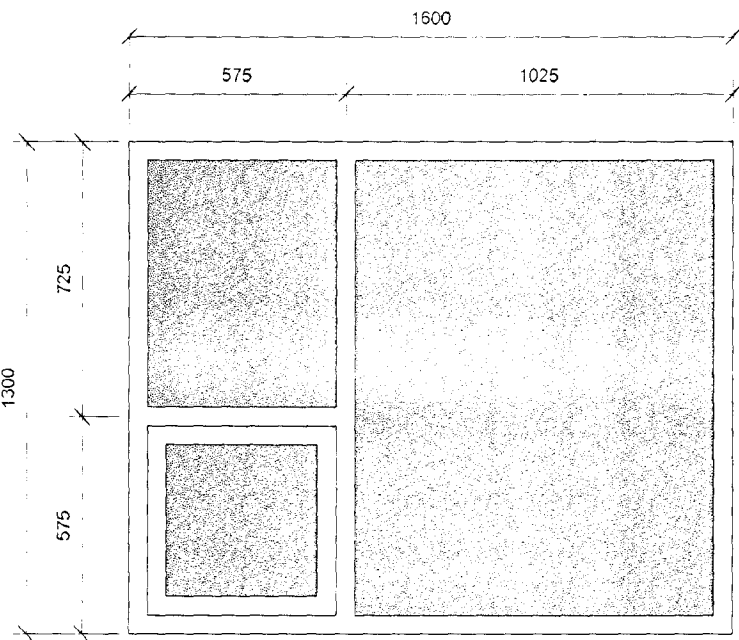

G-11, 3 stk. Hjónah./herb.
Efri brún 2200 mm frá gólfi.

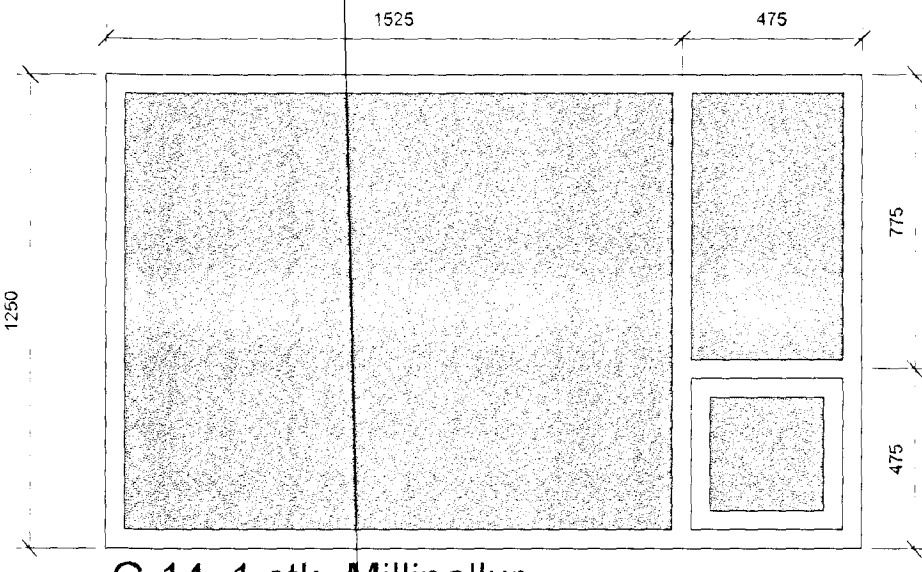

G-14, 1 stk. Millipallur
Efri brún 2000 mm frá gólfi.

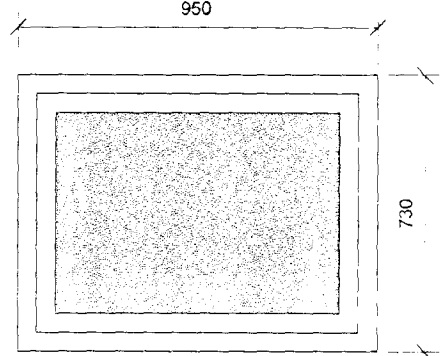

G-12, 1 stk. Bað.
Efri brún 2200 mm frá gólfi.

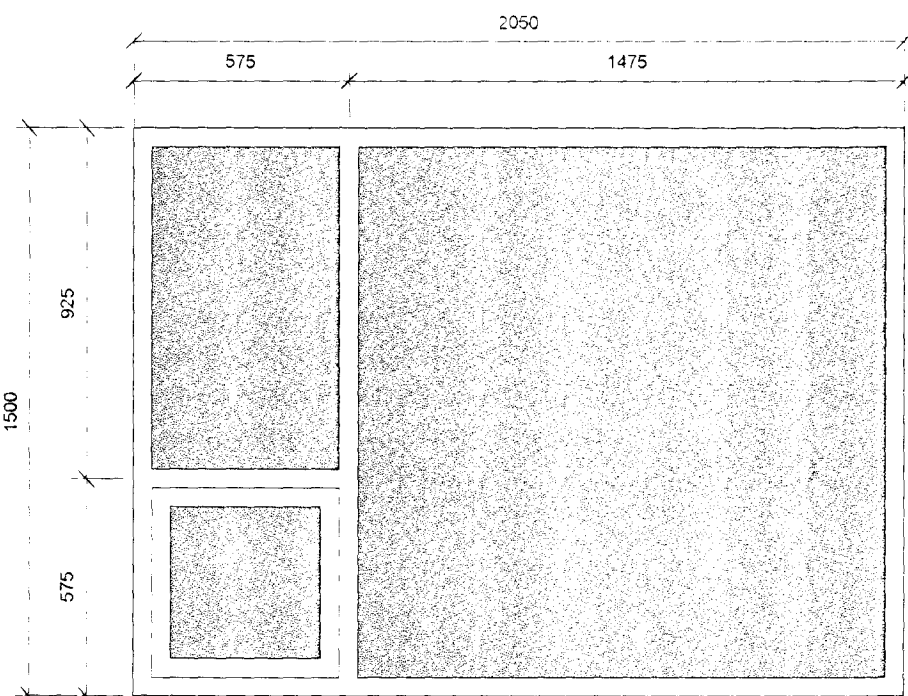

G-7, 1 stk. Herb.
Efri brún 2200 mm frá gólfi.

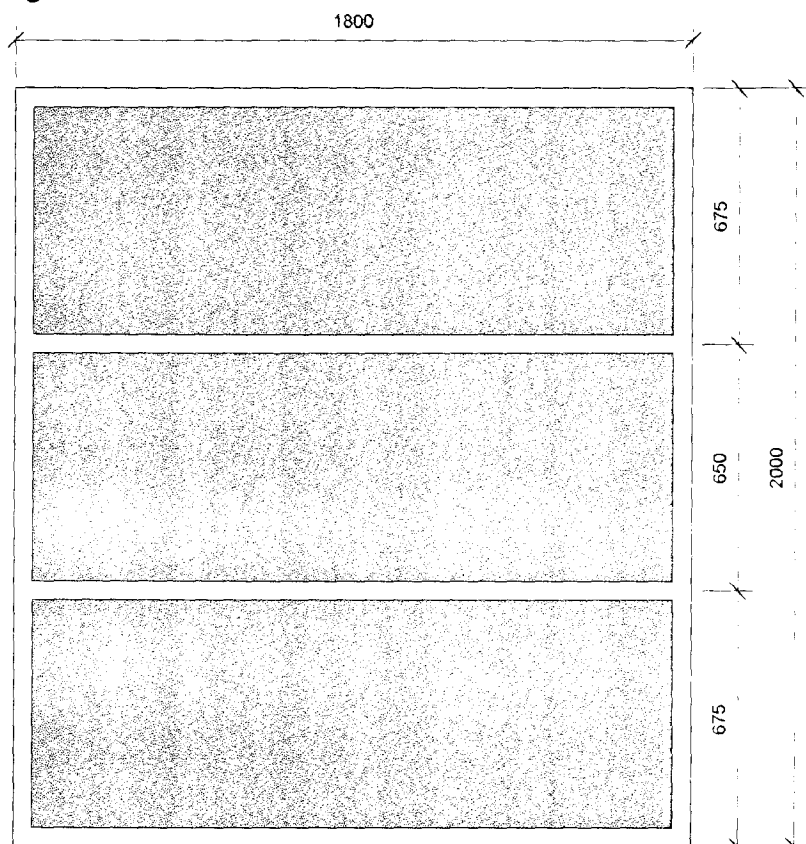

G-8, 1 stk. Gangur.
Efri brún 2200 mm frá gólfi stofu.

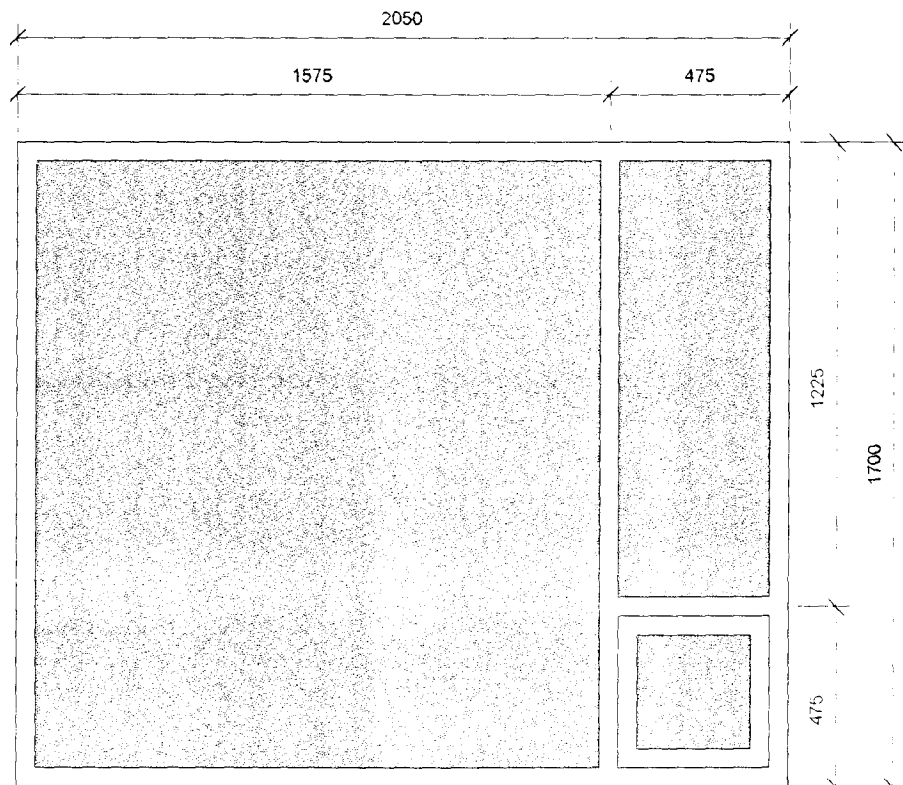

G-4, 1 stk. Eldh.
Efri brún 2500 mm frá gólfi.

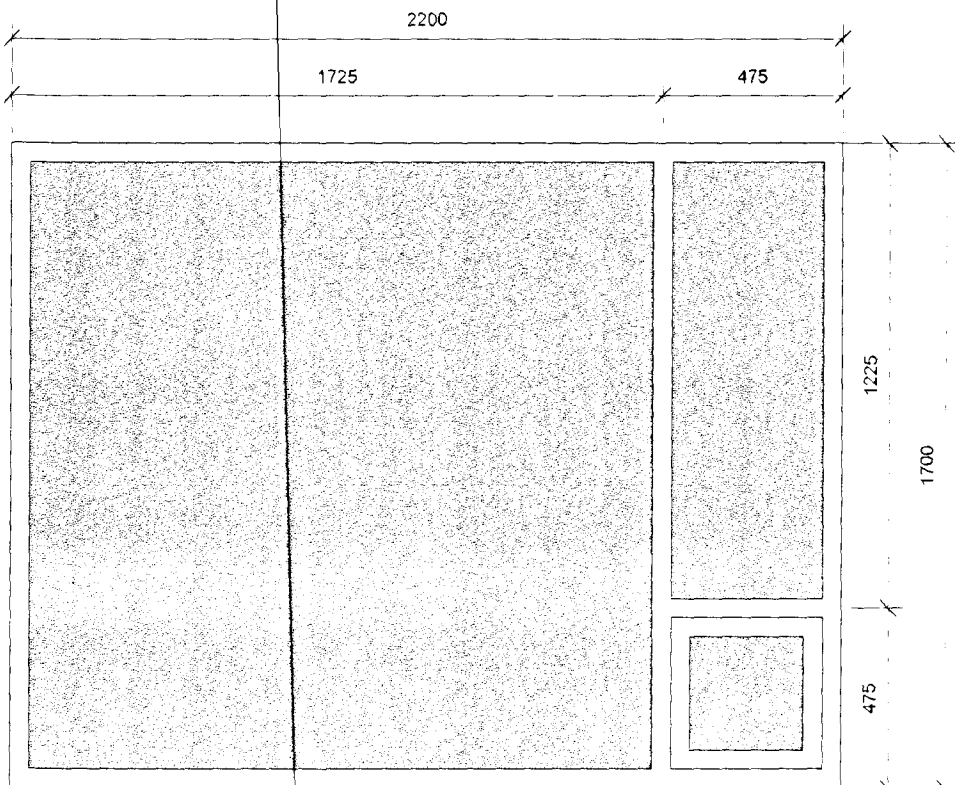

G-5, 1 stk. Stofa.
Efri brún 2500 mm frá gólfi.

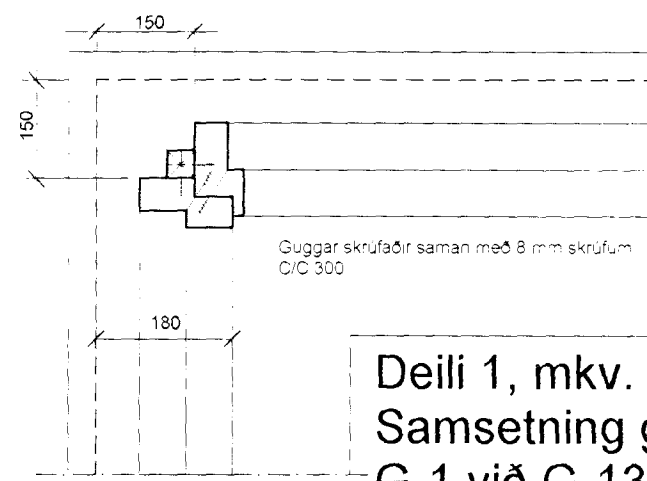

Séruppdrættir vegna Gauksás 63
Dagsetning aðaluppdráttá 23.08. 2000

- * Öll mál athugist á staðnum
- * Mælið ekki af teikningunni
- * Misræmi milli teikninga tilkynnist arkitektum

TEIKNISTOFA
Gunnlaugs Jónssonar
Ingólfsstræti 8
101 Reykjavík s: 562 1695 f: 562 1655

Verk: Gauksás 63

Teikning: Glugga samþykkt þann

Unnið fyrir: Stefán Jónsson og Björgvinur Halmarsson
Bygginga- og húsnæðisráðgjafi
Sigrún Guðmundsdóttir

Mælikvarði: 1:20
Dagsetning: 08.09.2000
Teiknað: G.J.S.AS.Þ.E.
Teikning nr.: 0019-2001

Breytingar:

Gunnlaugur Jónsson arkitekt FAI, 090462 2299