

JÄRNBENT STEYPA

Forsteyptar loftaplötur (filegran), 3. hæð

Yfirlitsmynd 1:50

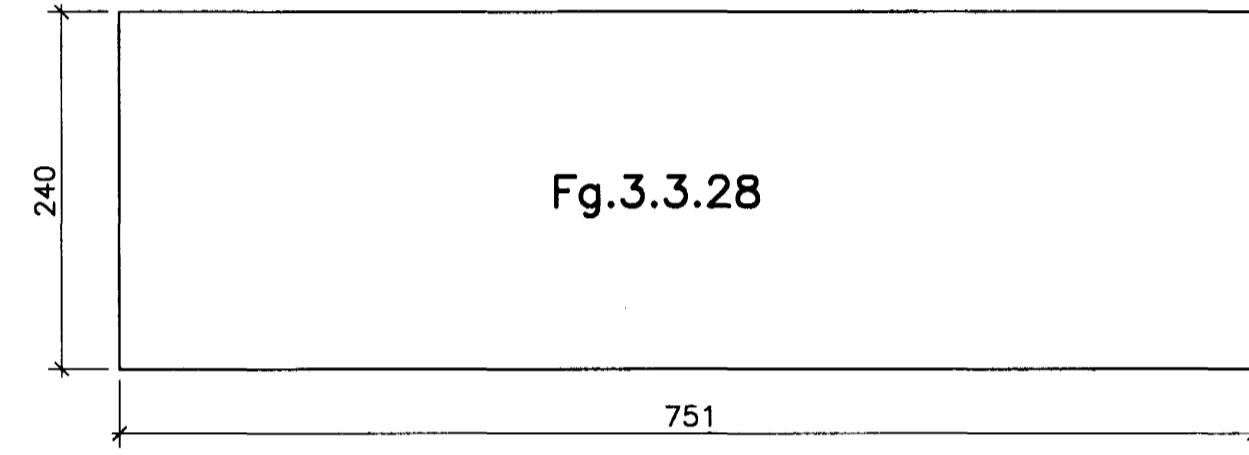
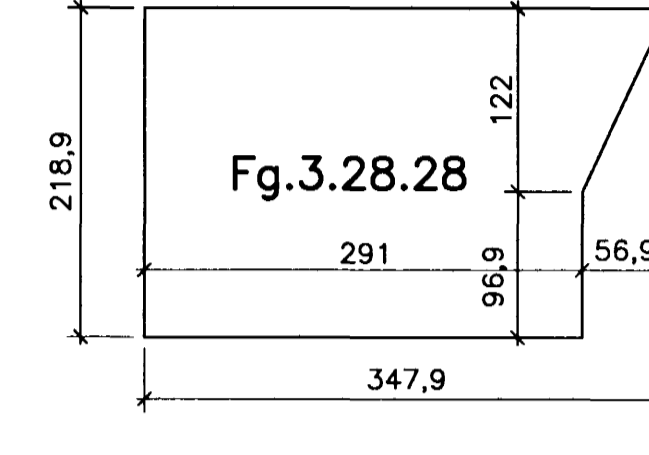
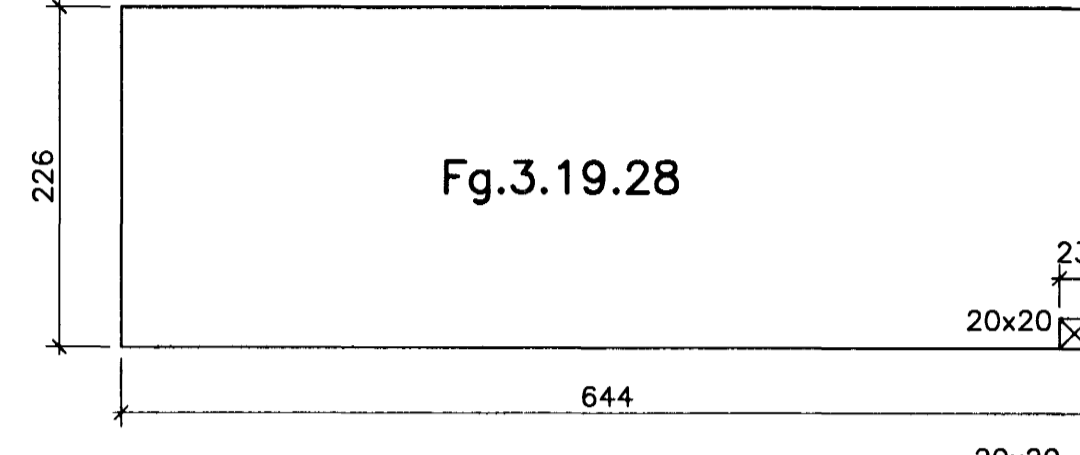
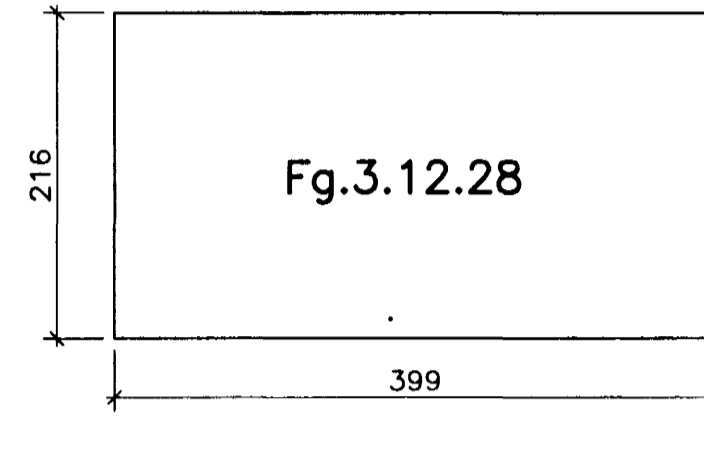
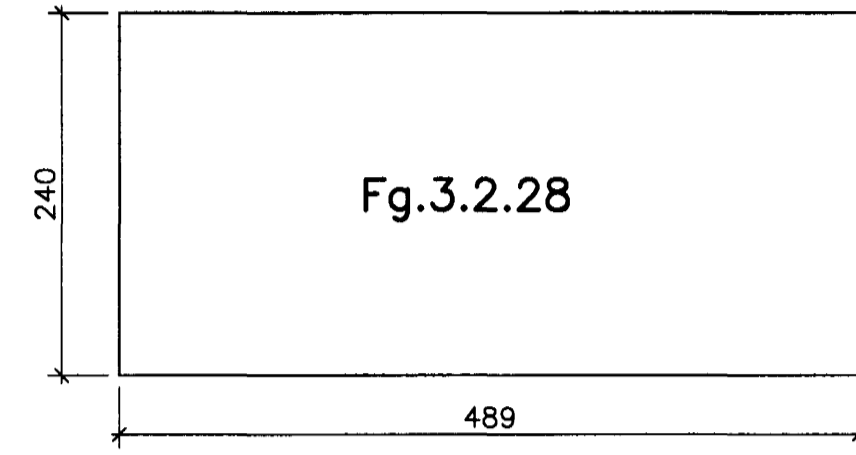
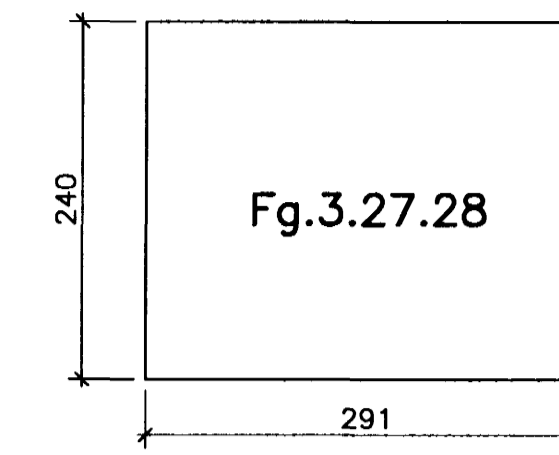
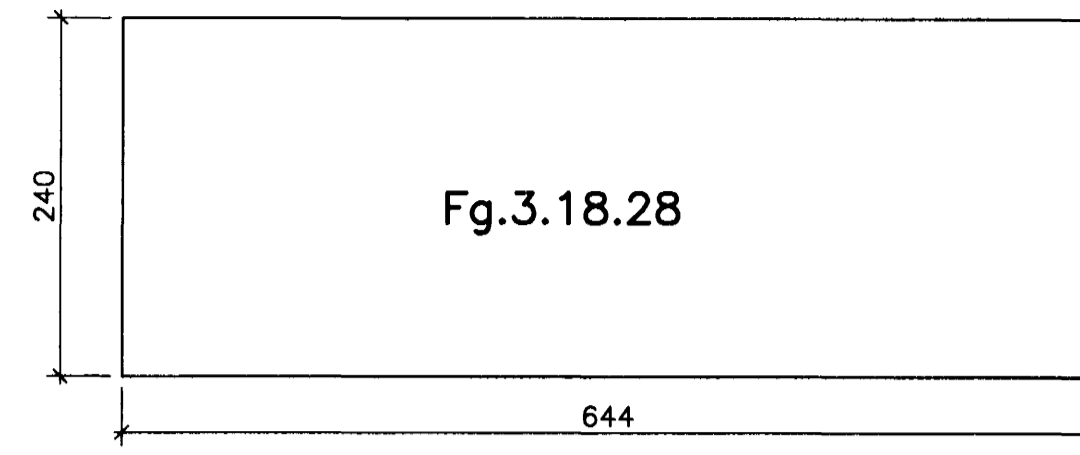
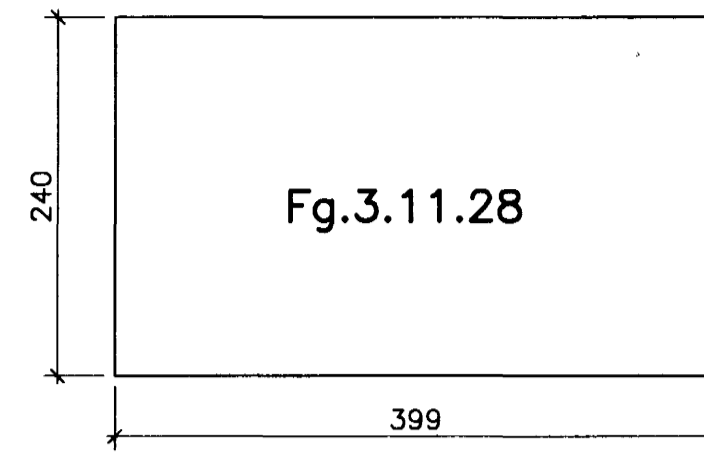
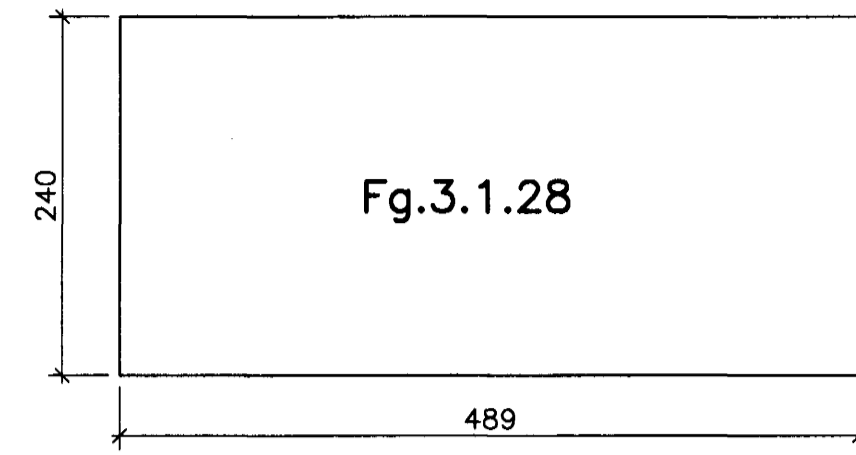

SKÝRINGAR:

Allar loftaplötur eru forsteyptar og forspennar 8 cm þykkar filegranplötur. Tengistigar (filegran-tráger) eru 14 cm háir með 90 cm bili. Forspennukaplar eru spennir 1 1050 MPa og eru með 30 cm millibili. Sérmynd, sjá bl. 77.

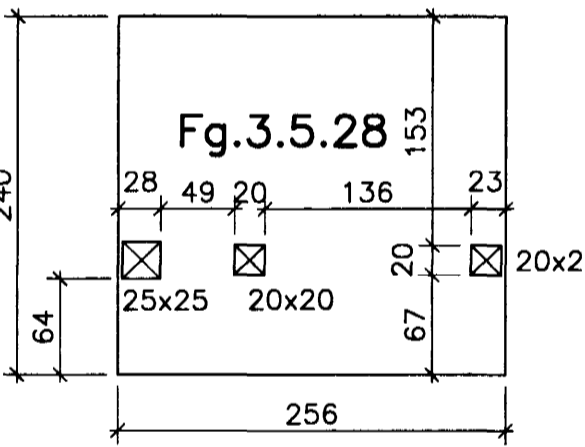
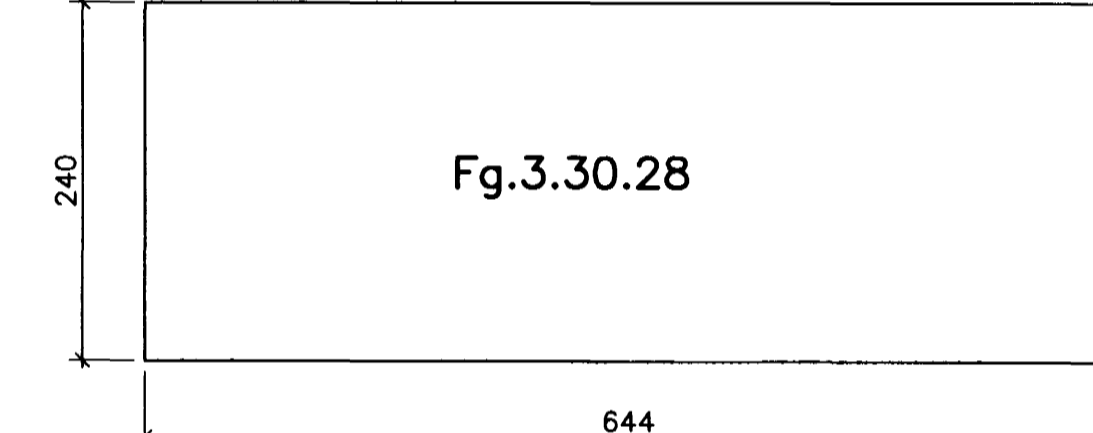
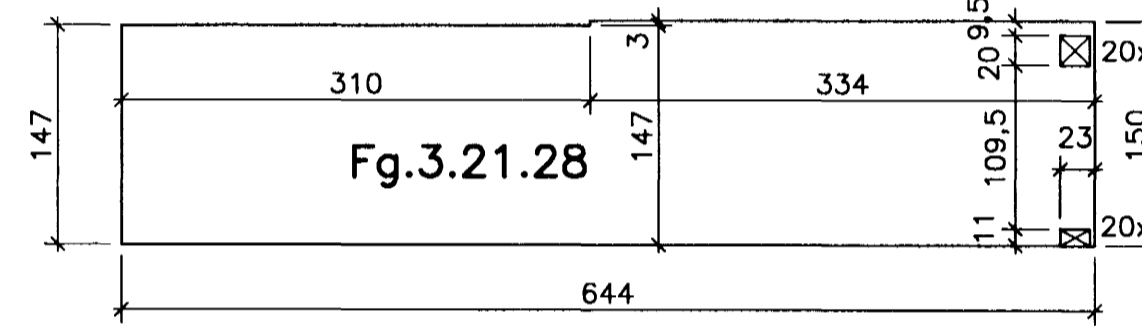
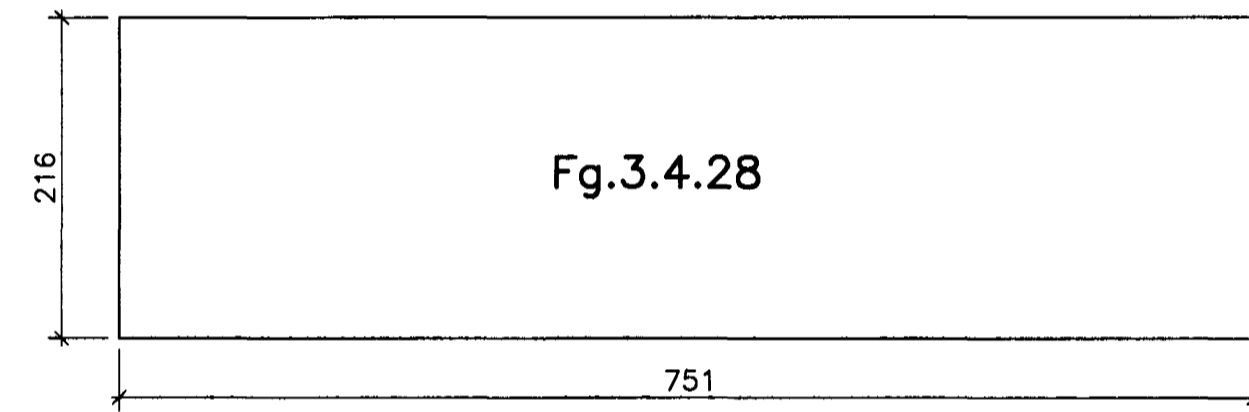
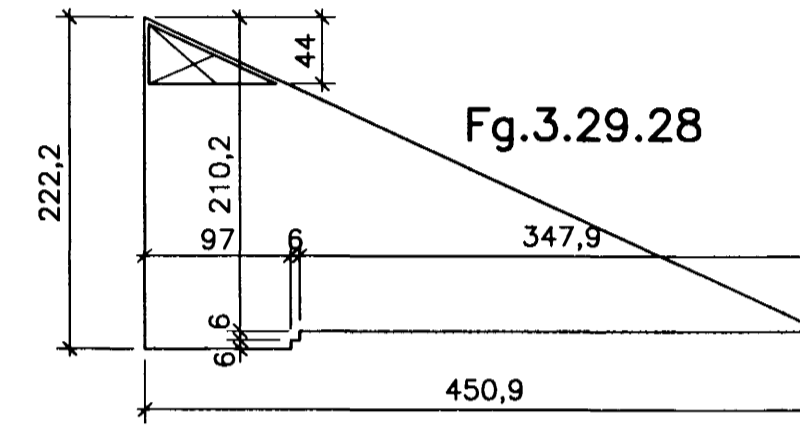
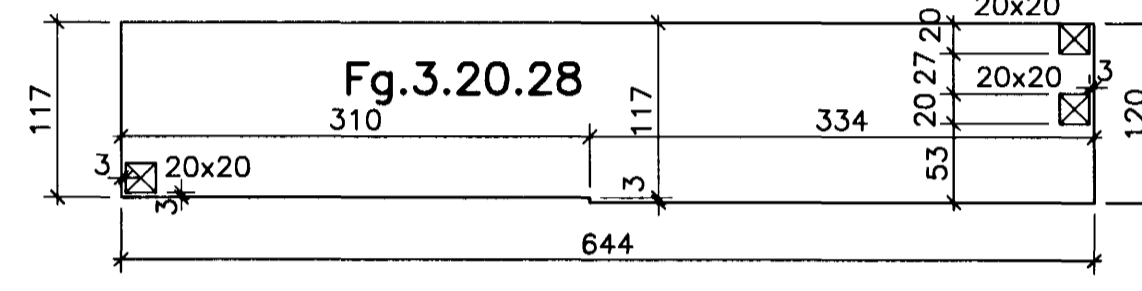

Fg.3.7.28 ekki til

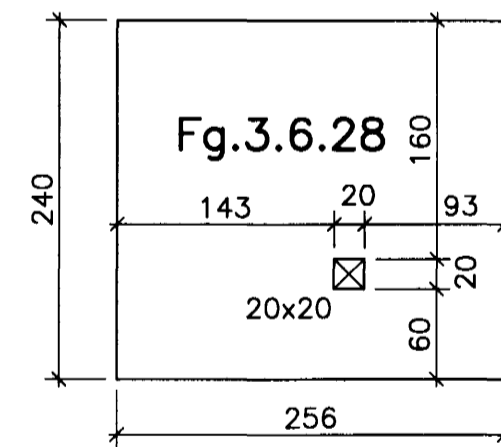
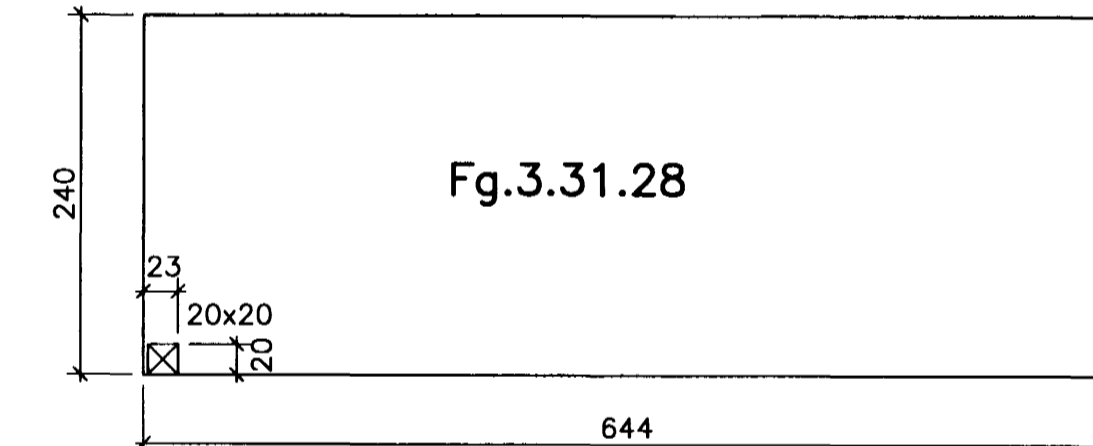
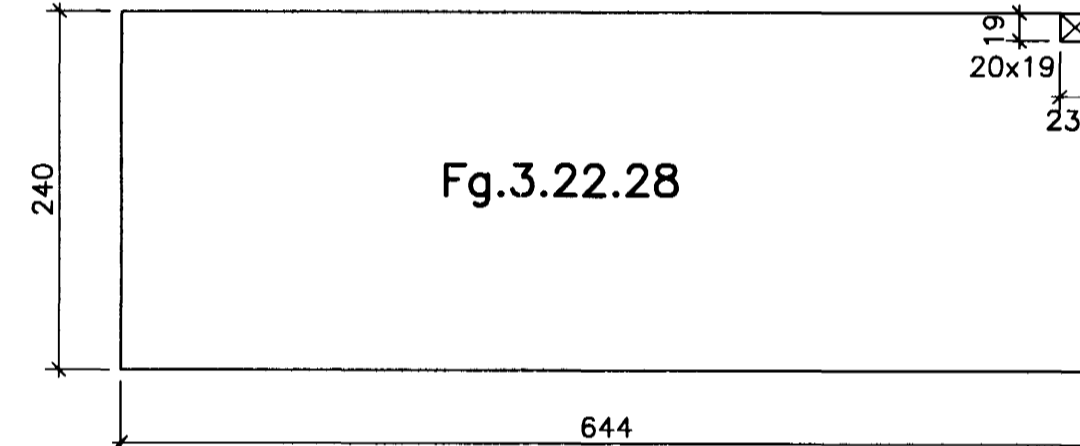
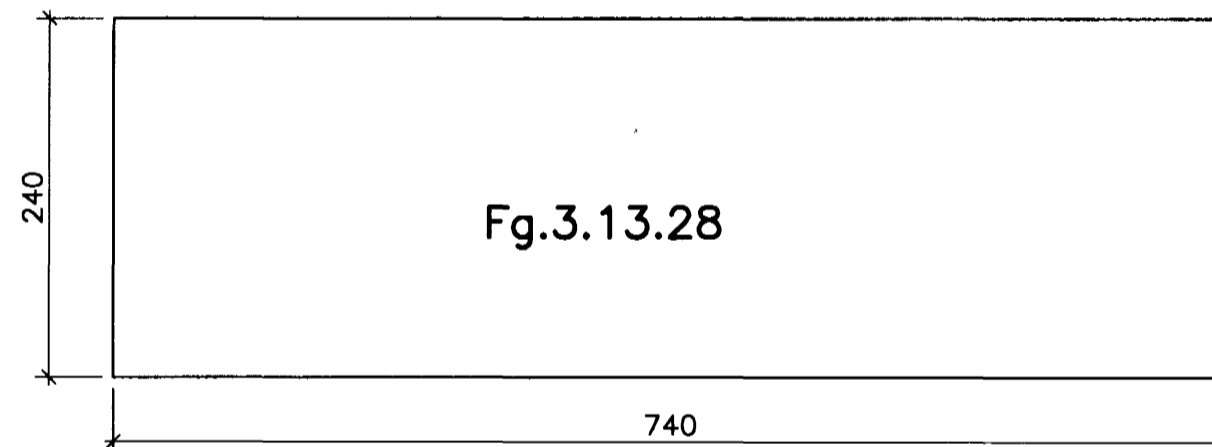

Fg.3.8.28 ekki til

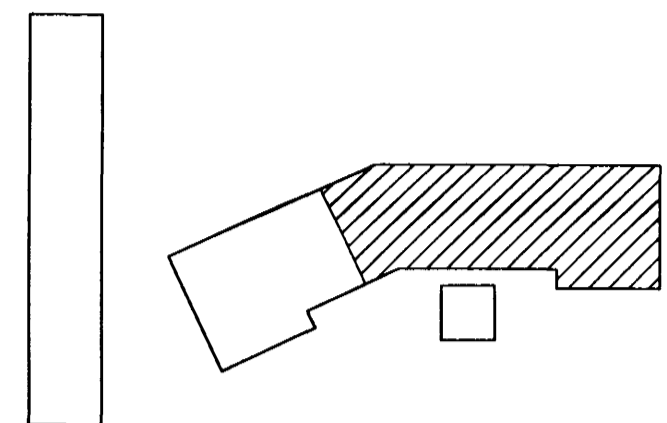
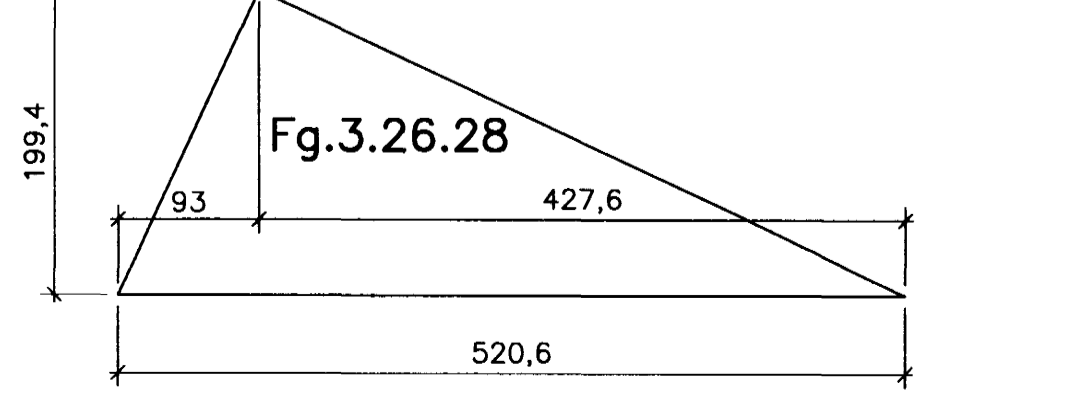
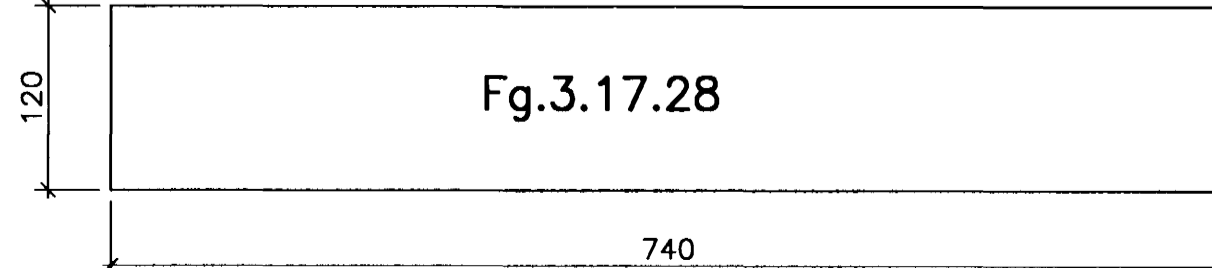
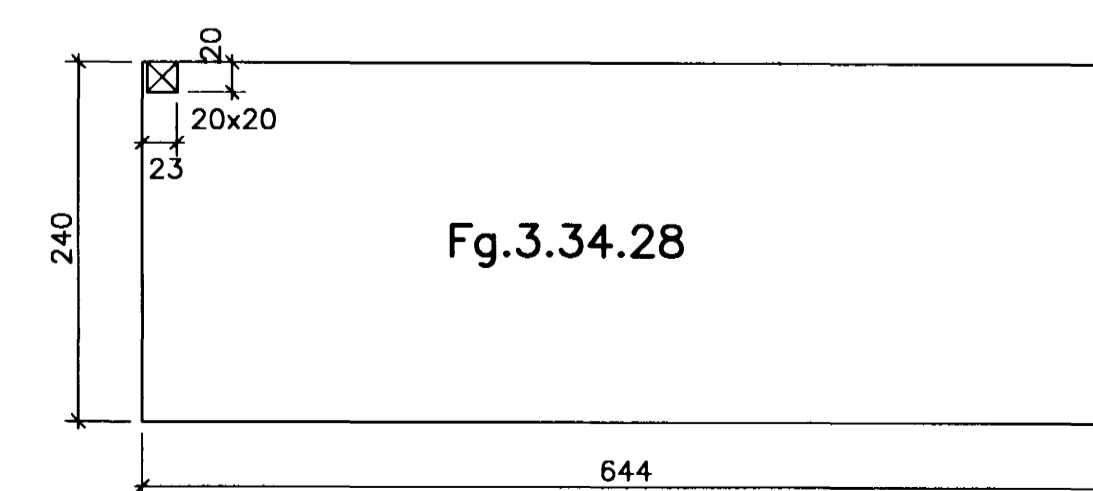
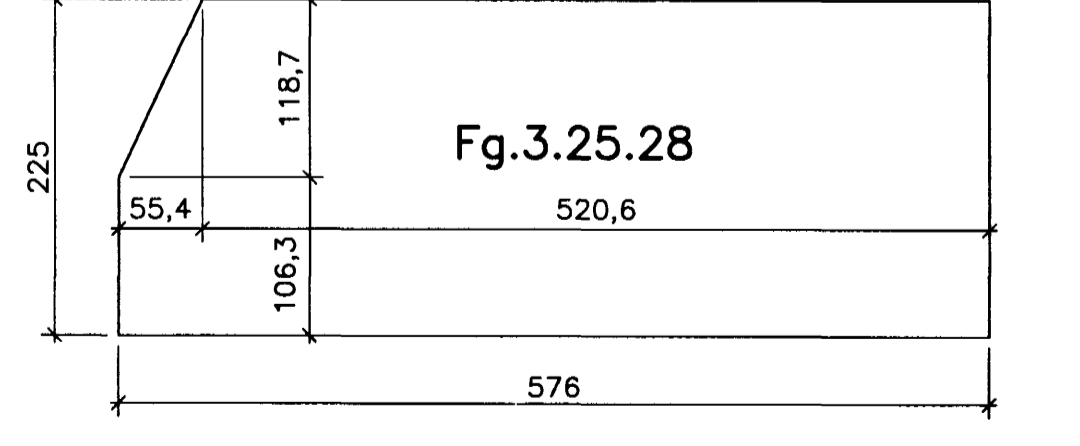
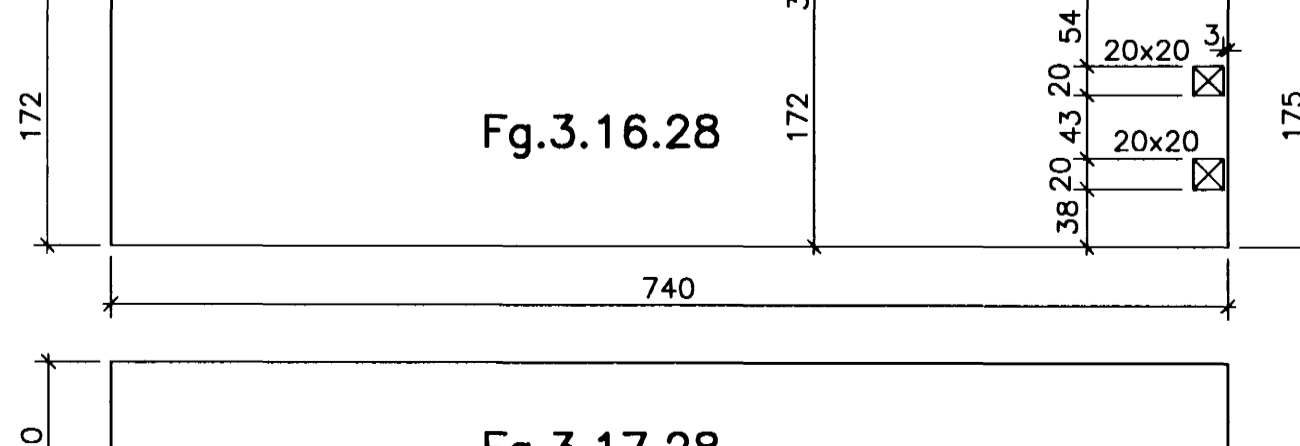
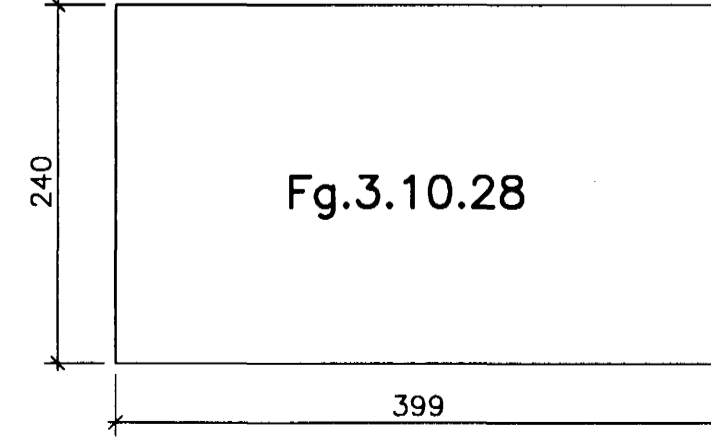
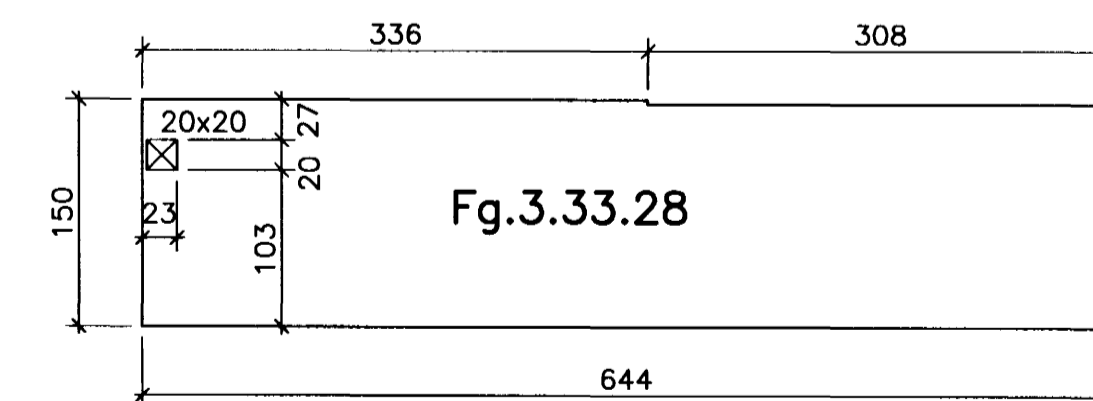
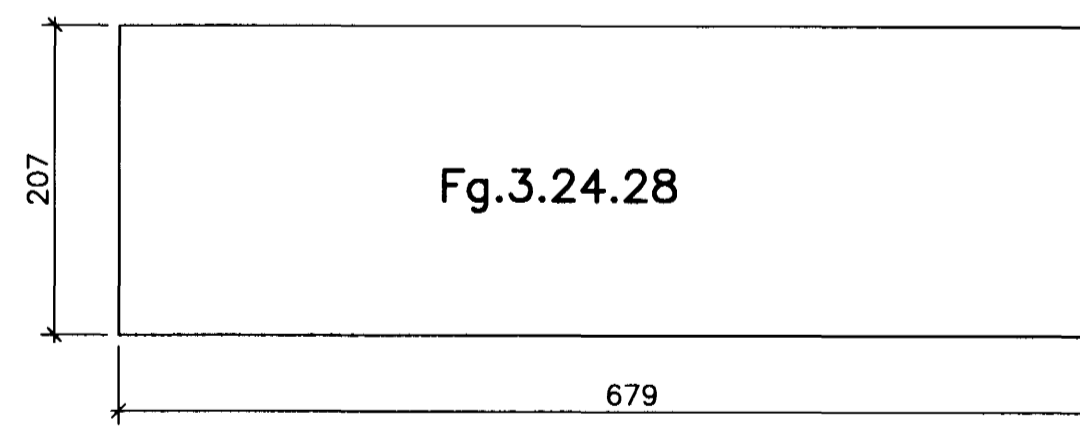
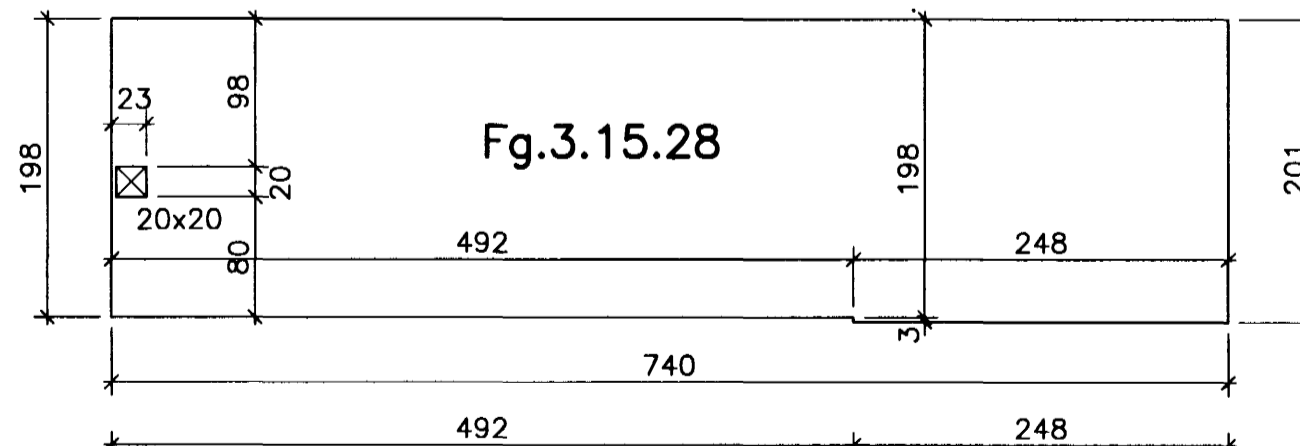
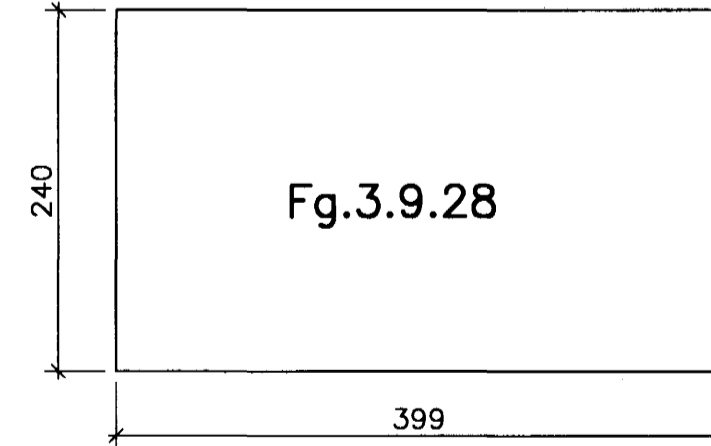
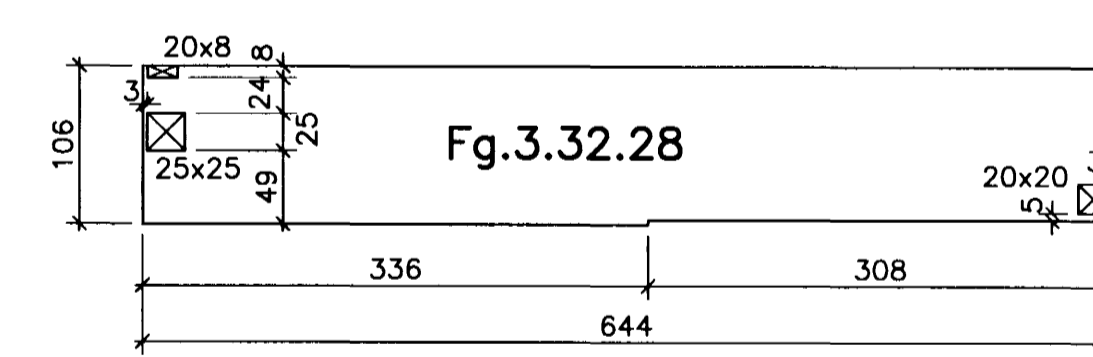
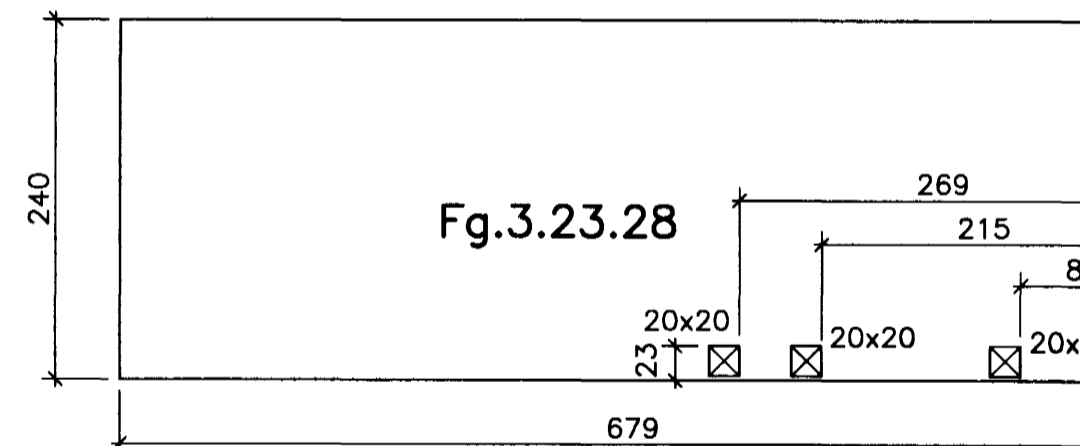
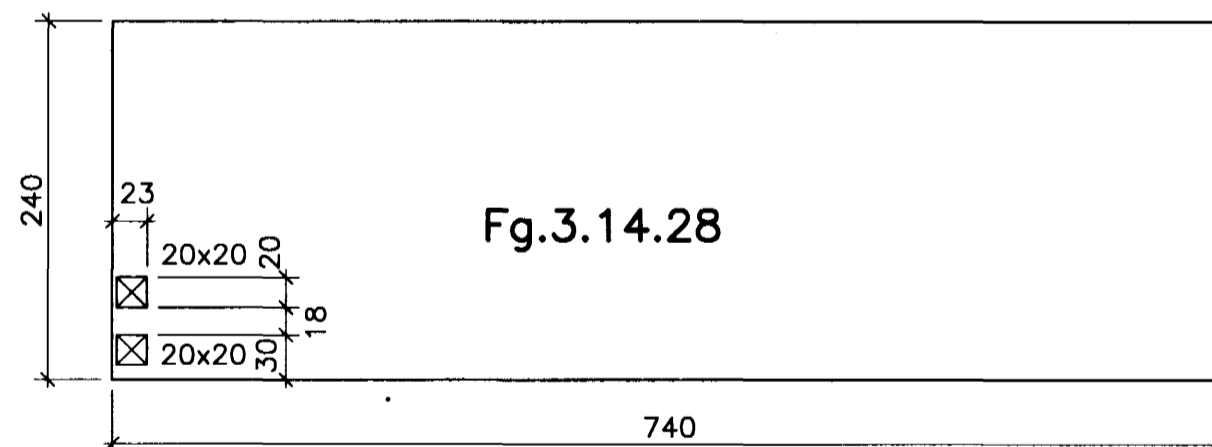

Breytingar:

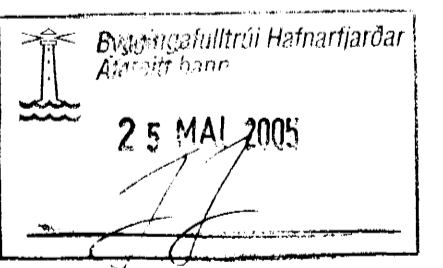

TEIKNISTOFAN
ÓDINSTORGI

Verkefni: Lækjargata 28 Hafnarfirði
 Heiti: Järnbent steypa: Forsteyptar loftaplötur (filegranplötur)
 Hönnun: Vífill Oddsson verkfræðingur
 VÍFILL ODDSSON VERKFRÆÐINGUR
 kt. 101237-3629 FVFI - FRV
 ÓDINGSGÖTU 7 REYKJAVÍK SIMI: 510-2200
 M. 1:50 FAX: 510-2201
 R. V.O./K.S.G.
 T. K.S.G.
 Dags. apríl 2005 Nr. 968-1-76