

# JÄRNBENT STEYPA

## Forsteyptar loftaplötur (filegran)

### Yfirlitsmynd 1:50

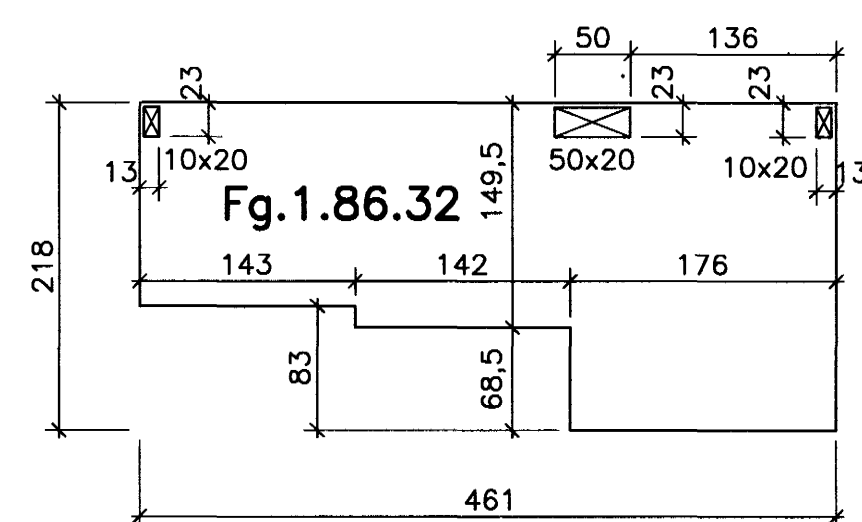
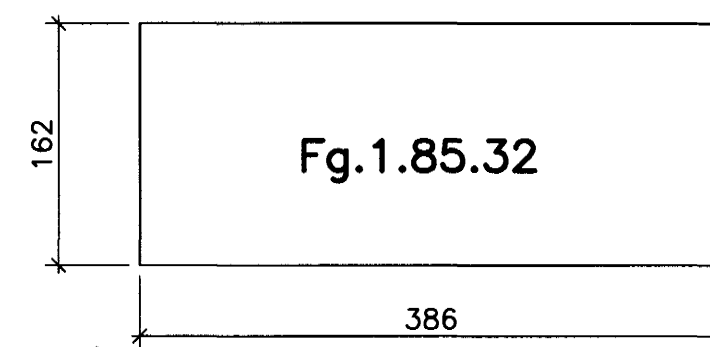
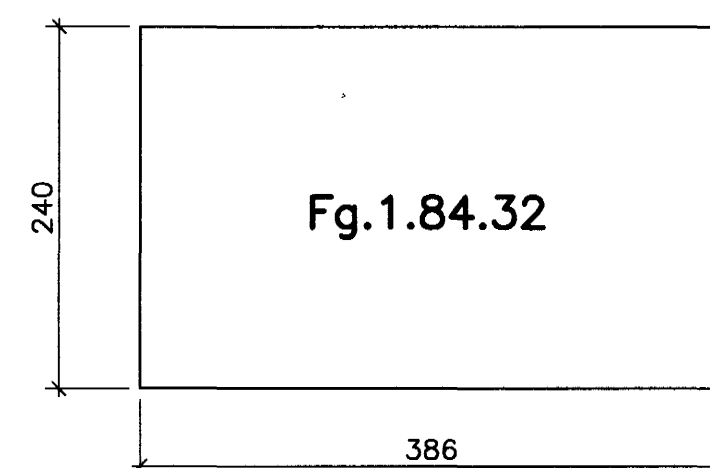
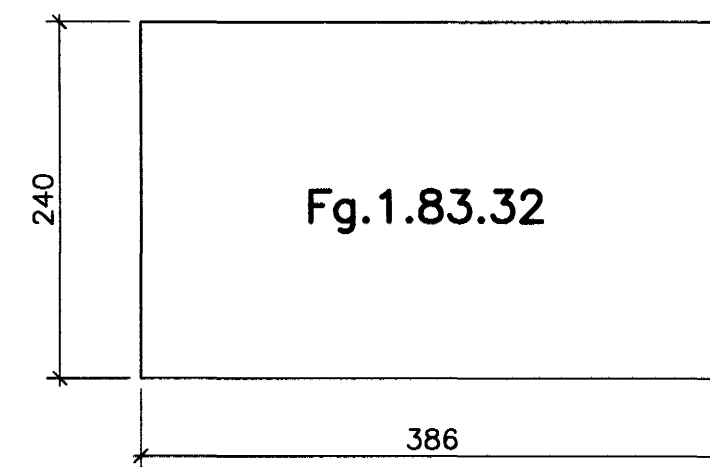
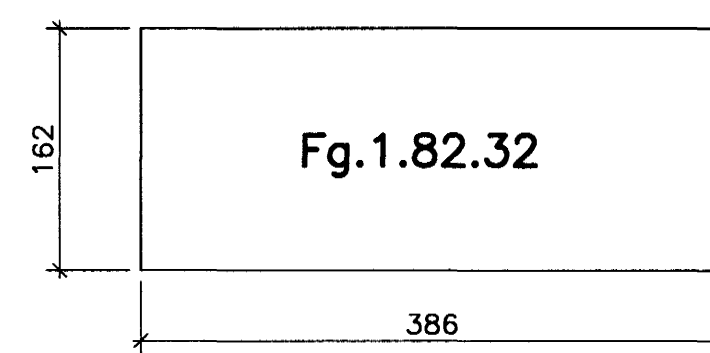
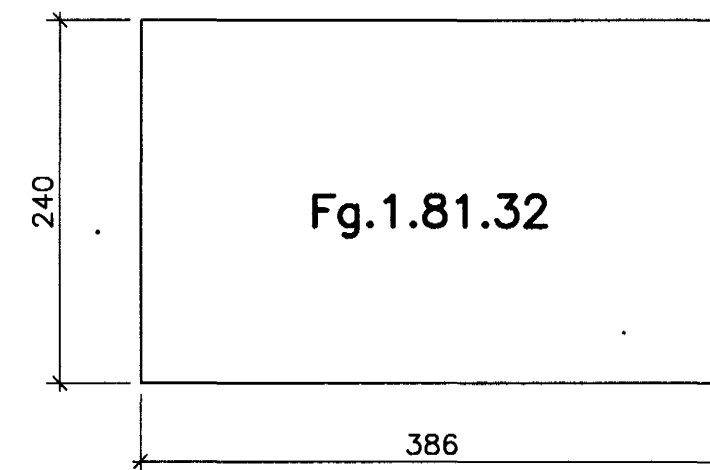
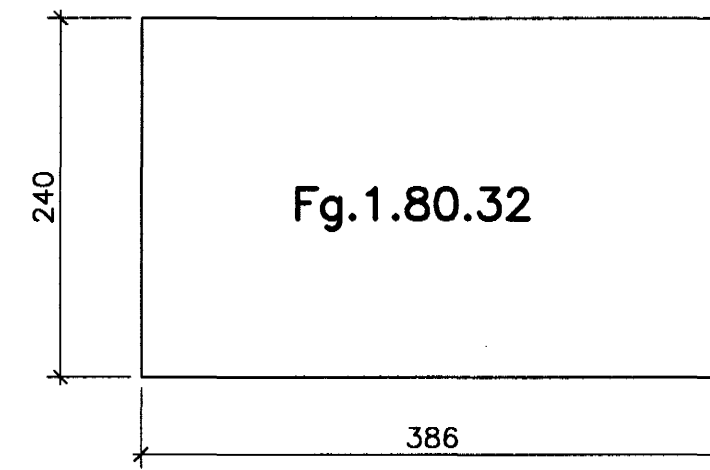
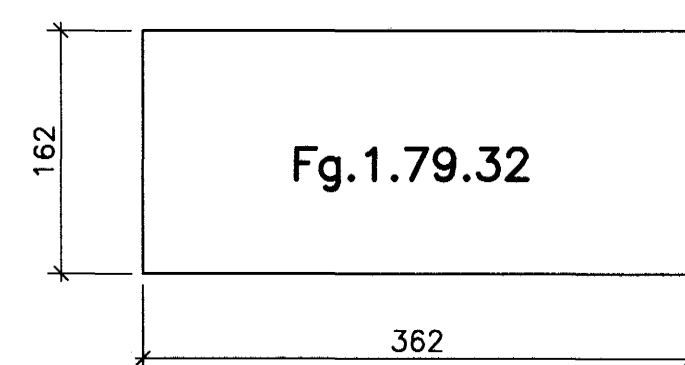
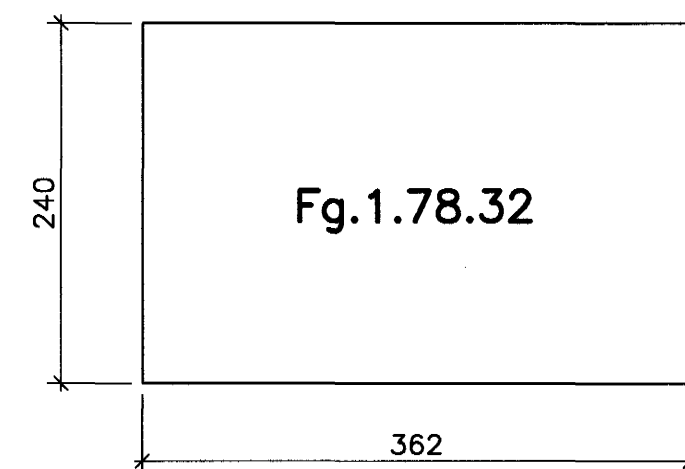
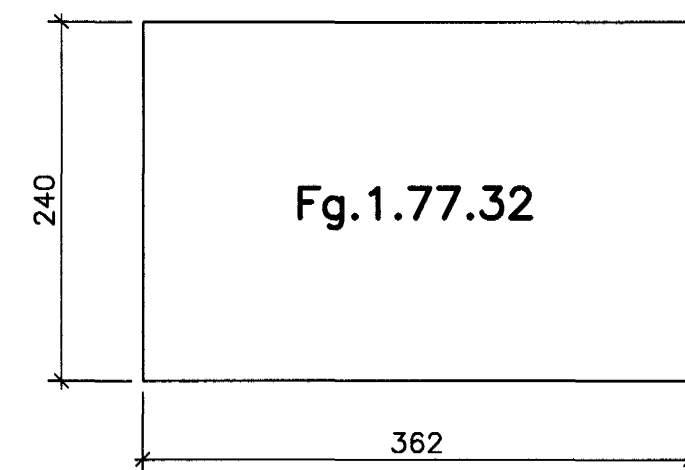
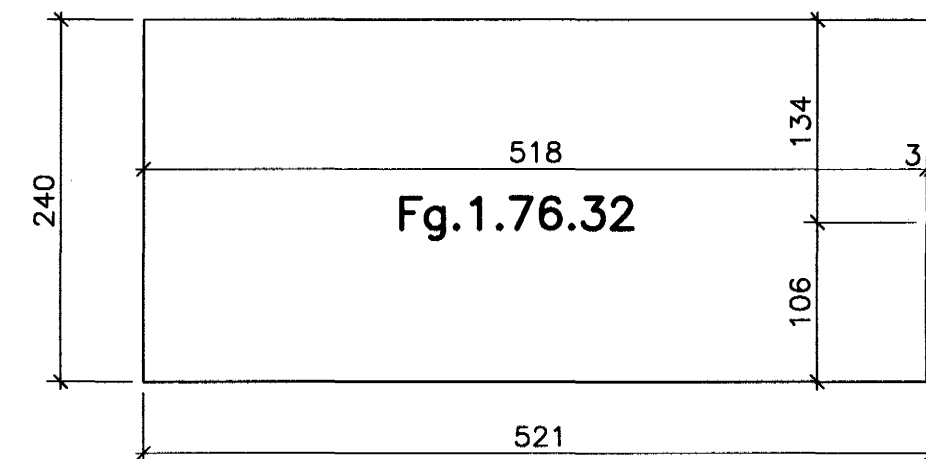
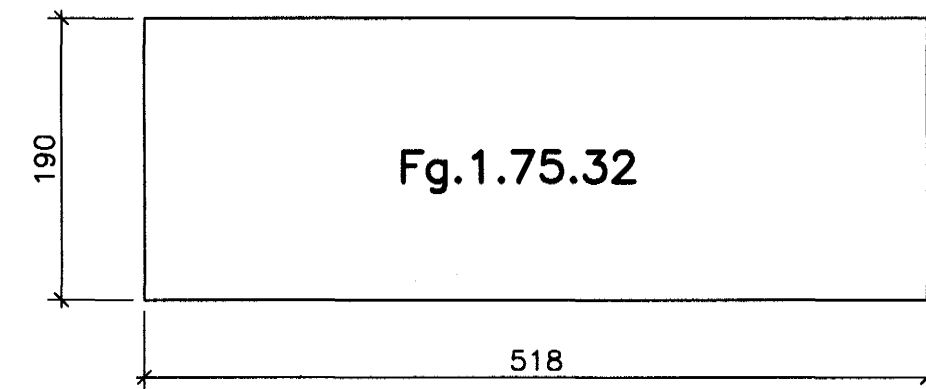
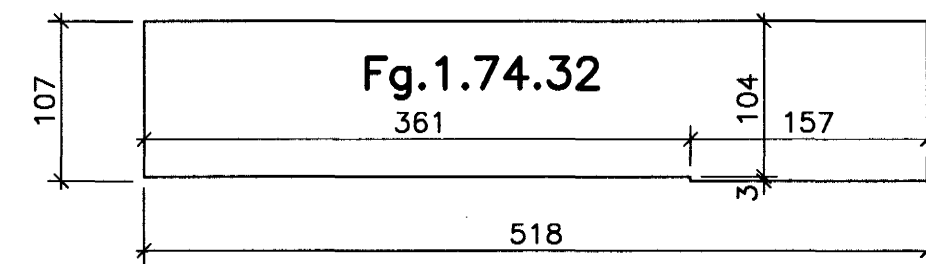
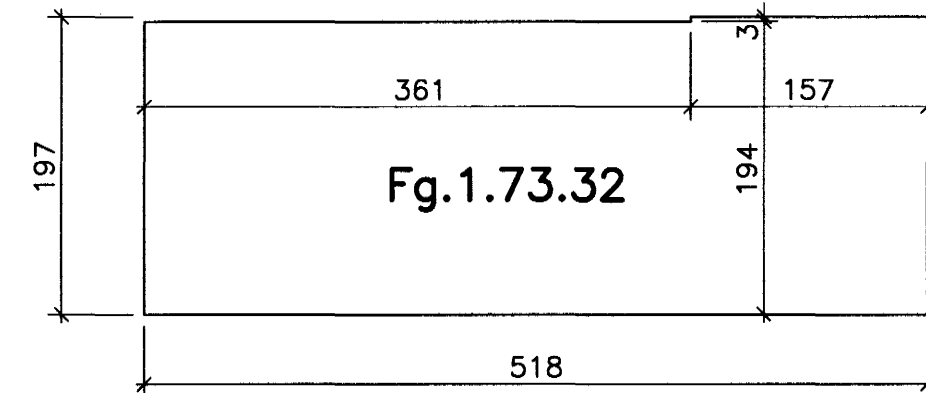
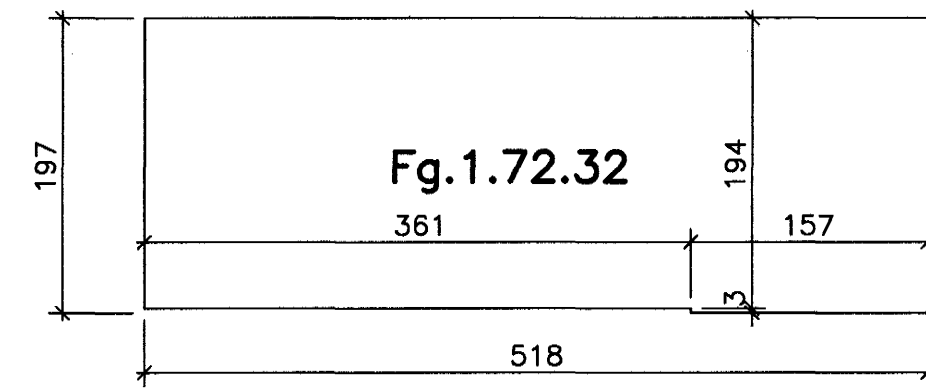

#### SKÝRINGAR:

Allar loftaplötur eru forsteyptar og forspenntar 8 cm bykkar filegranplötur. Tengistigar (filegran-trager) eru 14 cm háir með 90 cm bili. Forspennukaplar eru spennir í 1050 MPa og eru með 30 cm millibili.

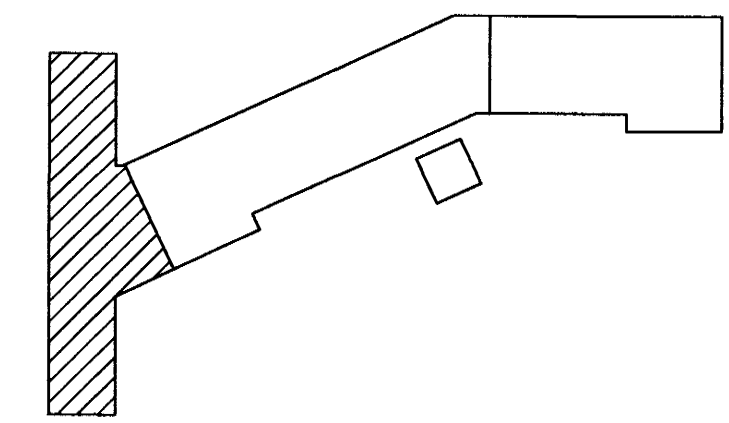

Breytingar:

#### Kennisnið í filegranplötur 1:20

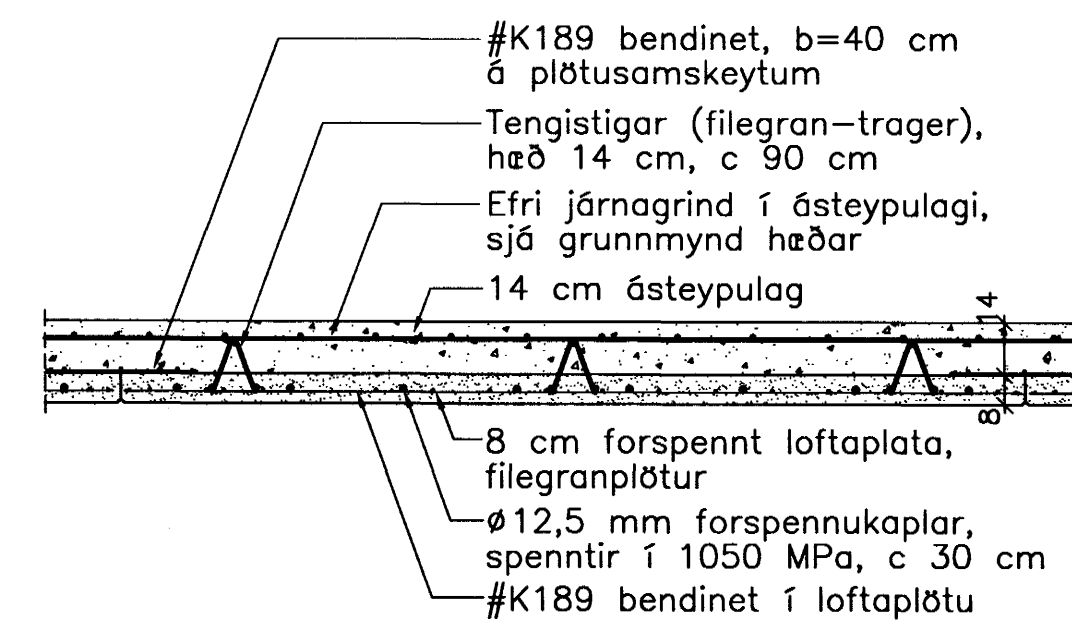

TEIKNISTOFAN ÖDINSTORGI  
 Samþykkt þann 30 MAÍ 2005  
 Byggingafræðingur í Hafnarfirði  
 E.O. Sigurbjartur Halldórsson

Verkefni: Lækjargata 32 Hafnarfirði

Heiti: Järnbent steypa: Forsteyptar loftaplötur (filegranplötur)

Hönnun: Vífill Oddsson verkfræðingur  
 V.O.

VÍFILL ODDSSON VERKFRÆÐINGUR  
 kt. 101237-3629 FVFI - FRV  
 ÖDINGÖTU 7 REYKJAVÍK SIM: 510-2200  
 FAX: 510-2201

M. 1:50 og 1:20  
 R. V.O./K.S.G.  
 T. K.S.G.  
 Dags. okt. 2004 Nr. 970-1-12