

1 SNID
201202 M. 1:20

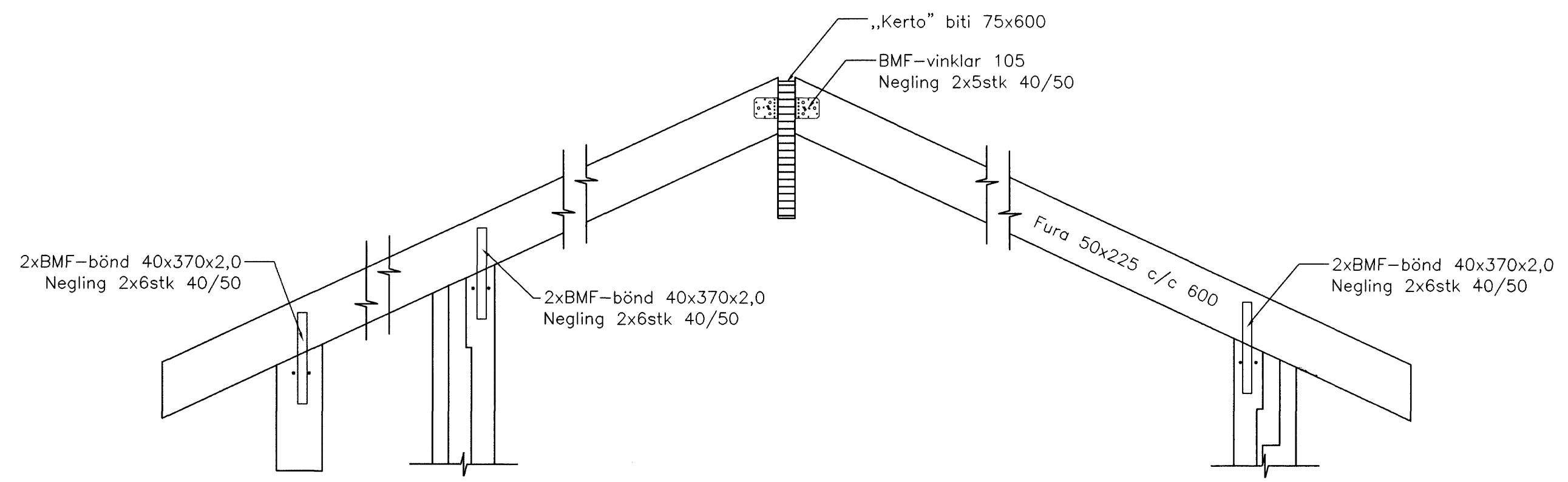

2 SNID
201202 M. 1:20

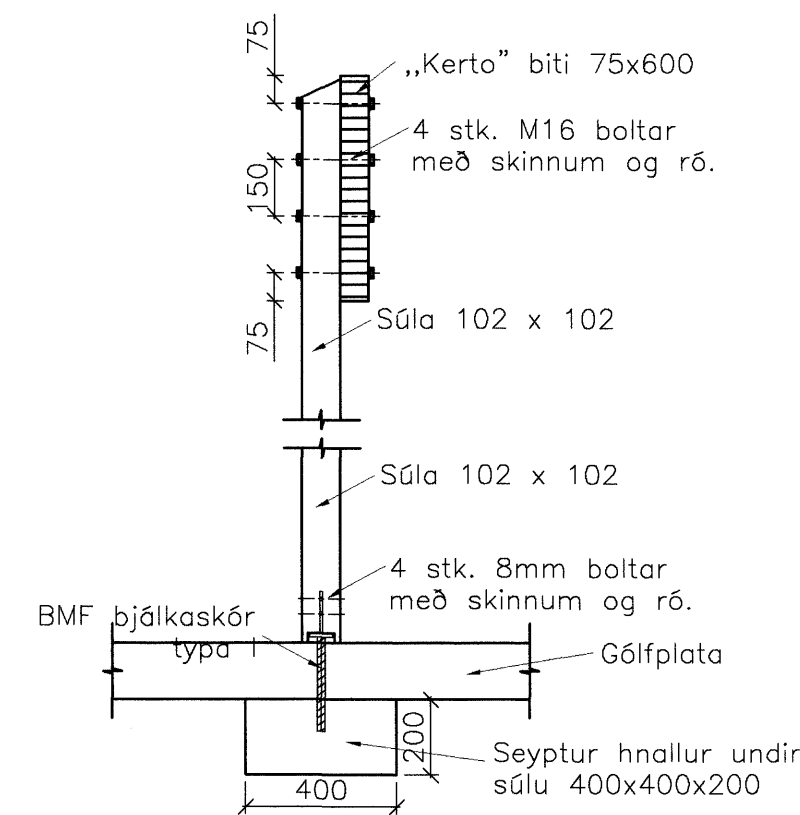

3 SNID
201202 M. 1:20

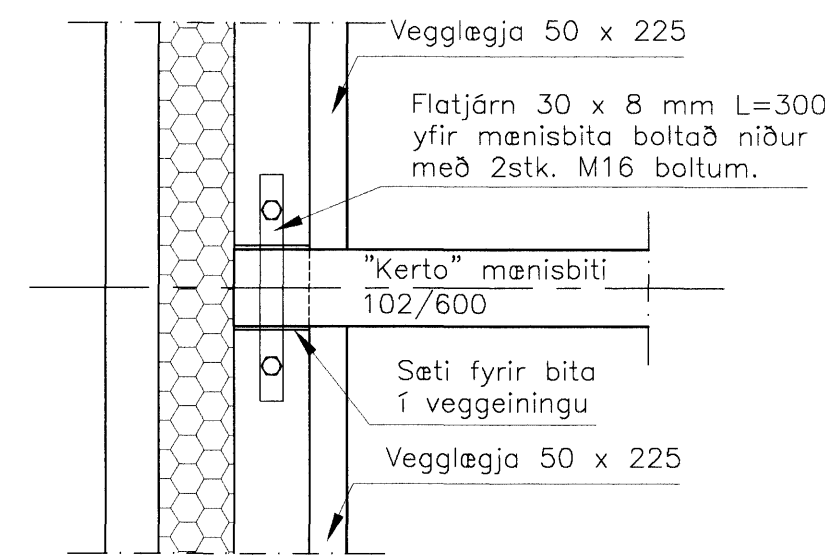

A FESTING MÆNISBITA
201202 M. 1:10

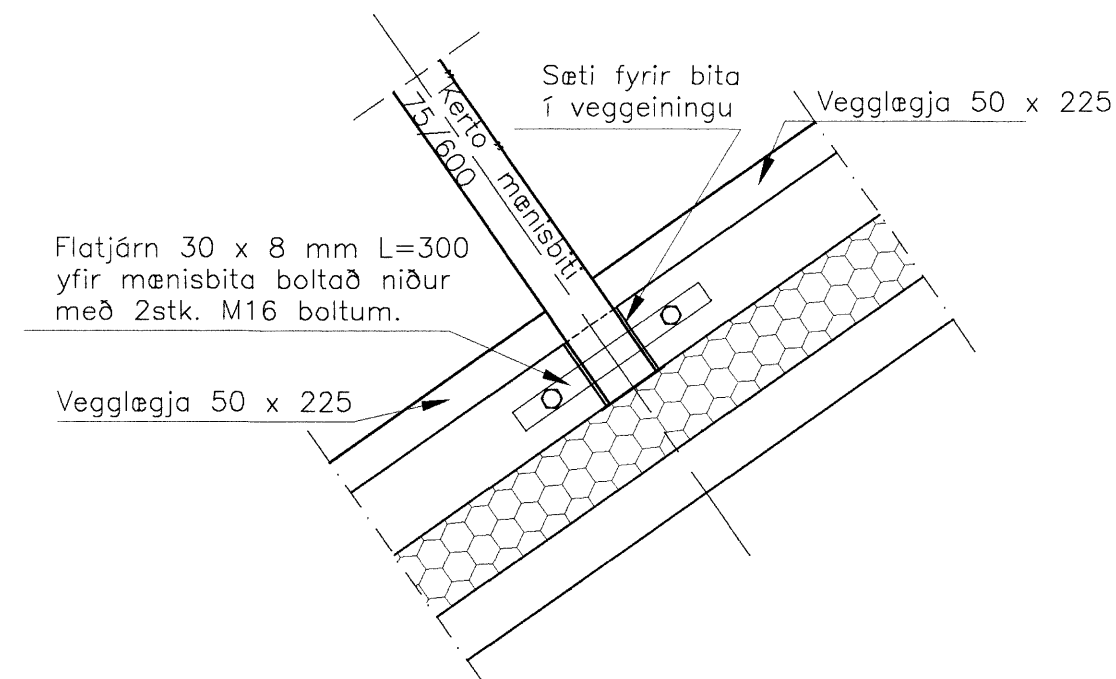

D FESTING MÆNISBITA
201202 M. 1:10

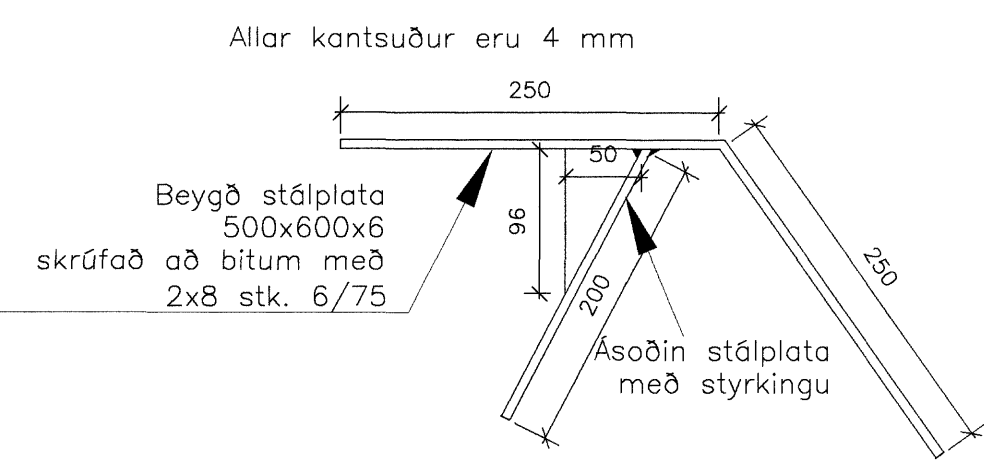

Sérmynd 1
Stáiplata mkv. 1:5

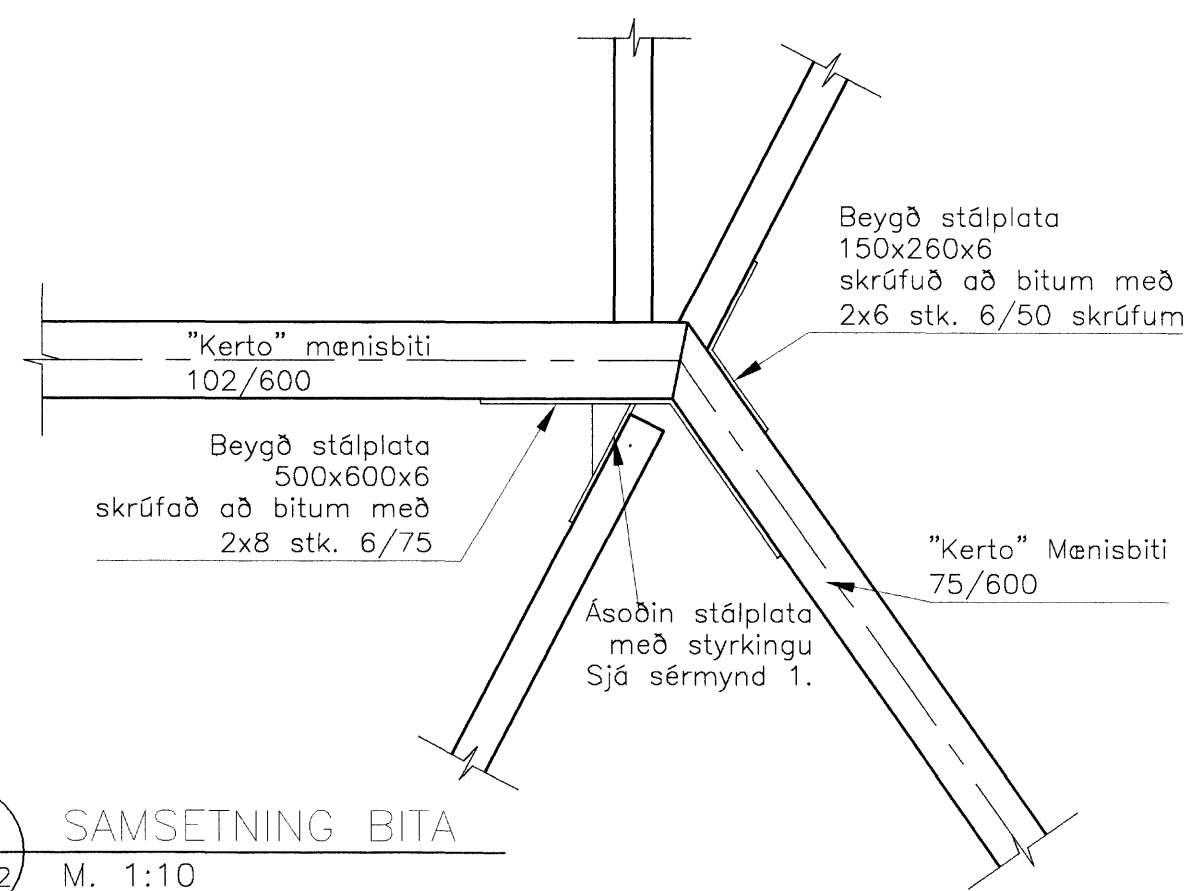

B SAMSETNING BITA
201202 M. 1:10

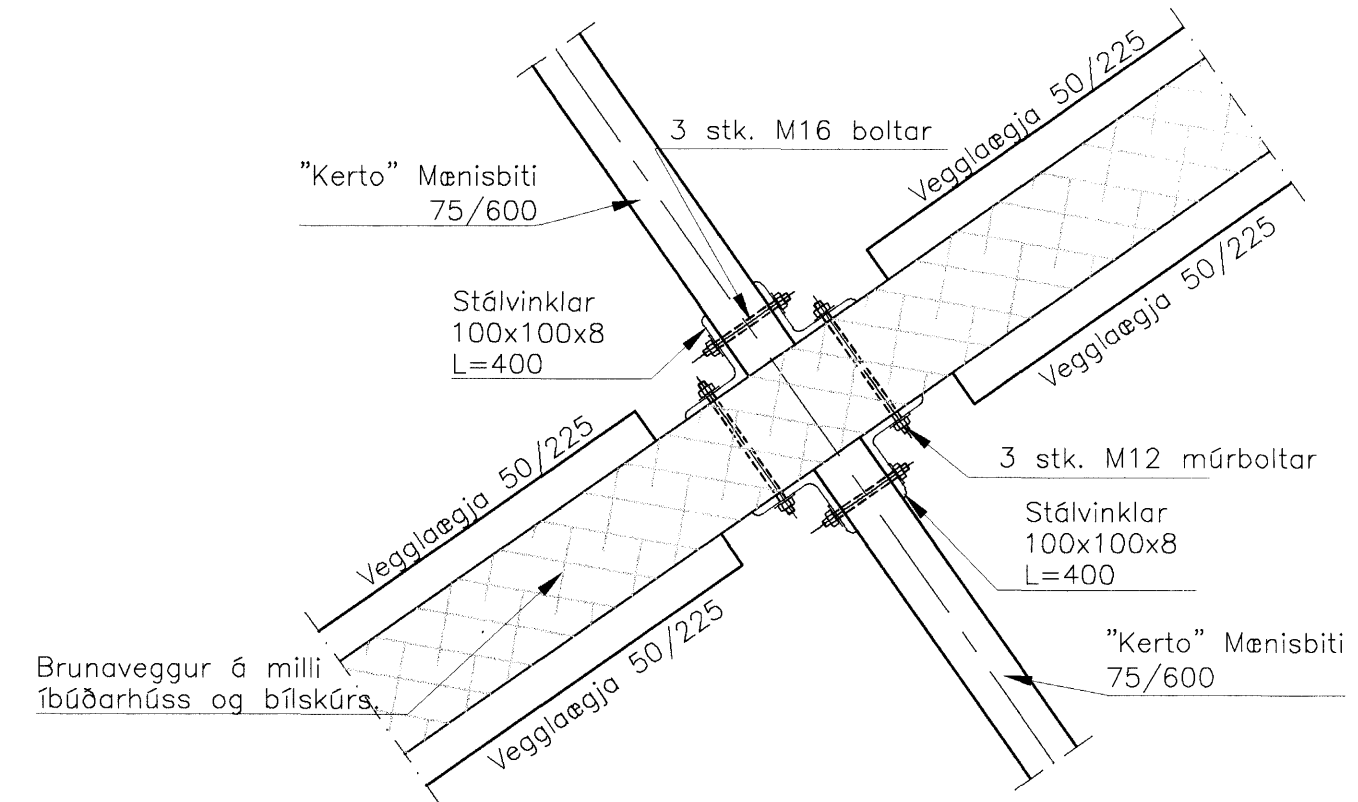

C FESTING BITA VID VEGG
201202 M. 1:10

Ártilur samræmingarhönnuðar

Br.	Dags.	Eðli breytingar	Hannað	Althugab
Samp.				Kt.

Samþykkt þann 21 MARS 2005
Byggingafultrúinn í Hafnarfirði
F.h. Sigurbjartur Halldórsson

Lýkilmýnd

Almenna verkfræðistofan
Suðurgötu 57 - 300 Akranesi
S: 431 1785 - Fax: 431 3098
av@almenna.is - www.almenna.is

FURUVELLIR 24
HAFNARFIRÐI
BURÐARÞÓL ÞAKVIRKIS
SNID, SÉRMYNDIR

Hannað NT	Althugab NT	M. 1:20 / 1:10
Samp. <i>[Signature]</i>	Nr. 201202-135	
Dags. 11.02.2005	Nr. 232-B-202	

Ástundir á teikningu eru á öbyrgð Almennu verkfræðistofunnar hf. kt. 470671-0179