

Sérupprættir vegna Furuvala 12  
Dagsetning aðaluppdráttar 04.02.04

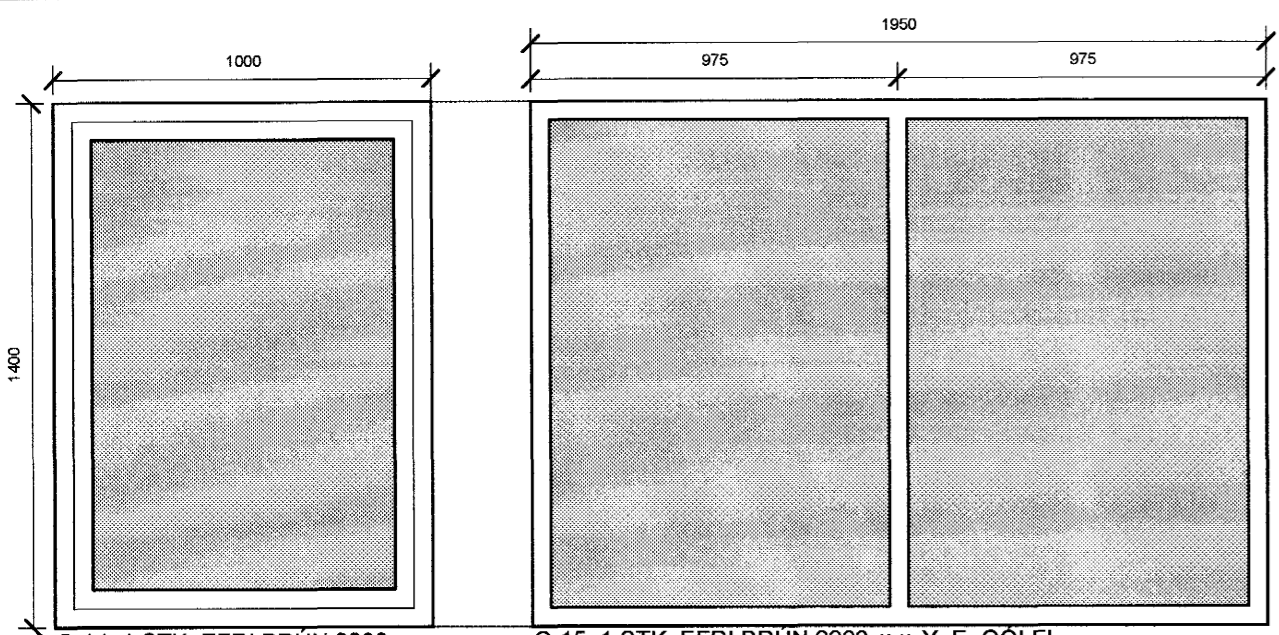

G-14, 1 STK. EFRI BRÚN 2200 mm Y. E. GÓLFI SETTUR SAMAN VIÐ G-15 SEM HORNGLUGGI

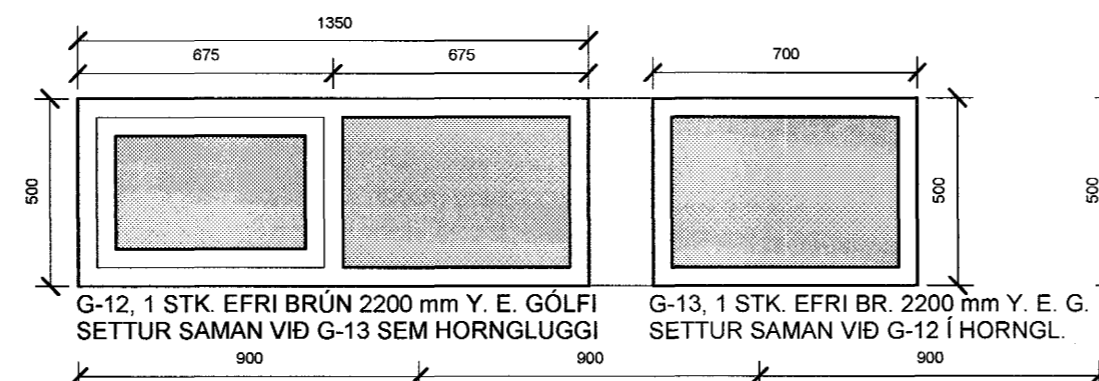

G-12, 1 STK. EFRI BRÚN 2200 mm Y. E. GÓLFI SETTUR SAMAN VIÐ G-13 SEM HORNGLUGGI

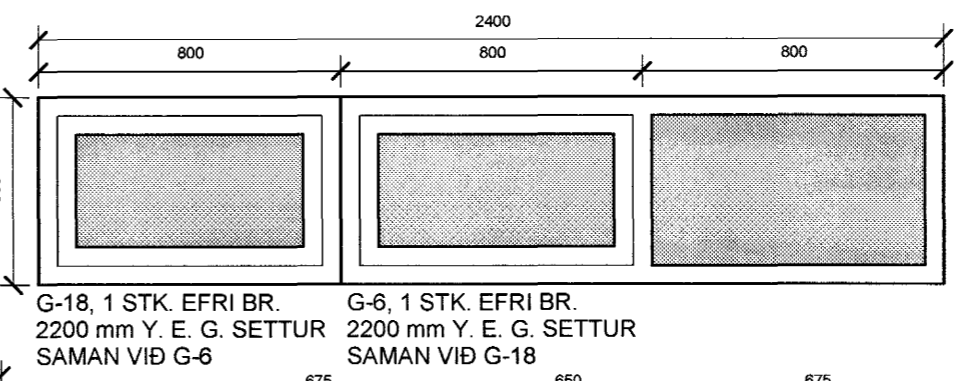

G-18, 1 STK. EFRI BR. 2200 mm Y. E. G. SETTUR SAMAN VIÐ G-6

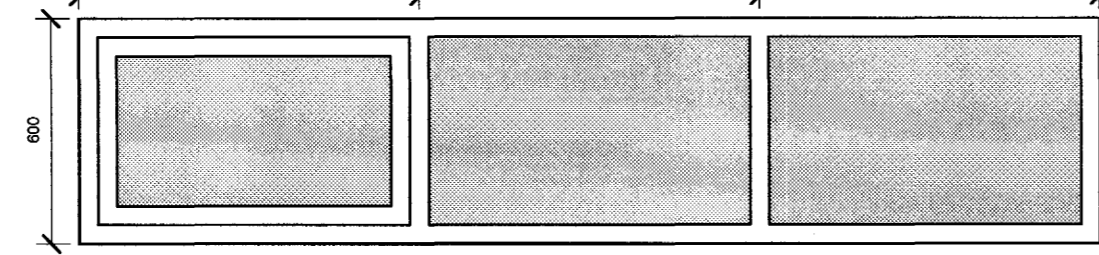

G-4, 1 STK. EFRI BR. 2200 mm YFIR ENDANLEGU GÓLFI

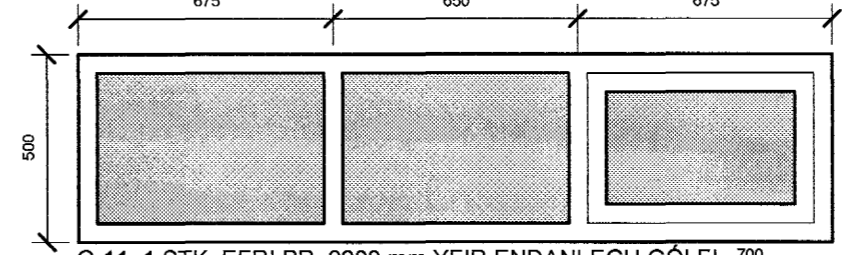

G-11, 1 STK. EFRI BR. 2200 mm YFIR ENDANLEGU GÓLFI

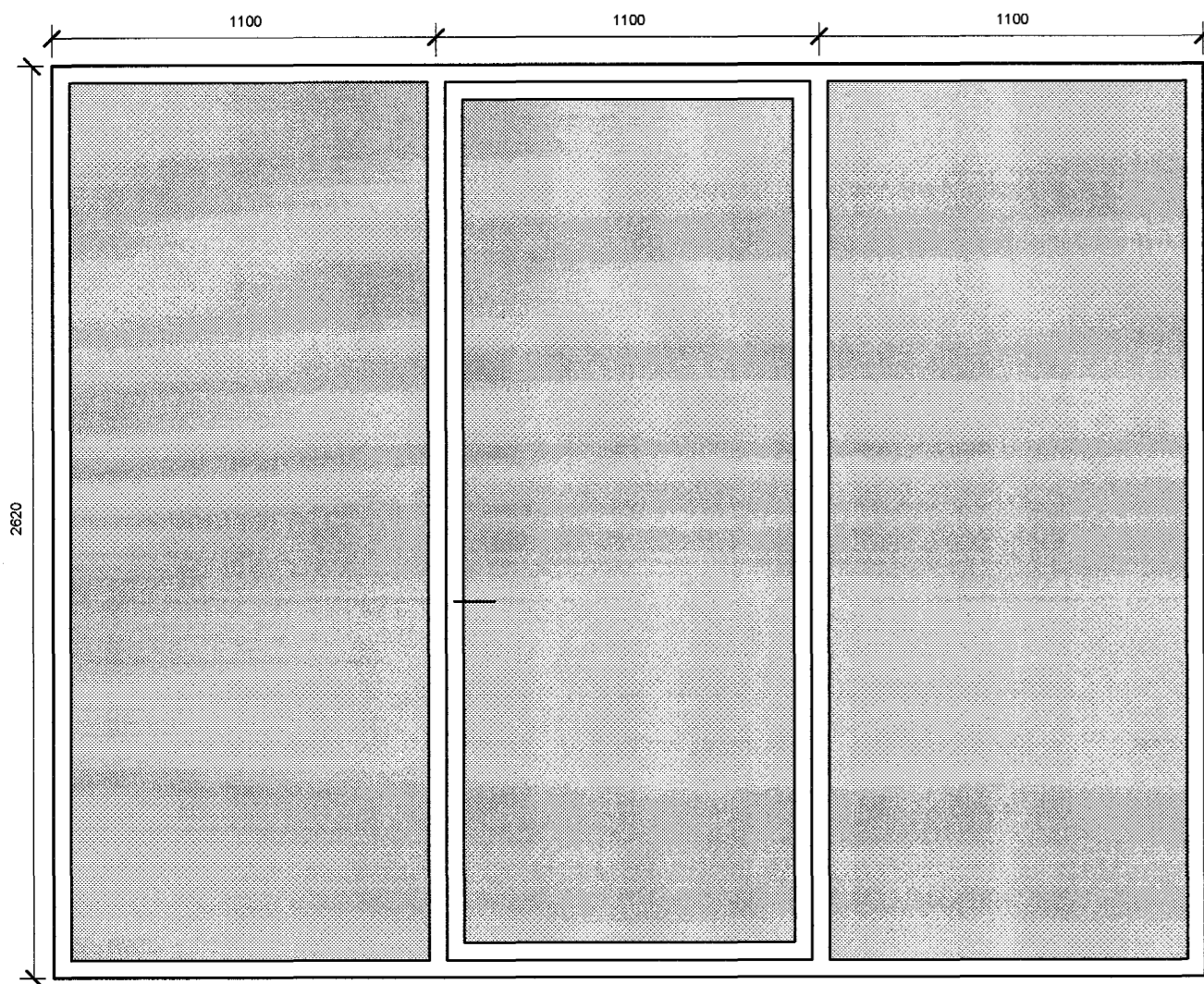

G-1, 2 STK. EFRI BRÚN 2620 mm YFIR ENDANLEGU GÓLFI. RENNIBURÐ OPNAST TIL HÆGRI Í ÖÐRUM EN VINSTRI Í HINUM

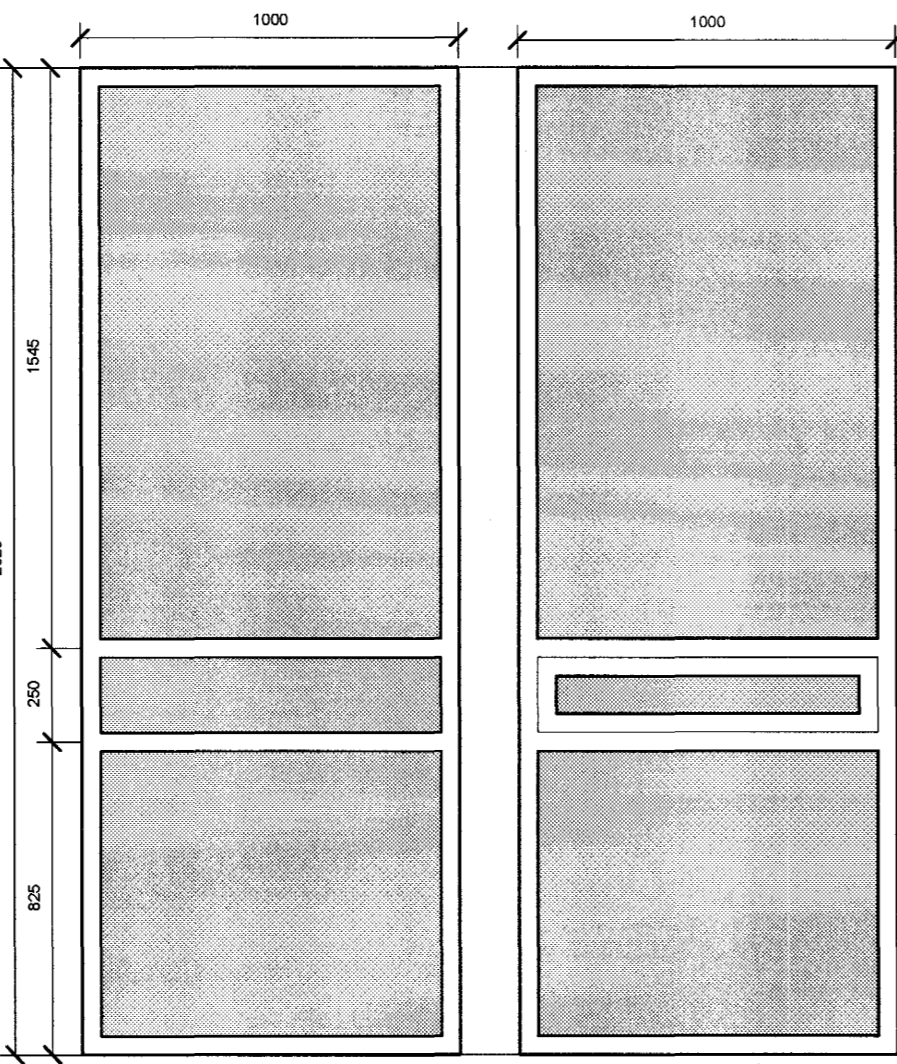

G-7, 1 STK. EFRI BRÚN 2620 mm Y. E. GÓLFI SETTUR SAMAN VIÐ G-9 SEM HORNGLUGGI

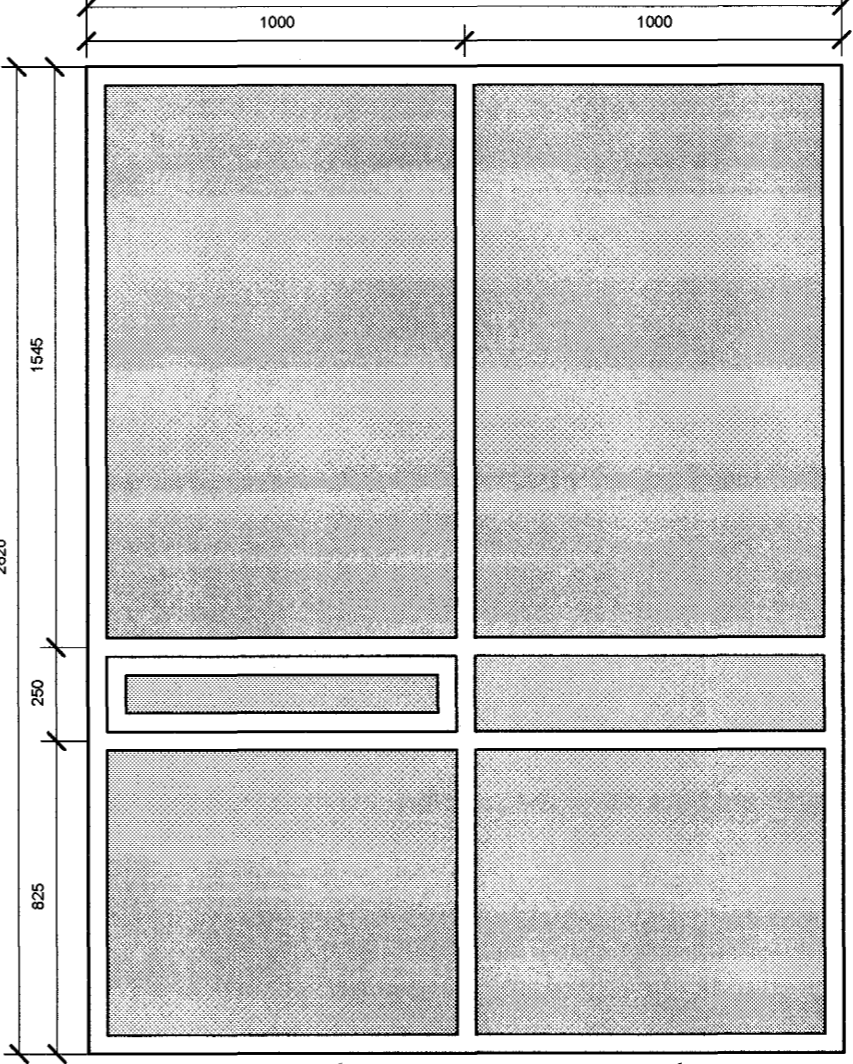

G-16, 1 STK. EFRI BRÚN 2620 mm YFIR ENDANL. GÓLFI

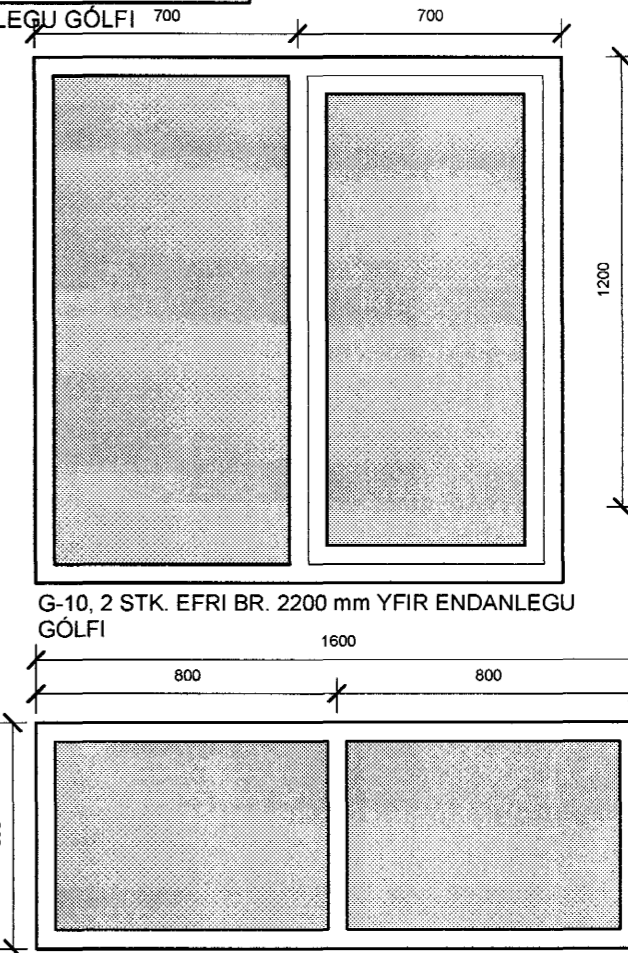

G-10, 2 STK. EFRI BR. 2200 mm YFIR ENDANLEGU GÓLFI

G-5, 1 STK. EFRI BR. 2200 mm YFIR ENDANLEGU GÓLFI

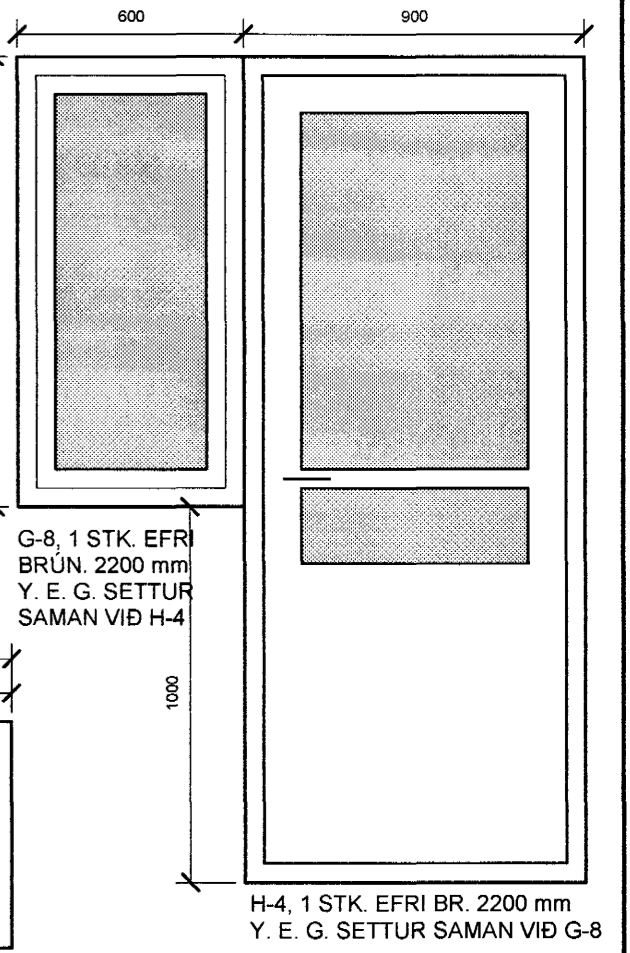

G-8, 1 STK. EFRI BRÚN. 2200 mm Y. E. G. SETTUR SAMAN VIÐ H-4

H-4, 1 STK. EFRI BR. 2200 mm Y. E. G. SETTUR SAMAN VIÐ G-8

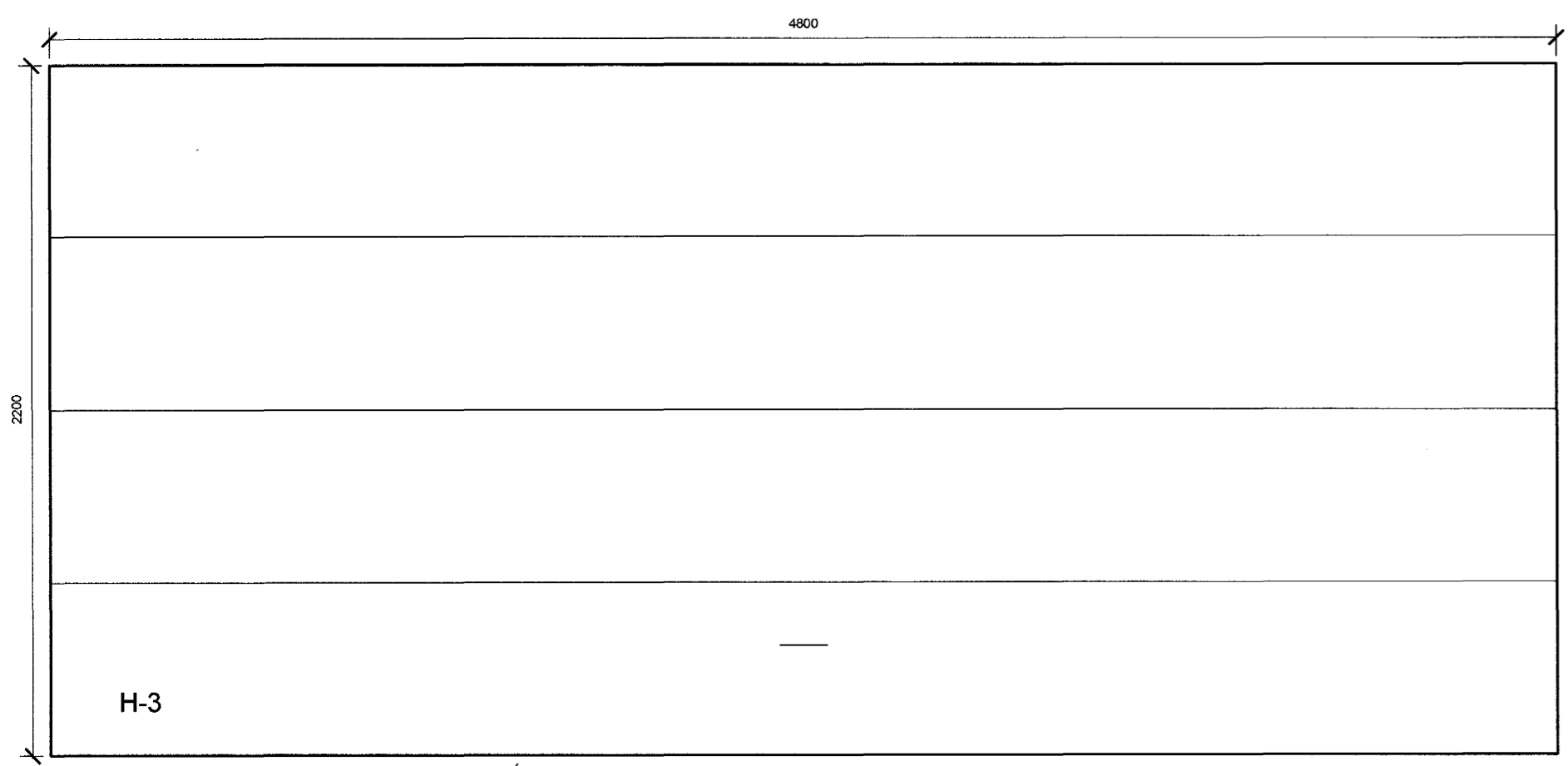

H-3, 1 STK. EFRI BR. 2200 mm YFIR ENDANLEGU GÓLFI.

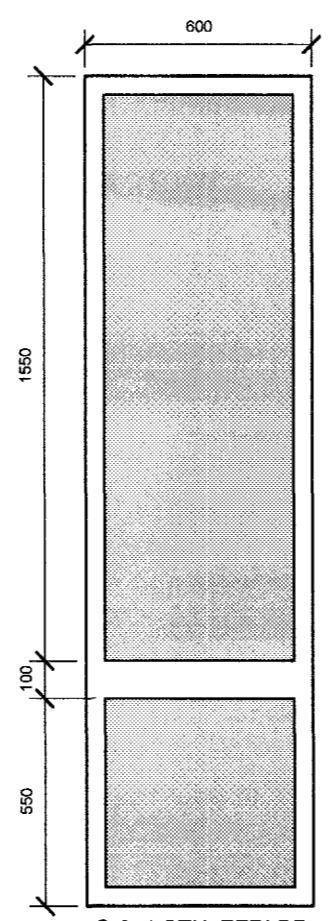

G-3, 1 STK. EFRI BR. 2200 mm Y. E. G.

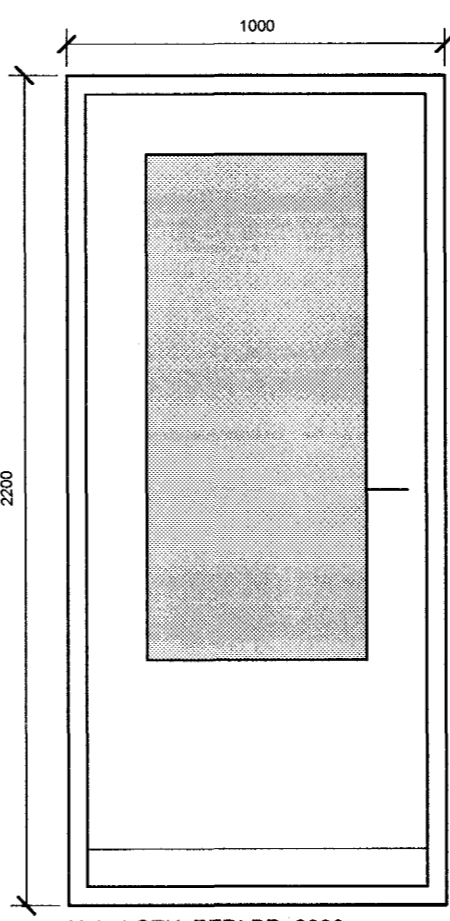

H-1, 1 STK. EFRI BR. 2200 mm YFIR ENDANLEGU GÓLFI

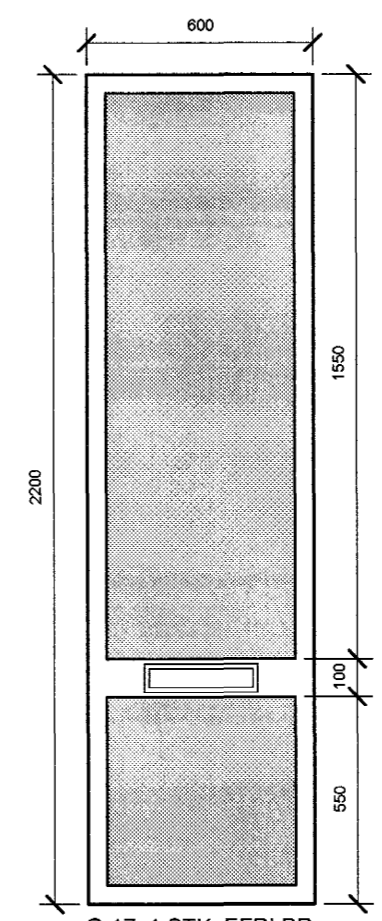

G-17, 1 STK. EFRI BR. 2200 mm Y. E. G.

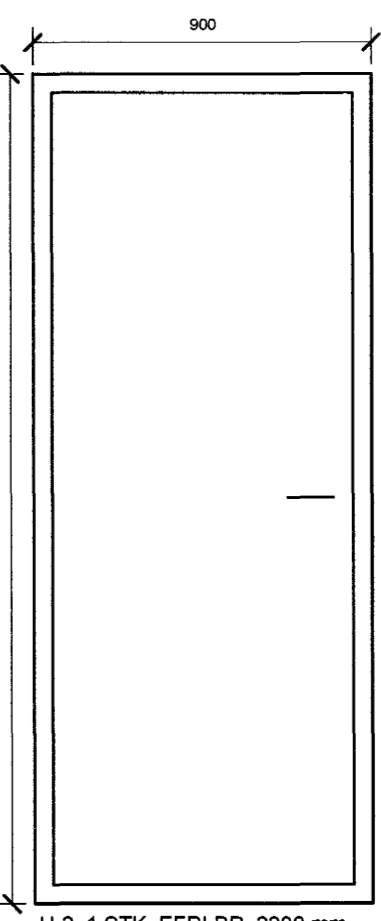

H-2, 1 STK. EFRI BR. 2200 mm YFIR ENDANLEGU GÓLFI

**RÝMA, arkitektar**

**Gunnlaugur Jónsson**

Klapparstíg 25-27, 101 Reykjavík,  
s: 562 1695 f: 562 1655

*Sambýkt þann*

Verk: Furuvalir 12i 4 SEPT. 2004

Byggingafultrúinn í Hafnarfirði  
F.h. Sigurbjartur Halldórsson

Teikning: Guggar og hurðir

Unnið fyrir: Steinunni Ólafsdóttur og  
Atla Ísaksson

Mælikvarði: 1:20	Dagsetning: 03.03.2004	Teiknað: GJ	Teikning nr: 0306-2001
---------------------	---------------------------	----------------	---------------------------

Breytingar:

Gunnlaugur Jónsson arkitekt FAÍ, 090462 2299