

BURKNAVELLIR 19 HAFNARFIRÐI.

GLUGGAR OG HURÐIR 1. HÆÐ.

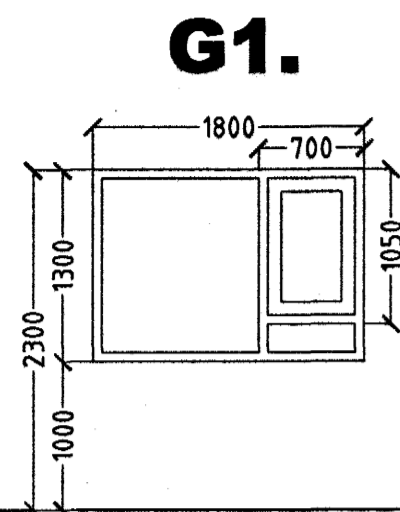

G1.
10. STK. HERB./HJÓN.
BJÖRGUNAROP.

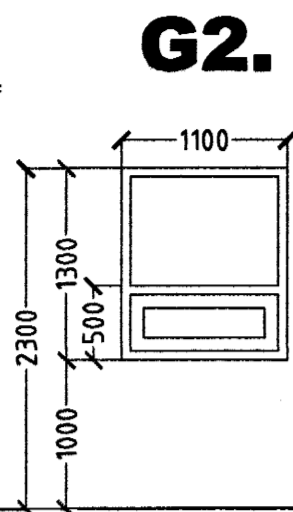

G2.
3. STK. ELDHÚS.

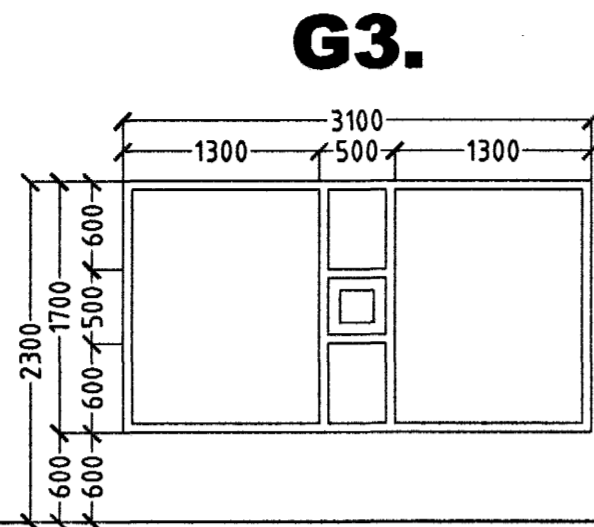

G3.
3. STK. STOFA.

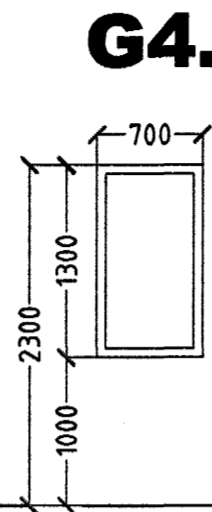

G4.
2. STK. HERB.

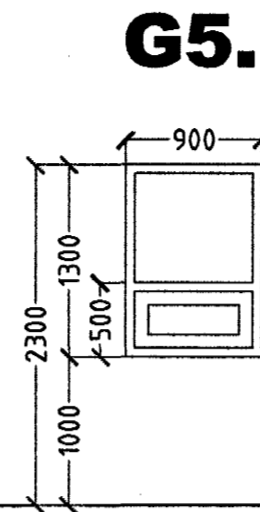

G5.
1. STK. HERB.

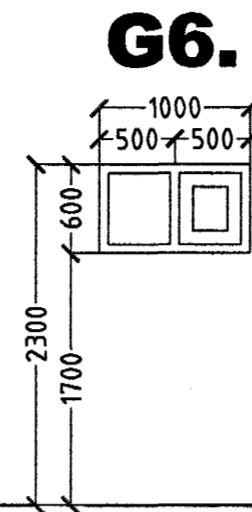

G6.
2. STK. BAÐ.

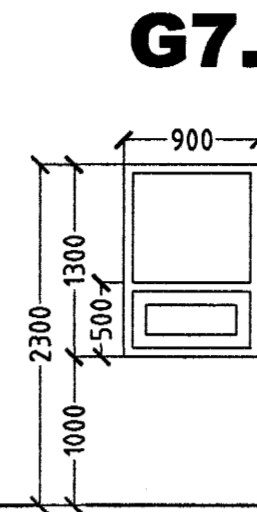

G7.
3. STK. GEYMSLA/
RAF. INNTÖK.

G9.

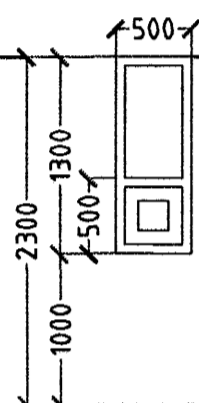

1. STK. ÞVOTTUR.

G10.

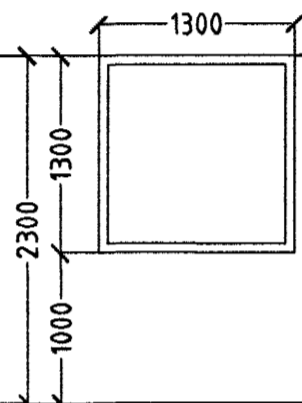

1. STK. ELDHÚS.

G11.

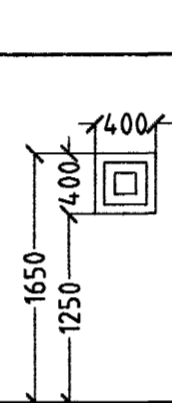

3. STK. STOFA.

G12.

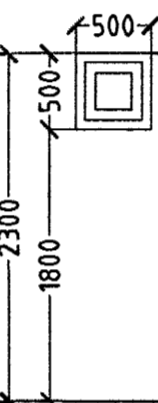

1. STK. HJÓL OG VAGNAR.

H1.

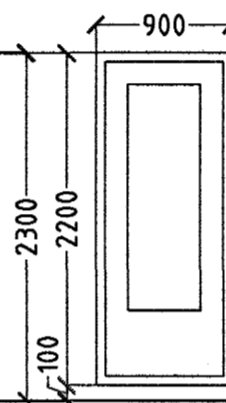

1. STK. STOFA.
HURÐ OPNAST VINSTRI ÚT.
2. STK. STOFA.
HURÐ OPNAST HÆGRI ÚT.

H2.

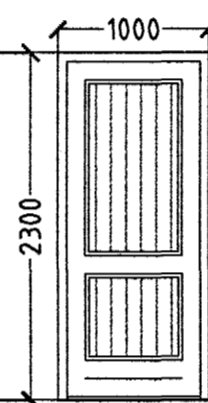

1. STK. HJÓL OG VAGNAR.
HURÐ OPNAST VINSTRI INN.

H3.

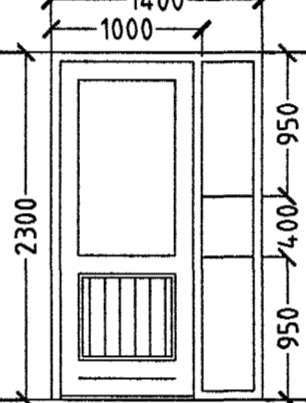

1. STK. ANDDYRI.
HURÐ OPNAST HÆGRI INN.

H4.

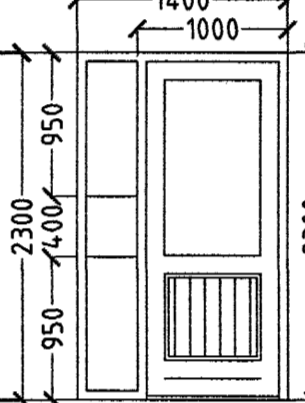

1. STK. ANDDYRI.
HURÐ OPNAST VINSTRI INN.

H5.

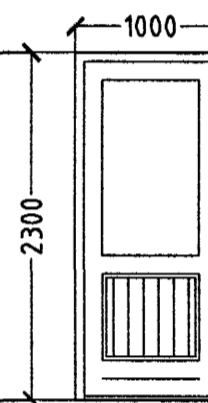

1. STK. ANDDYRI.
HURÐ OPNAST HÆGRI INN.

GLUGGAR OG HURÐIR 2. HÆÐ.

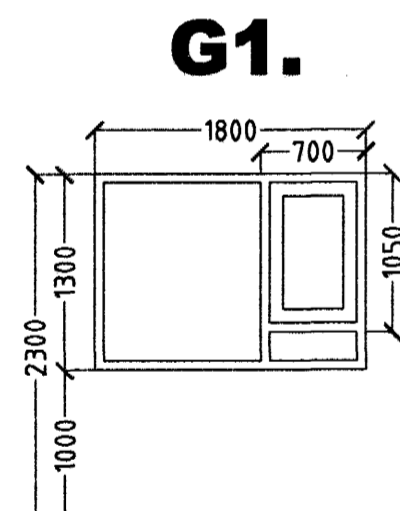

G1.
10. STK. HERB./HJÓN.
BJÖRGUNAROP.

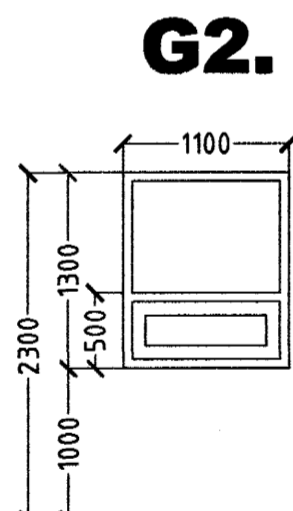

G2.
3. STK. ELDHÚS.

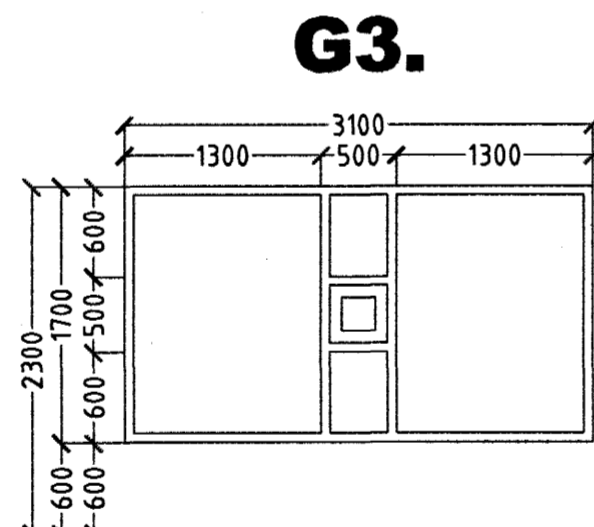

G3.
3. STK. STOFA.

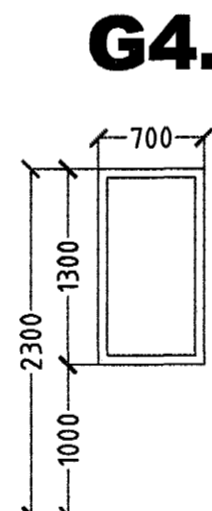

G4.
2. STK. HERB.

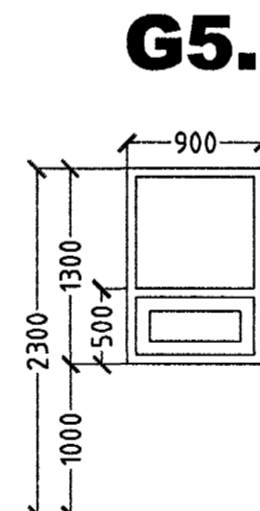

G5.
1. STK. HERB.

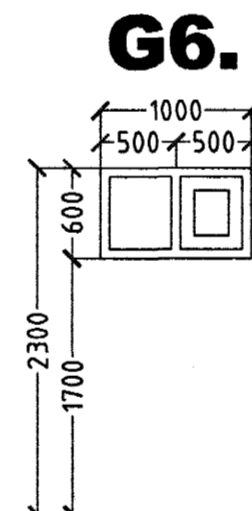

G6.
2. STK. BAÐ.

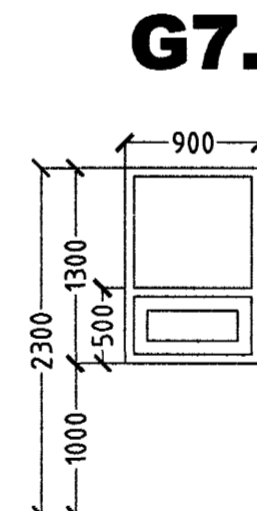

G7.
3. STK. GEYMSLA/
RAF. INNTÖK.

G9.

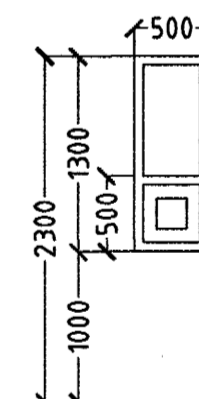

1. STK. ÞVOTTUR

G10.

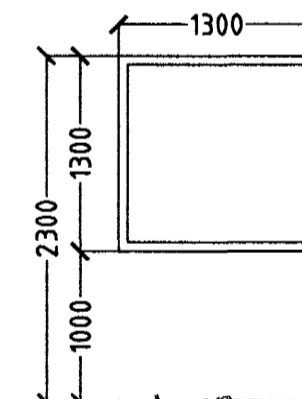

1. STK. ELDHÚS.

G11.

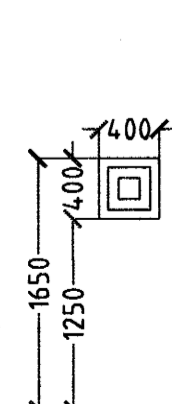

3. STK. STOFA.

G12.

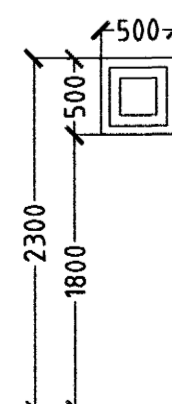

1. STK. HJÓL OG VAGNAR.

H1.

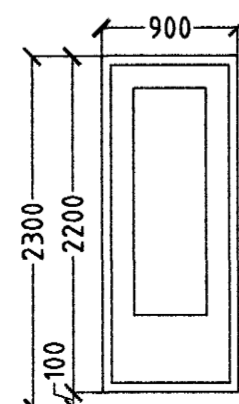

1. STK. STOFA.
HURÐ OPNAST VINSTRI ÚT.
2. STK. STOFA.
HURÐ OPNAST HÆGRI ÚT.

H2.

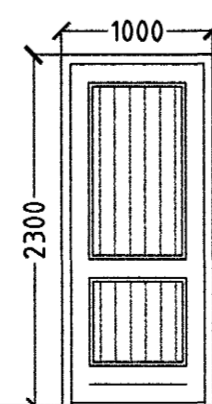

1. STK. HJÓL OG VAGNAR.
HURÐ OPNAST VINSTRI INN.

H3.

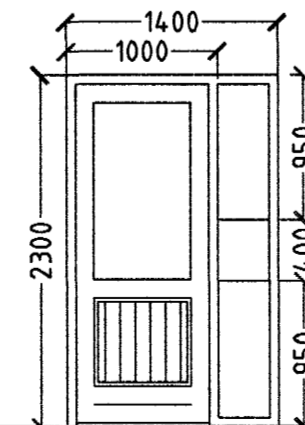

1. STK. ANDDYRI.
HURÐ OPNAST HÆGRI INN.

H4.

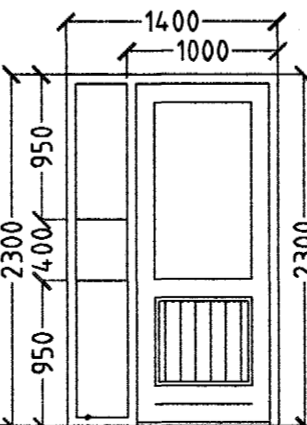

1. STK. ANDDYRI.
HURÐ OPNAST VINSTRI INN.

H5.

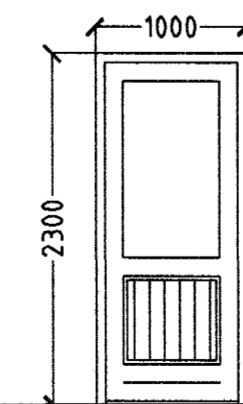

1. STK. ANDDYRI.
HURÐ OPNAST HÆGRI INN.

GLUGGAR OG HURÐIR 1. HÆÐ. 37 STK.
GLUGGAR OG HURÐIR 2. HÆÐ. 37 STK.
HEILDARFJÖLDI GLUGGA OG HURÐA. 74 STK.

ATH!
ÖLL MÁL ATHUGIST OG MÆLIST Á STAÐNUM
ÁÐUR EN SMÍÐI HEFST.

BURKNAVELLIR 19 HAFNARFIRÐI.

Sigurður Þorvarðarson byggingafræðingur bfi.
Teiknistofan Strandgötu 11 220 Hafnarfirði.
Sími: 5651510. Netfang: teiknistofan@istandia.is
STH. teiknistofan ehf. kt. 510298-2769. Kf. aðalhönnuðar: 141250-4189.

| | |
|--------------|--------------------------------|
| Skýringar: | Séruppdráttur. |
| Teikning: | Gluggar og hurðir 1. & 2. hæð. |
| Mælikvæði: | 1:50. |
| Undirskrift: | <i>6/10/04 [Signature]</i> |
| Blað nr: | 7 af 7. |
| Dagsetning: | 11 febrúar 2004. |
| Breytt: | |

Byggingafræðingur
F.h. Sigurbjartur Halldórsson

12 OKT. 2004