

**I-N**  
1. stk  
Hurðin sem kemur í gang, nálægt mátlínu (6) er EI-CS30 eldvarnarhurð. Hurðunum er haldið opnum með segli sem sleppir þegar brunakerfið gerir viðvart.

**I-A**  
2. stk

**I-B**  
2. stk

**I-C EI-CS30**  
2. stk

**I-D EI-CS30**  
2. stk

**I-E**  
15. stk  
Þar af er 1 hurð EI-CS30 inn í rými (26) eldhús og 1 hurð EI-CS60 inn í rými (30) tæknirými

**I-F**  
12. stk  
Þar af er ein hurð EI-CS30 sem kemur inn í rými (26) eldhús

**I-M**  
2. stk

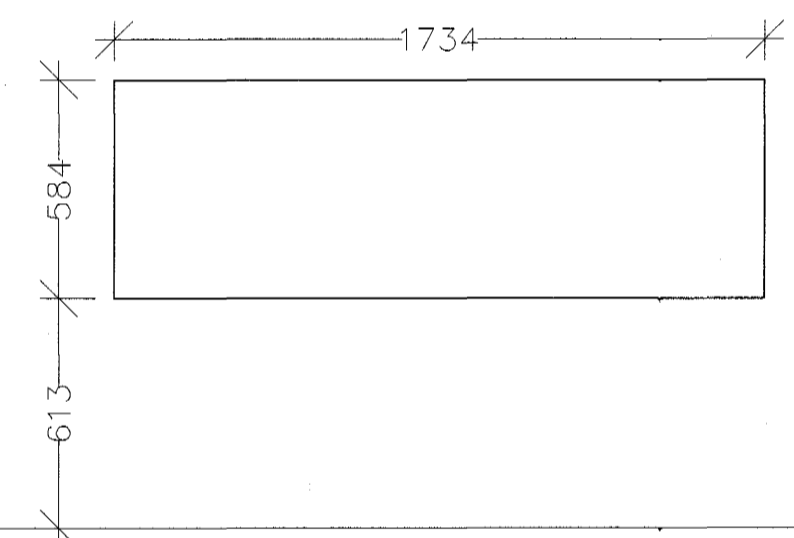
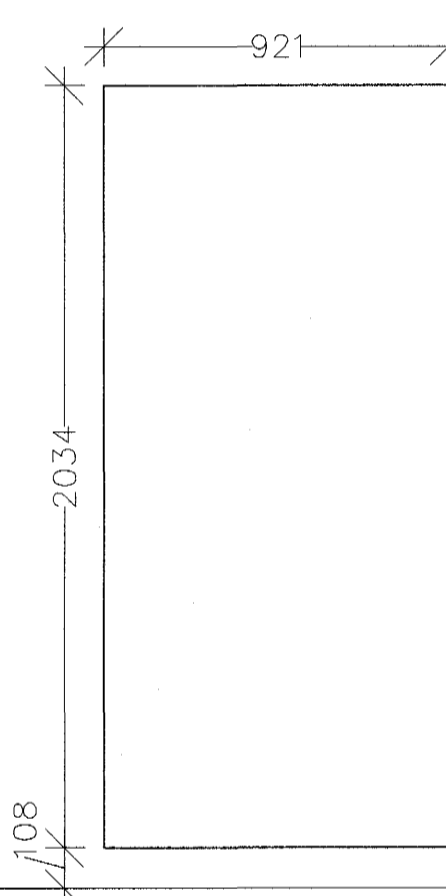
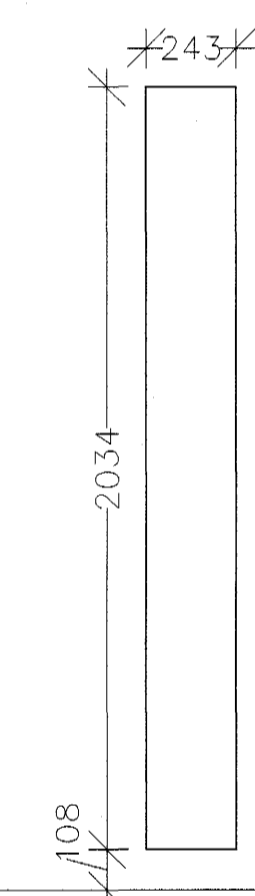

Rúður við hlið hurða inn í rými 8,9,10,11,16, 21, 33, 38.  
8 stk.  
ATH. nákvæm mál takist á staðnum

Rúður við hlið hurða inn í rými 13, kaffistofu starfsfólks  
2 stk.  
ATH. nákvæm mál takist á staðnum

Rúður í heimastofum, rými 16, 21, 33, 38.  
4 stk.  
ATH. nákvæm mál takist á staðnum

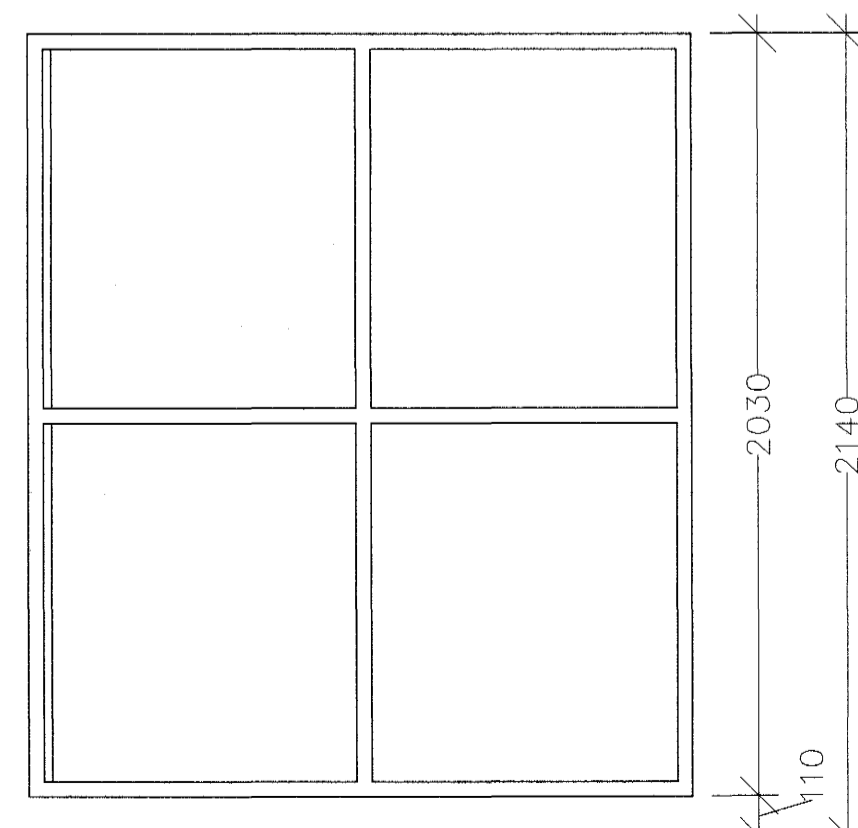
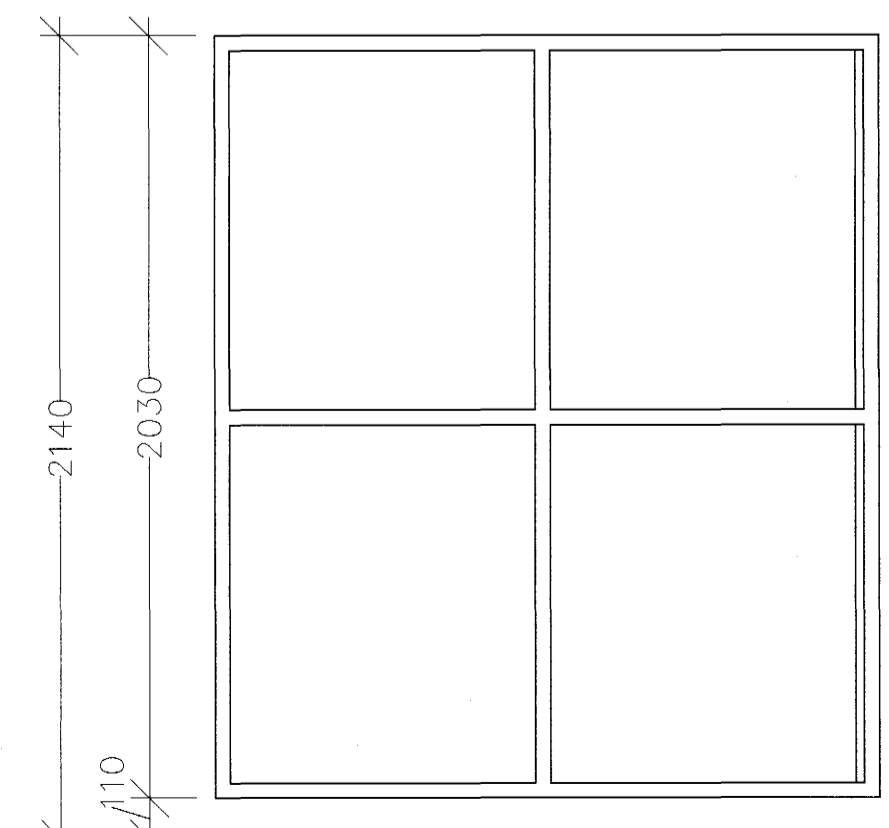
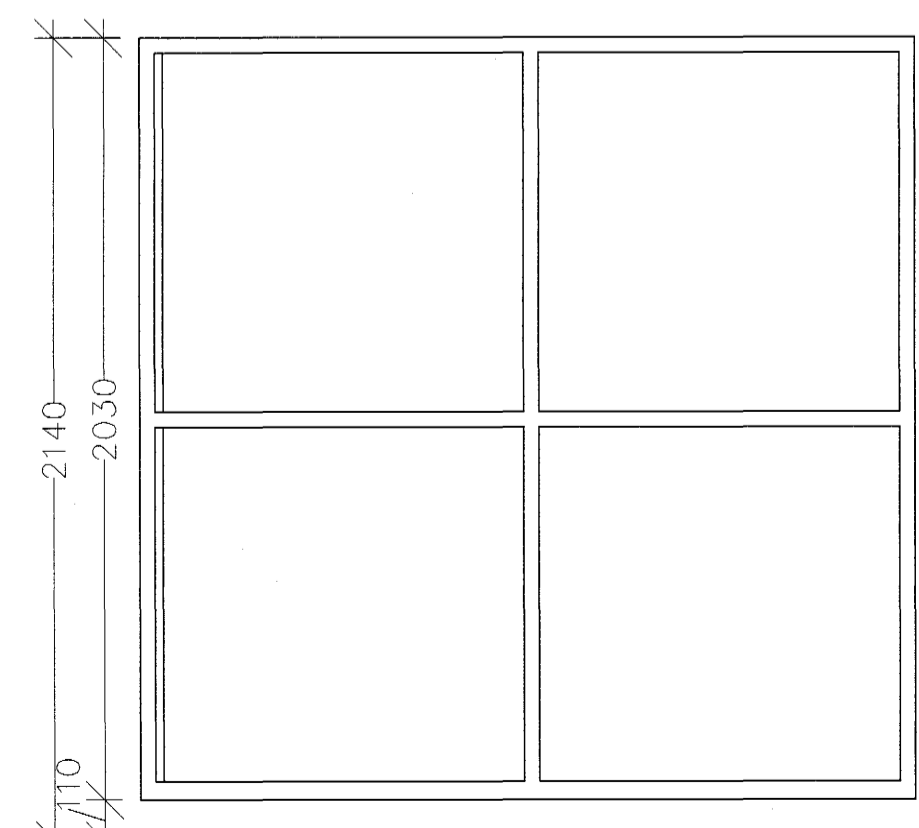
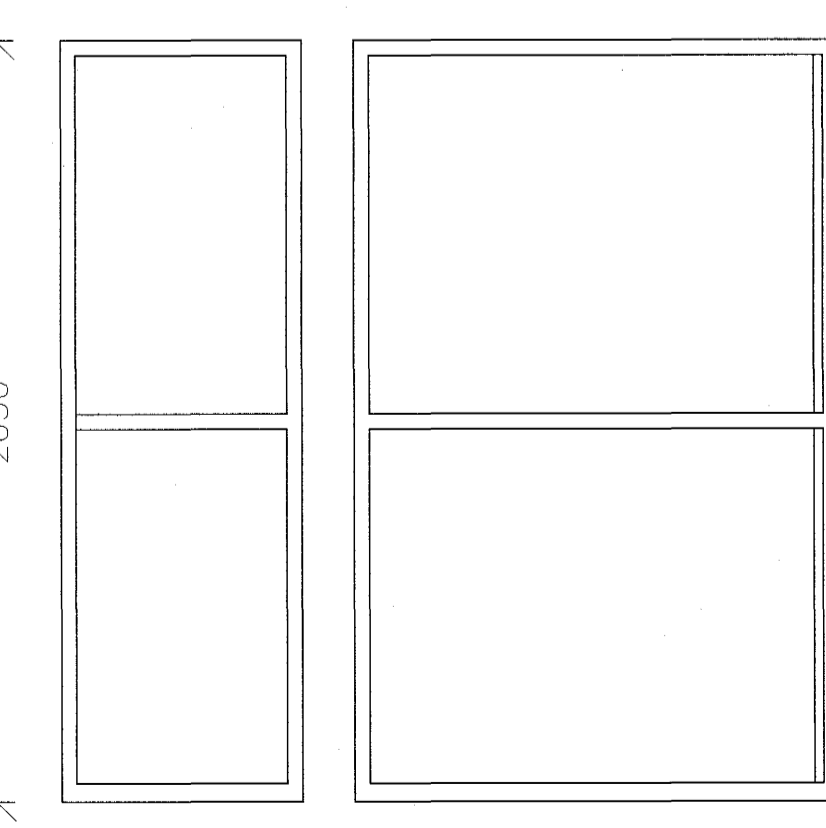
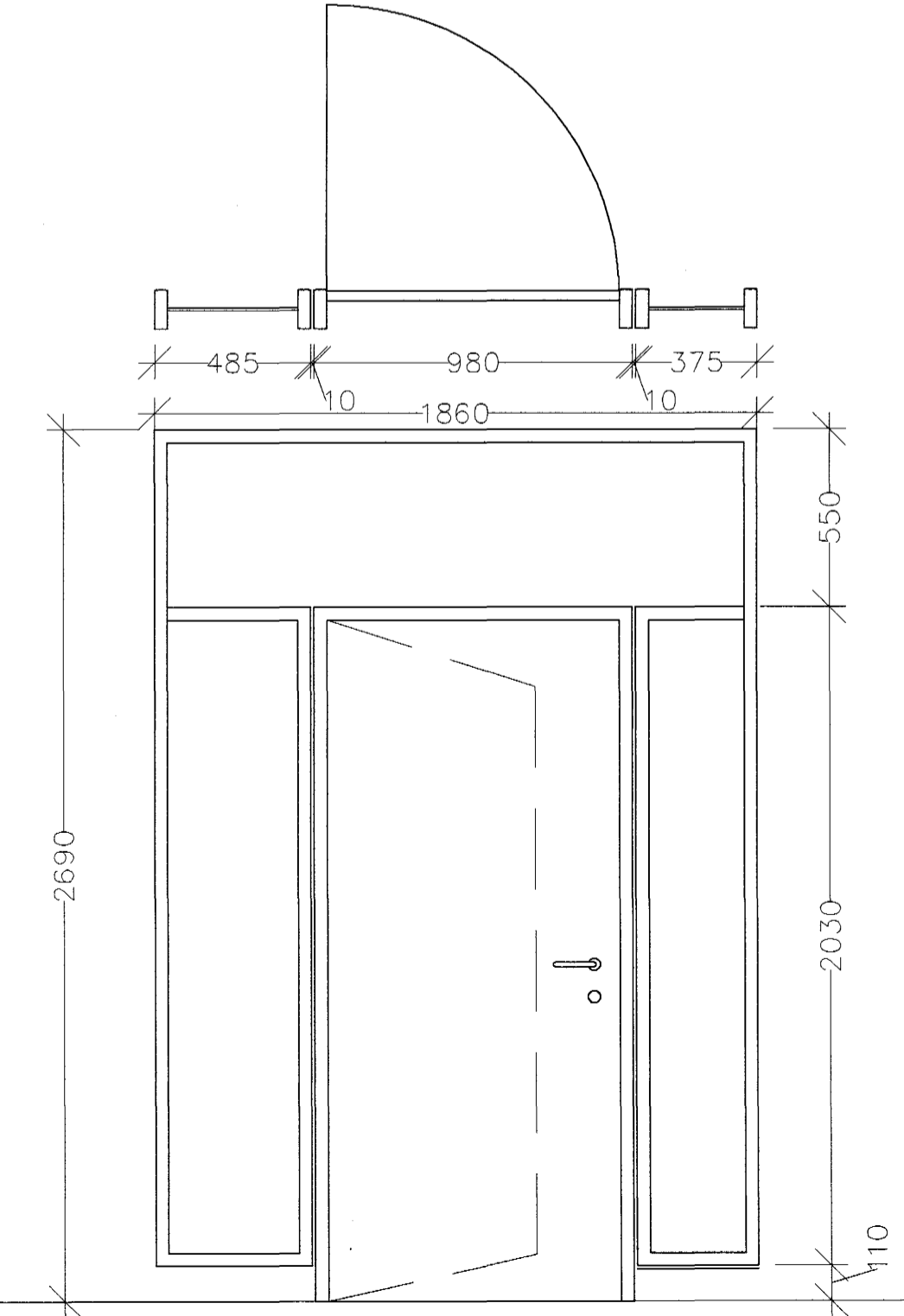
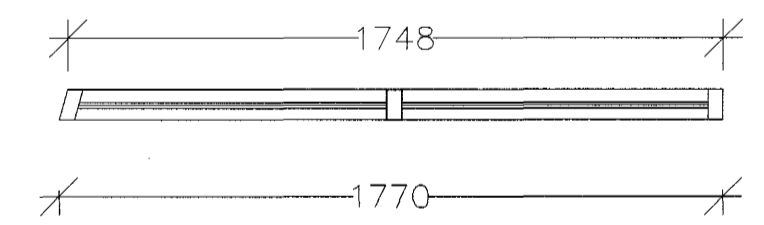
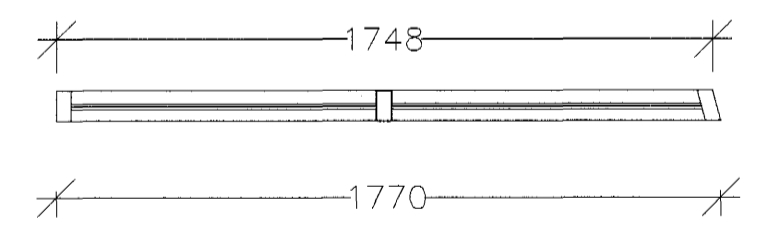
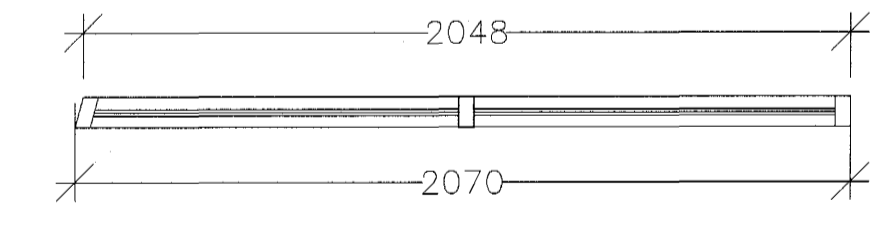
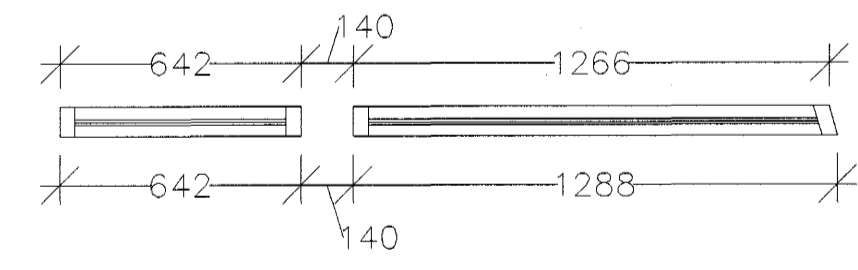

**I-H E-30**  
1. stk

**I-I E-30**  
1. stk

**I-J E-30**  
1. stk

**I-K E-30**  
1. stk

**I-L E-30**  
1. stk

**I-G**  
2. stk

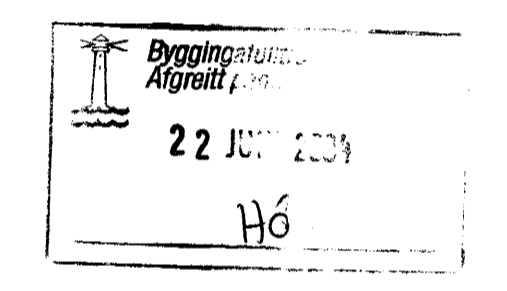

*H.C. 22.11.01*

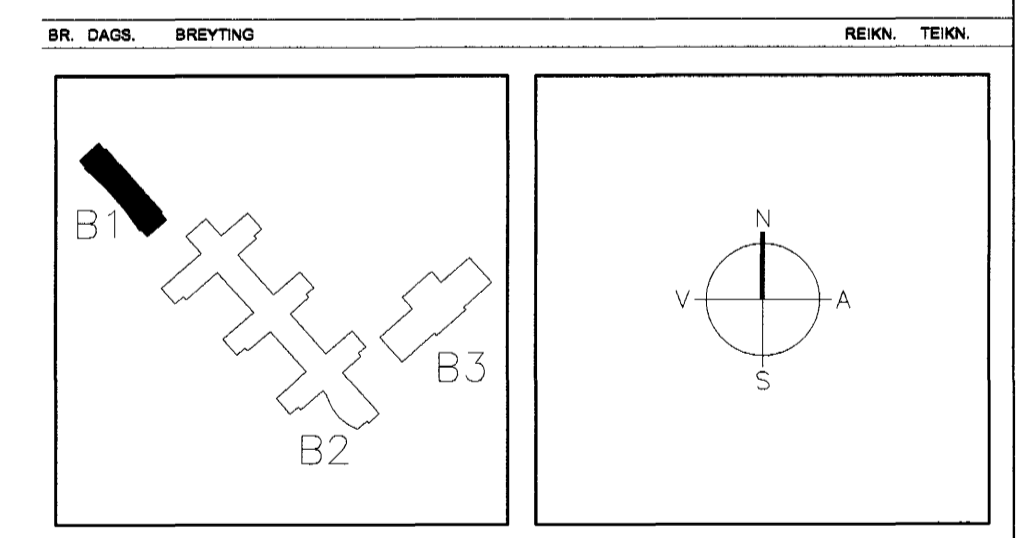

**ARKITEKTAR**  
BERGSTADASTRÆTI 10, RVK.  
Sími: 551-1460, netfang: arkitekt@sthoif.is

**FINNUR BJÖRGVINSSON**  
**HILMAR ÞÓR BJÖRNSSON**  
**SIGRÍÐUR ÓLAFSDÓTTIR**

**LANDMÖTUN.**  
EINAR E. SÆMUNDSEN  
INGIBJÖRG KRISTJÁNSDÓTTIR  
MARGRÉT SIGURDARDÓTTIR

**VSÓ**  
VÍSÓ RÁÐGJÖF

**TJARNARBRAUT 30**  
LEIKSKÓLINN HÖRÐUELLIR

YFIRLIT INNIHURDA OG -GLUGGA

HANNAÐ/TEKN. 1:20  
ATH. REYKJAVÍK 19.11.2001  
SAMBÝKKT KT. 060288-1389  
VERKNR. REYKJAVÍK 19.11.2001  
BR. REYKJAVÍK 19.11.2001  
BR. REYKJAVÍK 19.11.2001

**B1-A-VF-001**