

G1-7 STK. H=95

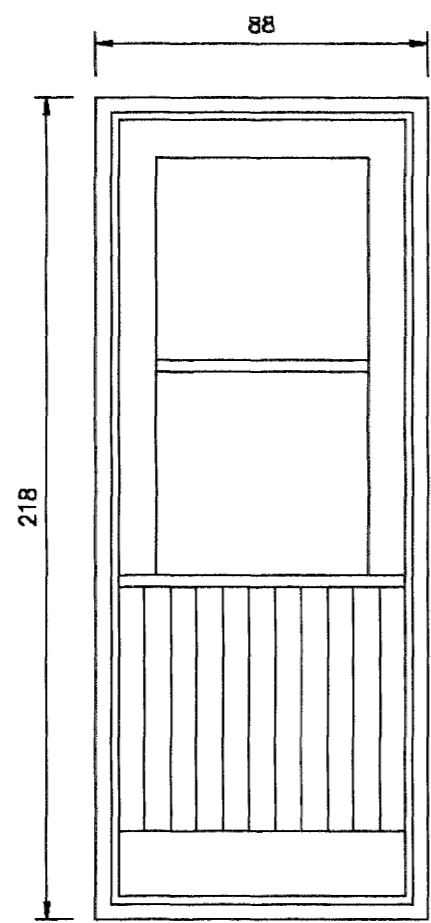

G4-1 STK. H=7

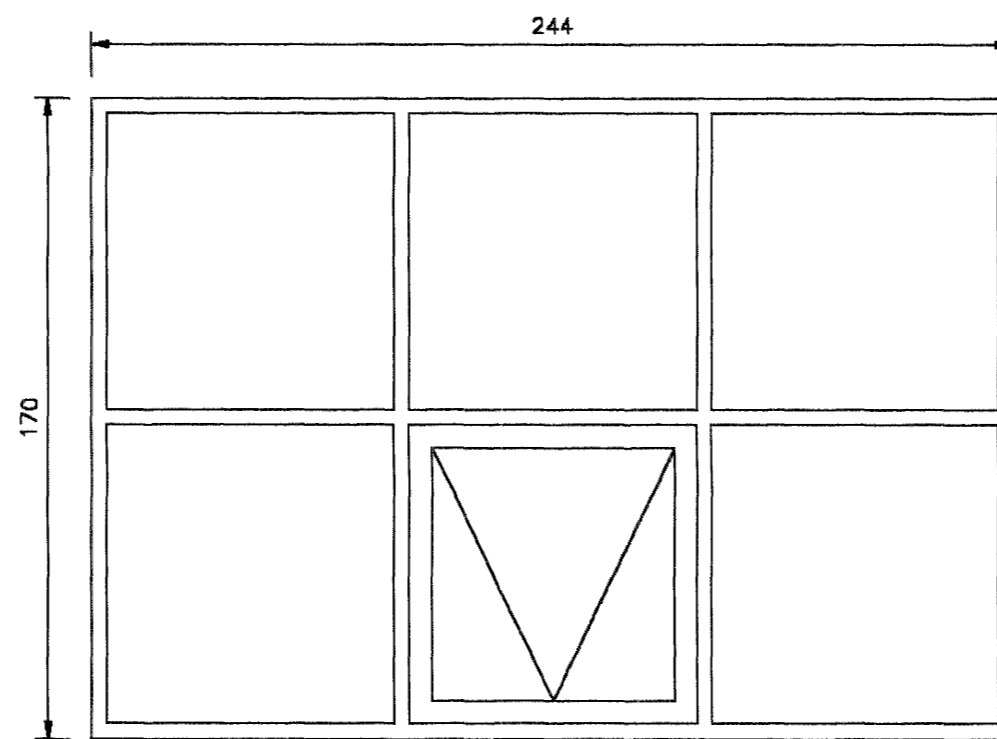

G6-2 STK. H=55

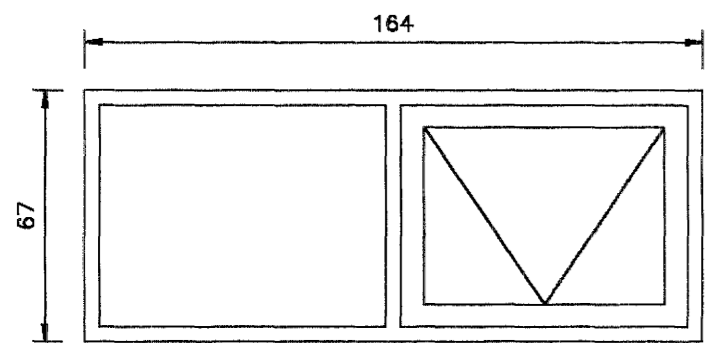

G2- 3 STK. H=158

H=HÆÐ YFIR GÖLFKÓTA

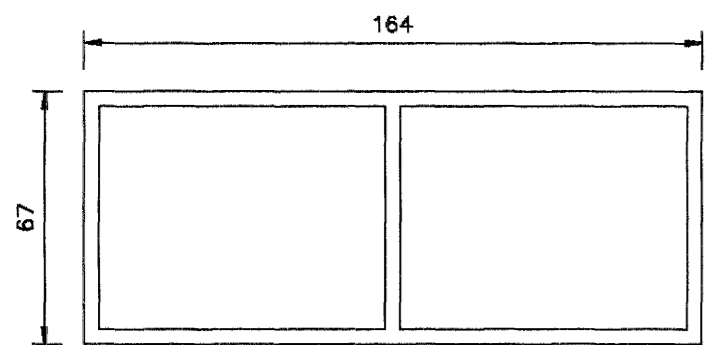

G3-2 STK. H=158

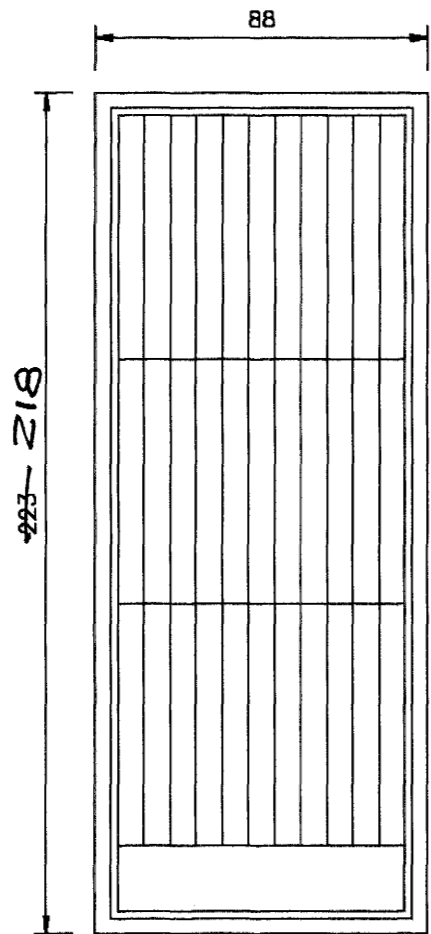

G5-1 STK. H=7

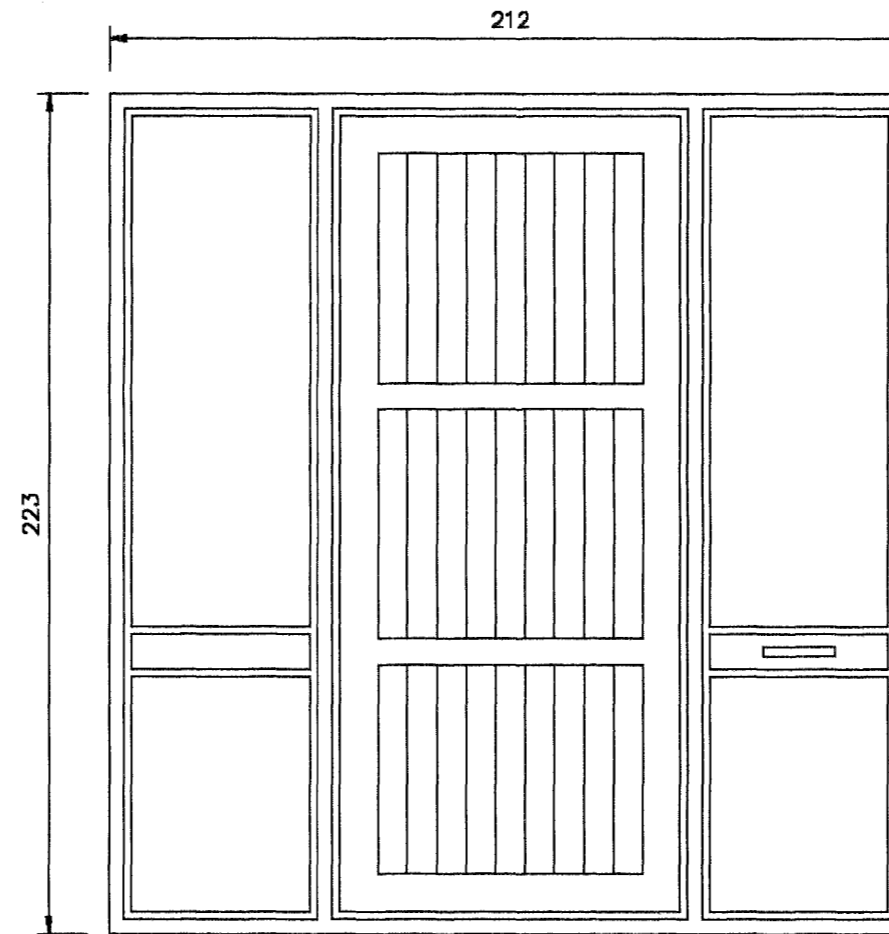

AÐALHURÐ-1 STK. H=2

Samþykkt þann

24 MAI 2004

Byggingafulltrúinn í Hafnarfirði  
F.h. Sigurbjartur Halldórsson

TEIKNISTOFA AGNARS MAGNÚSSONAR  
STIGAHLÍÐ 2, REYKJAVÍK. SÍMI: 565-1412

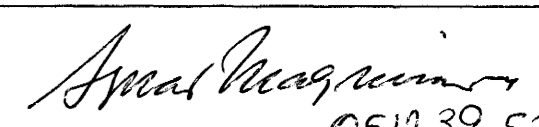
FURUVELLIR NR.42	TEIKNING NR. H64-1- 3
M=1:20	REYKJAVÍK Í FEBRÚAR 2004
GLUGGAR OG HURÐIR	
 0512 39 58.09	

BYGGINGAVERKFRÉÐINGUR FVFÍ OG BYGGINGATEKNIFRÉÐINGUR