

BLÓMVELLIR 24. HAFNARFIRÐI.

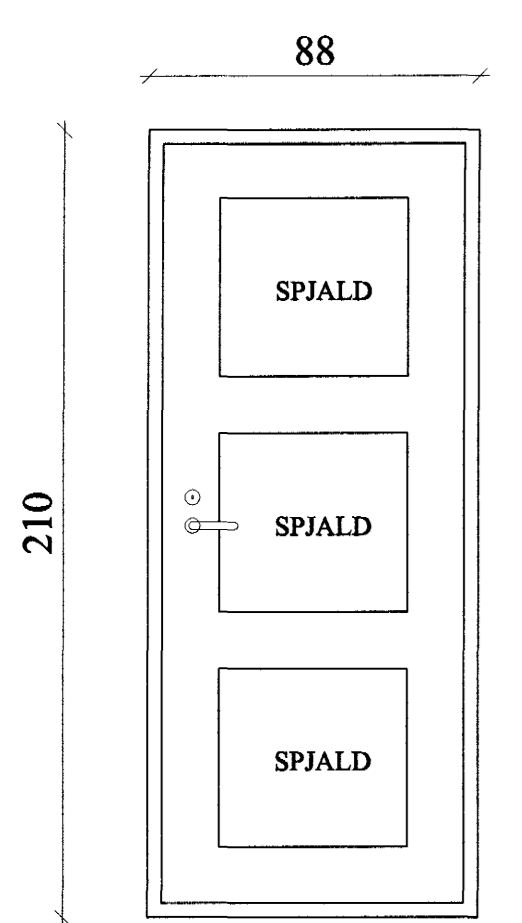

HURÐASPJALD 80
MÁL TAKIST Á STAÐNUM
G 1 . 2.stk.
bílskúr
geymsla

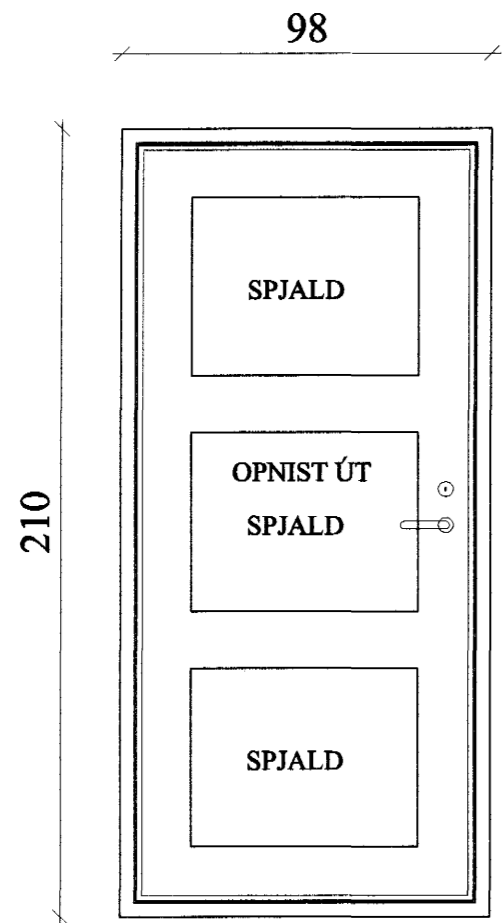

HURÐASPJALD 900
MÁL TAKIST Á STAÐNUM
G 2. 1.stk.
bílskúr

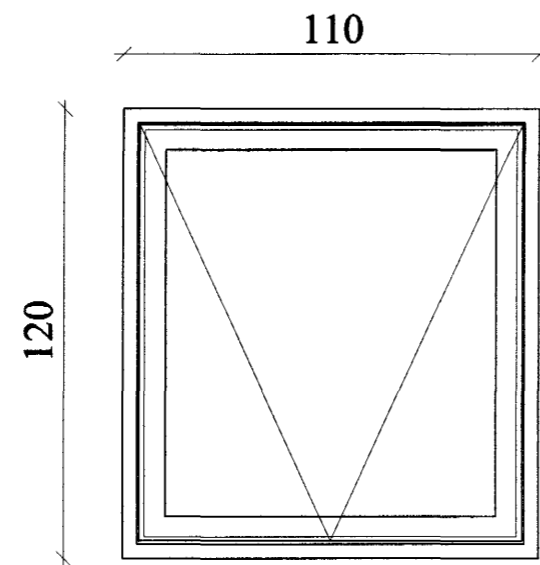

G 3. 6.stk.

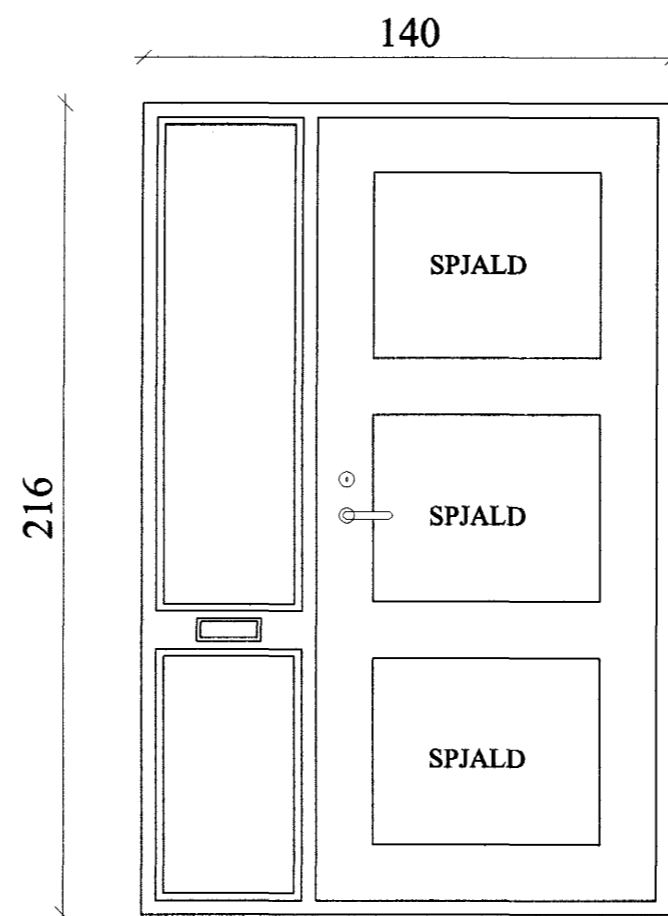

HURÐASPJALD 900
MÁL TAKIST Á STAÐNUM
G 4 . 1.stk.
útihurð

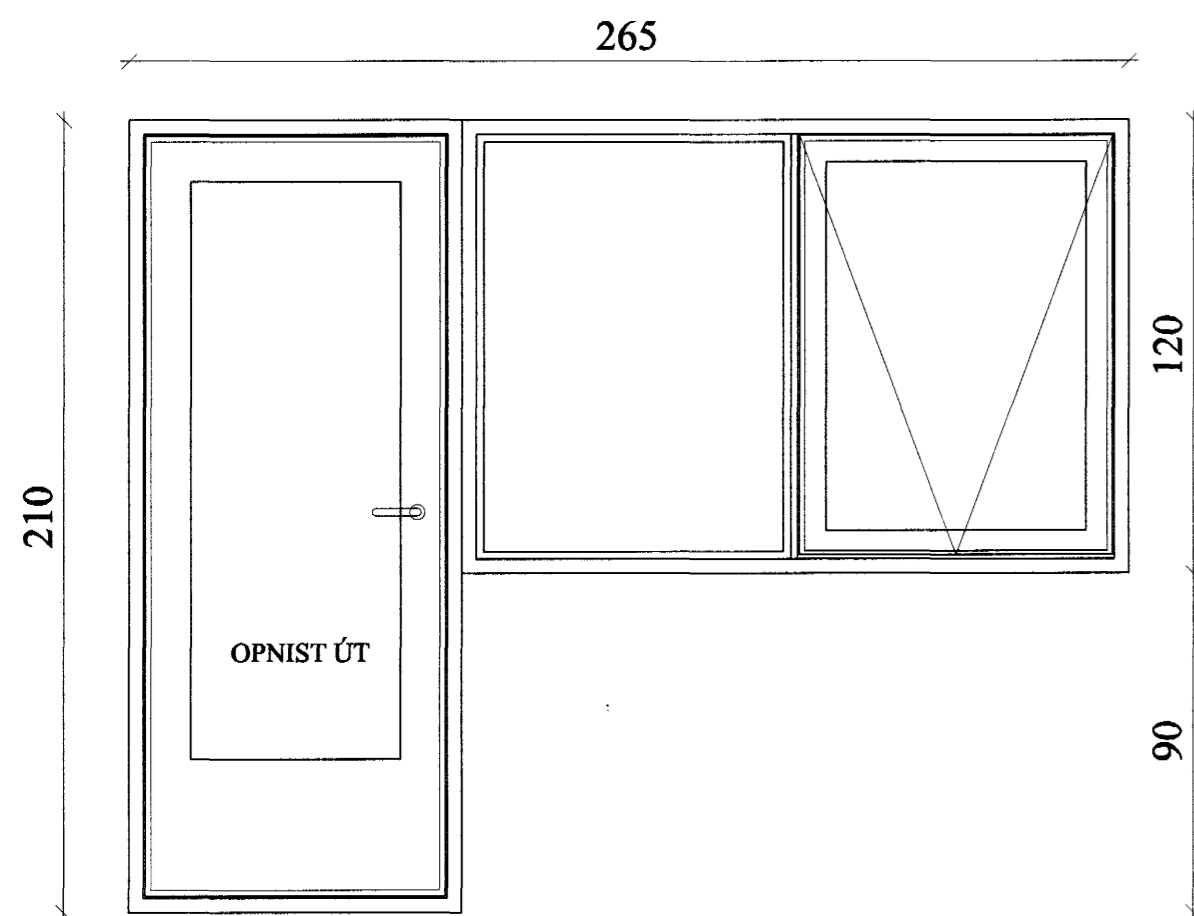

G 6. 1.stk.

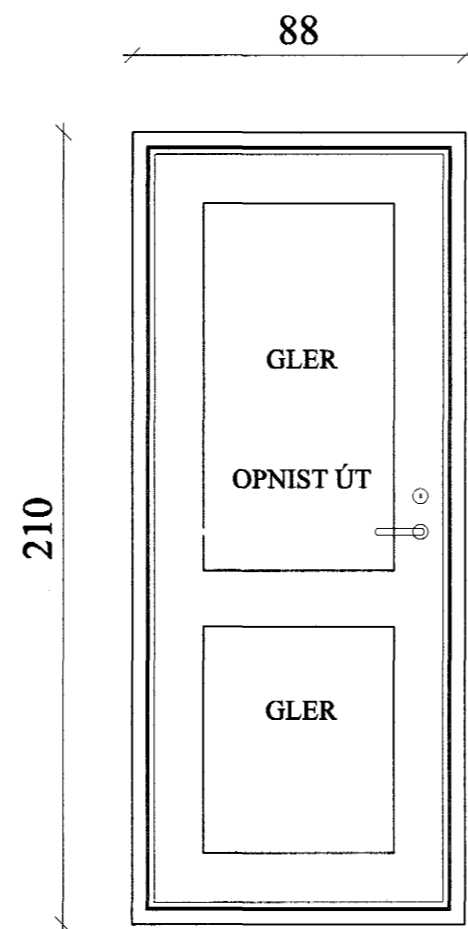

HURÐASPJALD 80
MÁL TAKIST Á STAÐNUM
G 7. 1.stk.
svalahurð

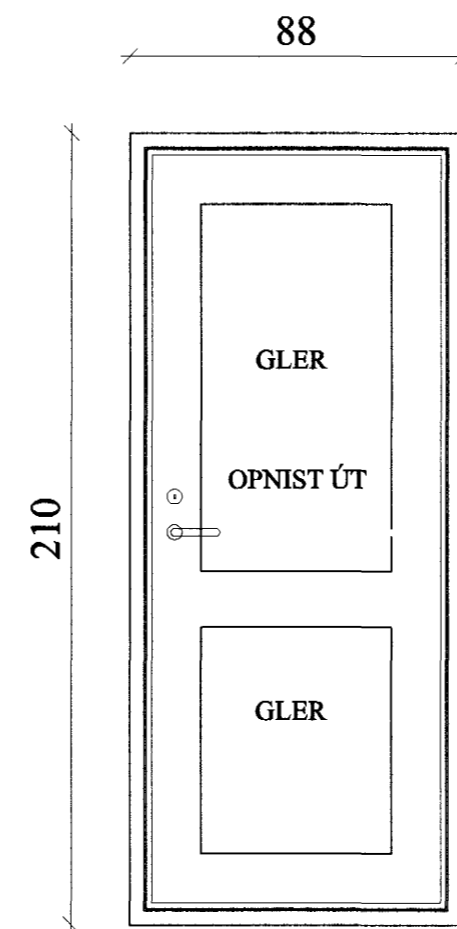

HURÐASPJALD 80
MÁL TAKIST Á STAÐNUM
G 8. 1.stk.
baðhurð

SKÝRINGAR:
HURÐIR OG GLUGGAR ERU SÉÐ UTAN FRÁ.
GLUGGAR SKULU VERA ÚR VALINNI FURU EÐA BETRA EFNI.
OPNANLEG FÖG SKULU VERA ÚR OREGON PINE EÐA BETRA EFNI.
HURÐIR SKULU VERA ÚR OREGON PINE EÐA BETRA EFNI.
GLUGGAKARMAR SKULU SMÍÐAST ÚR 2 1/2"x5".

HORNGLUGGI. A 1.stk.

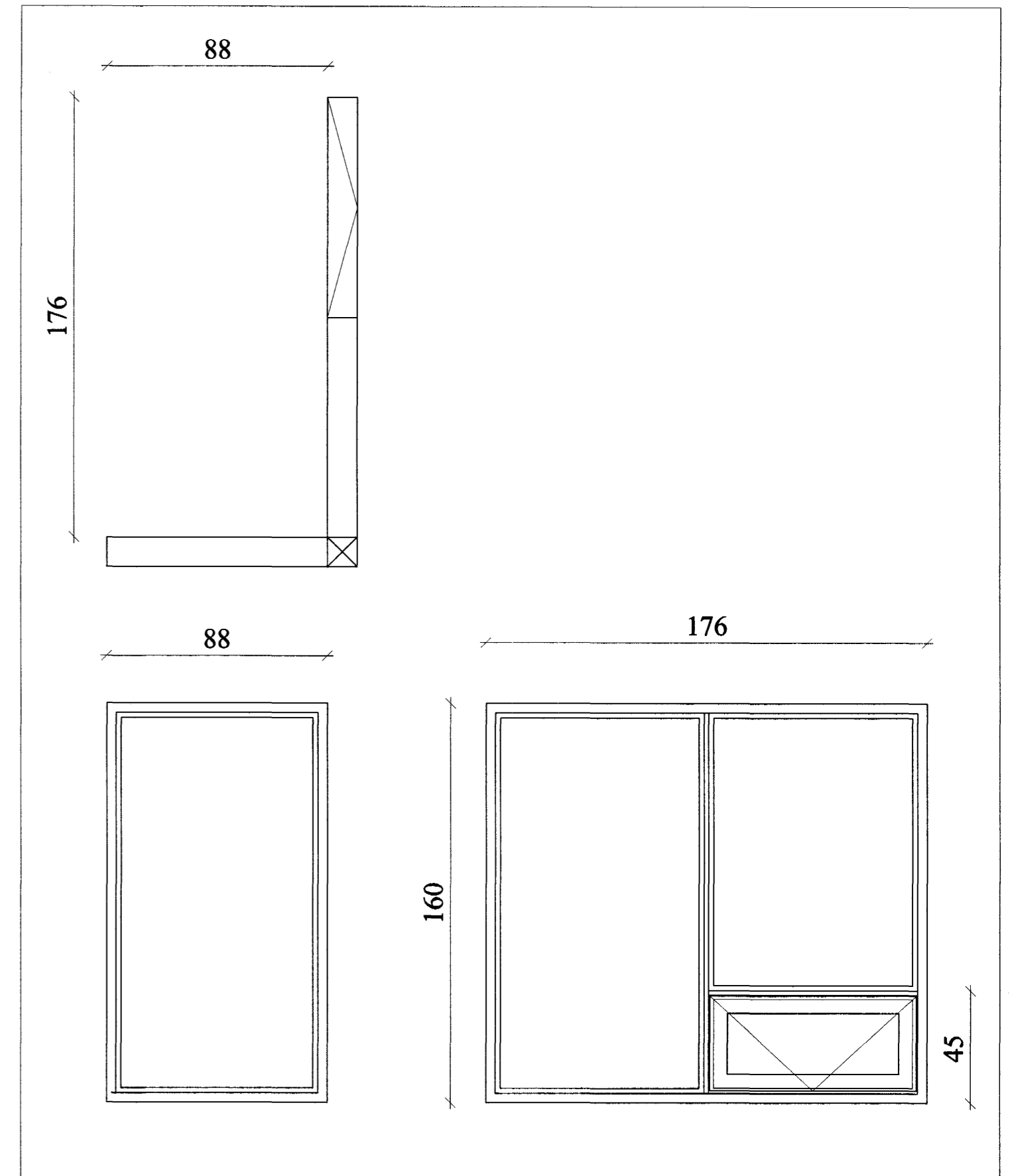

G 5. 1.stk.

Teiknistofan Húsagerð og Skipulag Birkiás 19. Garðabæ. Sími 8978564.
Gunnar Sigtryggur Einarsson Byggingafræðingur. BFÍ. kt. 020550.2369. e-m. gse@vortex.is

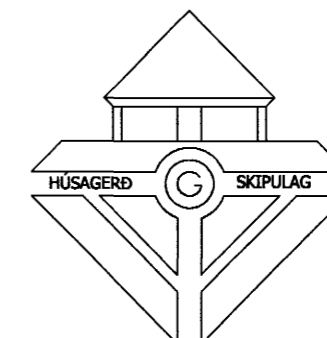

Verknúmer: 107.	08 JUNI 2003
Breytt:	VG
Dags: 20. mars 2003.	
Efni: Blómvellir 24. Hafnarfirði.	08
Heiti: Gluggar 1.	
Mkv: 1:20	
Hannað: <i>[Signature]</i>	