

	A	B	Fjöldi	Gerð
L1	1322	1512	8	L60x60x6
L2	1470	1550	1	L60x60x6
L3	1432	1512	24	L60x60x6

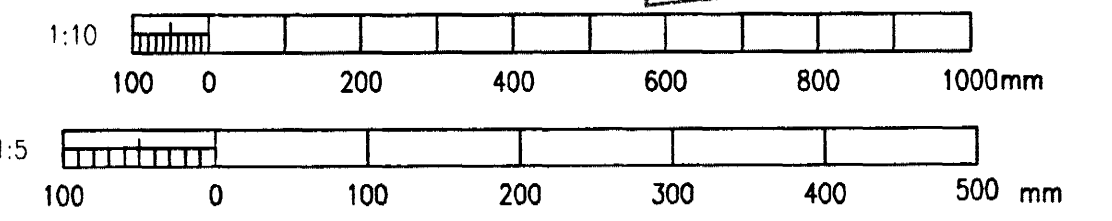
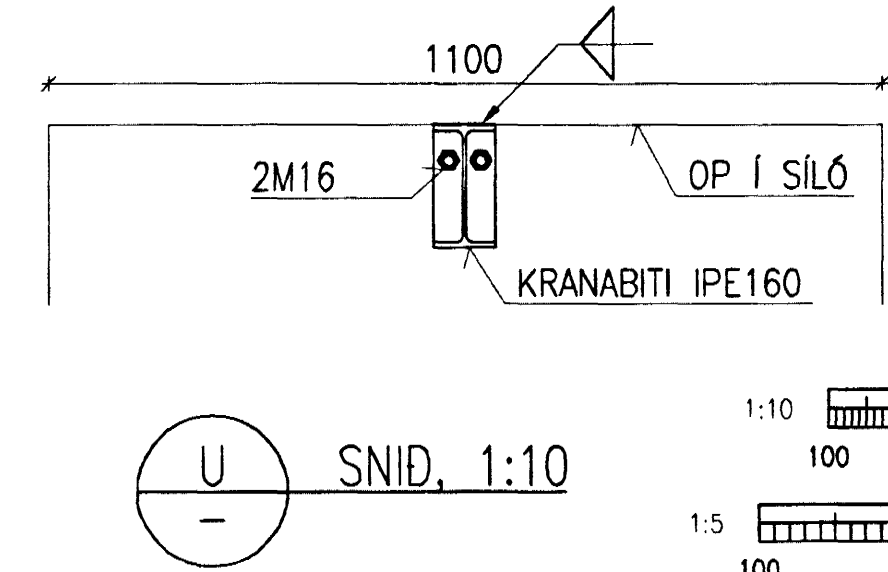
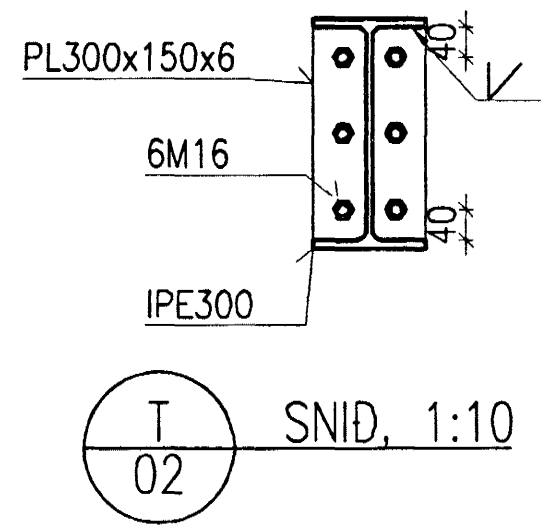
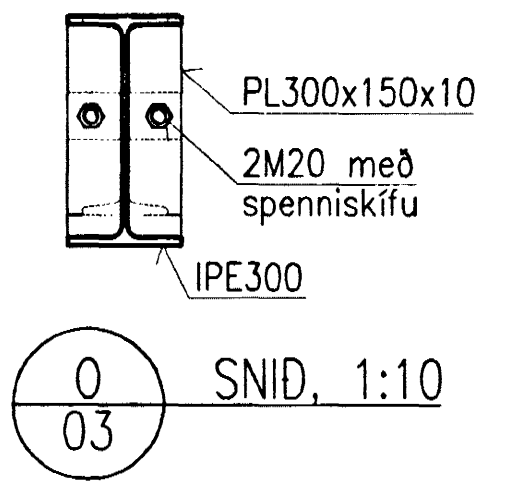
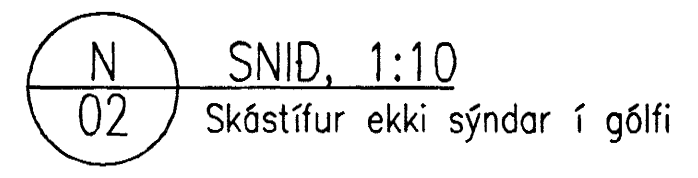
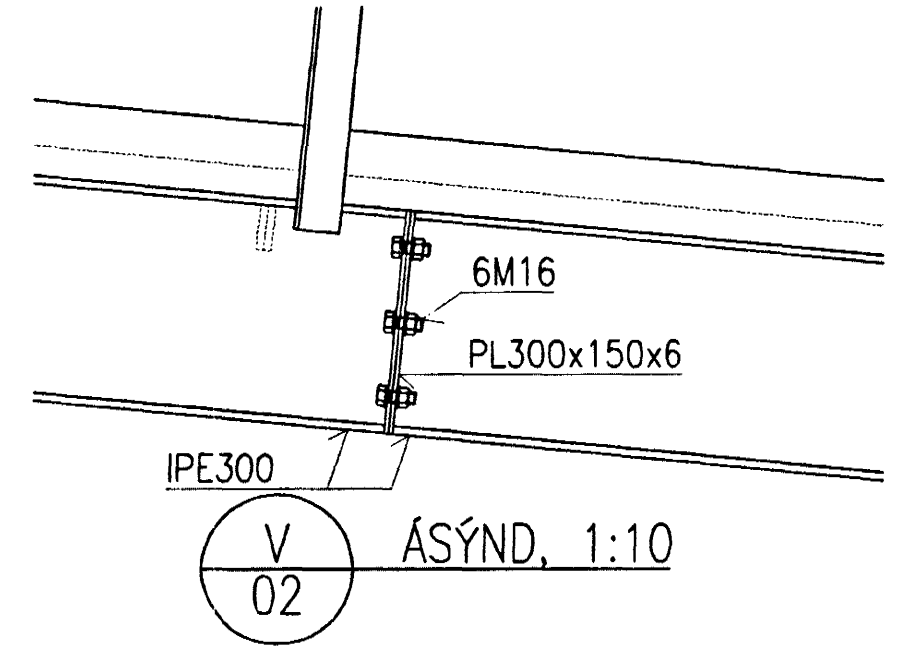
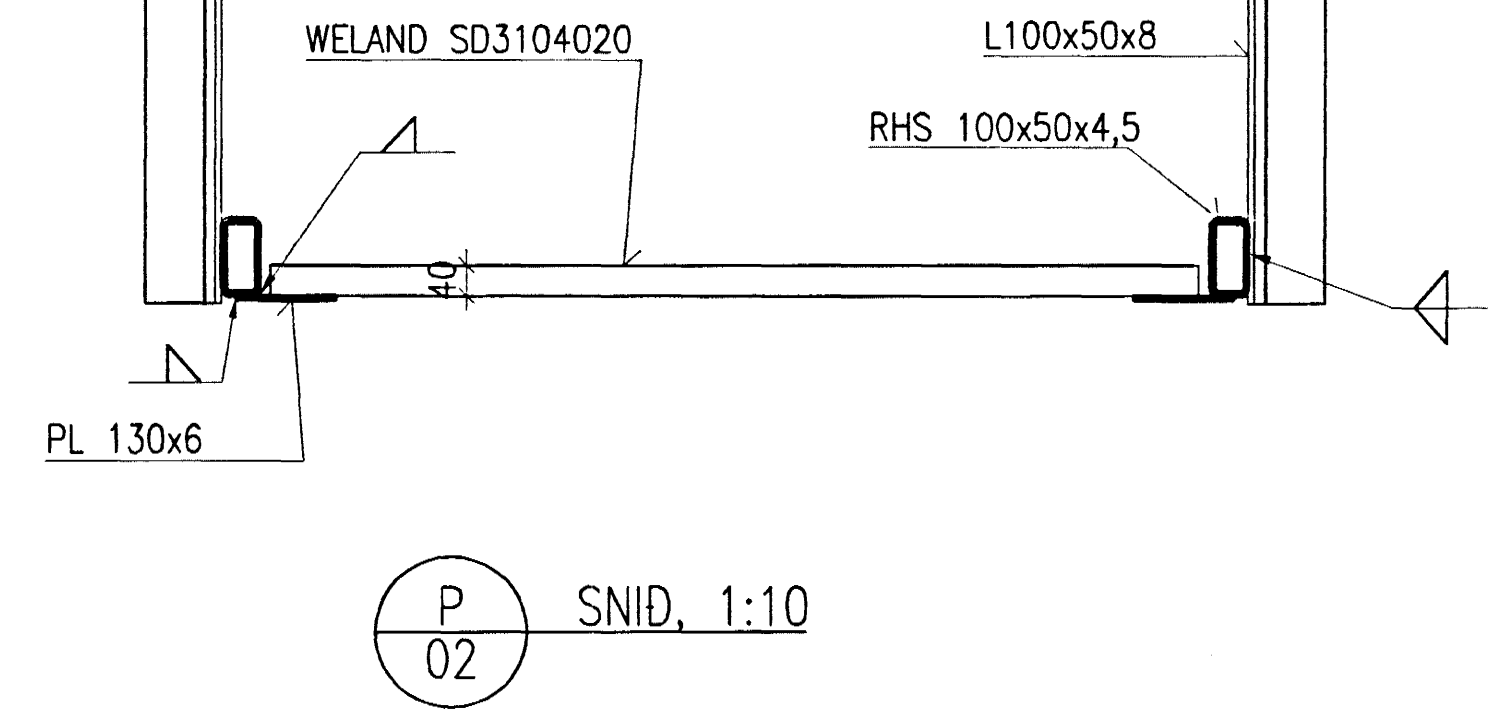
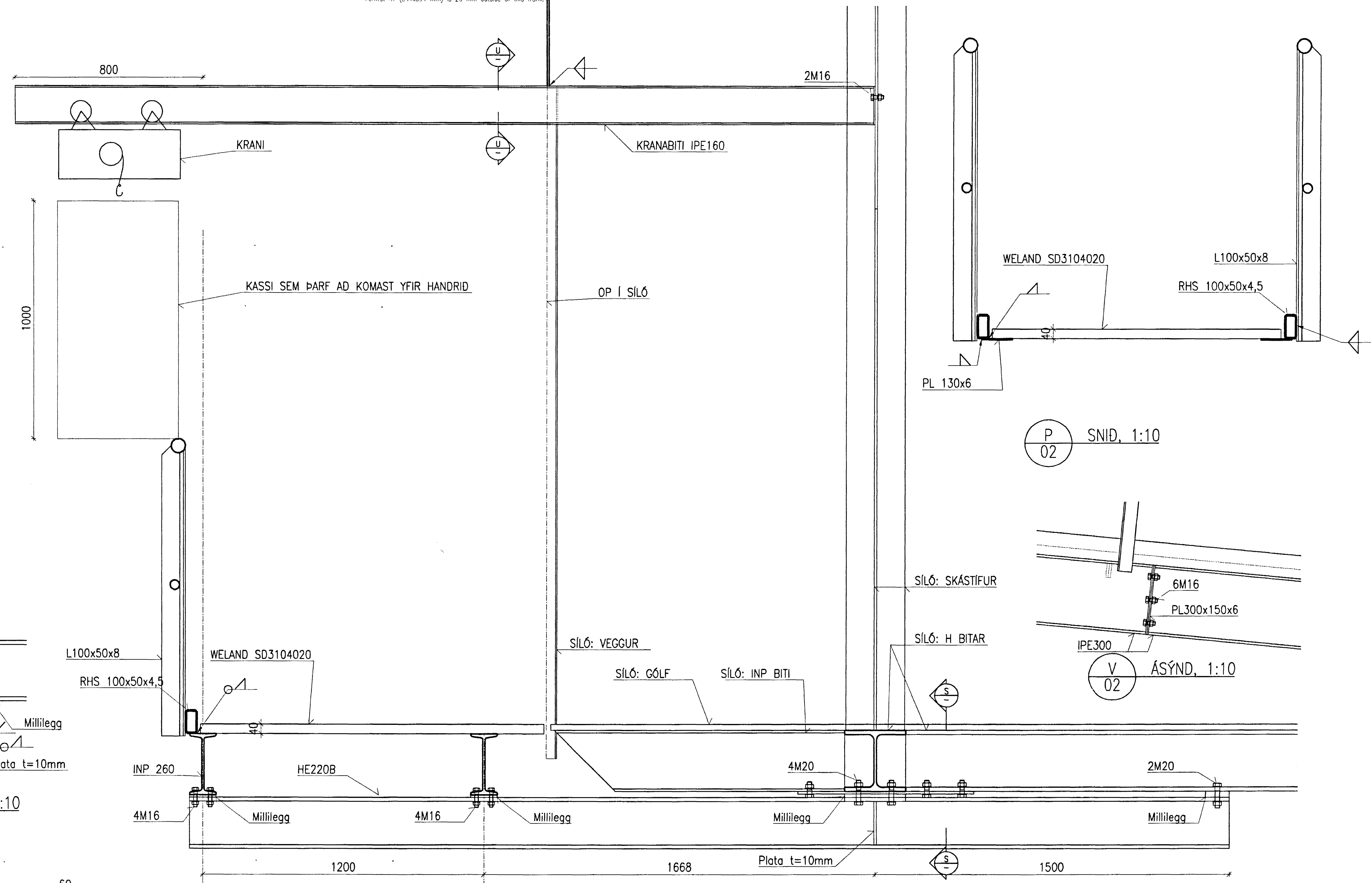

Byggingatillit
Afgreitt þann
25 JULÍ 2002

Skýringar:
Explanations:
Öll mál athugist á staðnum.

This drawing is the property of the ICELANDIC ALUMINIUM CO. LTD. and handed out for personal use only. It may neither be copied nor made available to others without permission of the ICELANDIC ALUMINIUM CO. LTD. The receiver is liable for any misuse.

Fjöldi stykkja	Hútur	Atviki	Efni	eo. stk	totali heild	Athugasemdir
Number of pieces	Object	Item	Material	Weight (kg)	Bygnd	Remarks
IV III II I	DAGSÍLÓ 2, MHL. 06					Málavörð Scale 1:50
	GÖNGUBRÚ ÚT Á KERSKÁLA 1 & 2					Síðar frumteikn. Format of orig. A1
	ÁSÝND, PLÖN OG SNID					C.No. - Eq.type - Eq.no. 5011BA 1250
	Verstak / Supplier					99.110-48.04
Teiknað Drawn	HFB/NI 19.07.2002	Yfirfarið Checked	NI	Sambúið Approved	NI	
	ALCAN PRIMARY METAL GROUP ISAL Alcan Iceland Ltd	Struamavik IS-222 Hafnarfordur	ALCAN			168038
Teiknað Drawn		Virfarið og síkið Checked and filed				Slökun heimúð Released