

Ásynd E-E

Mkv.: 1:50

27270

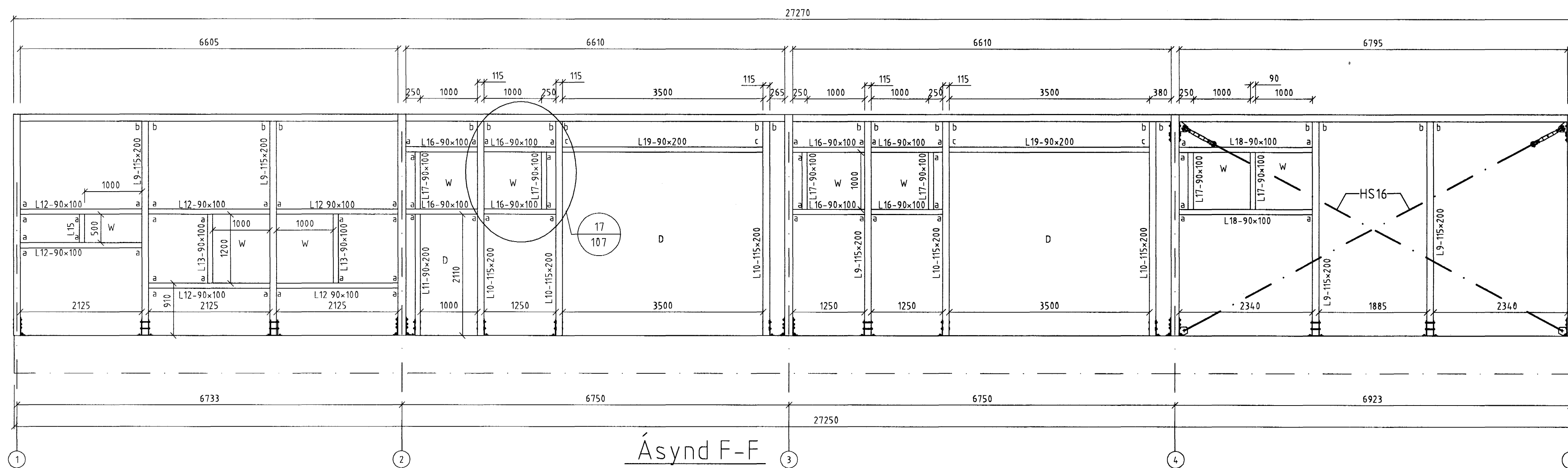
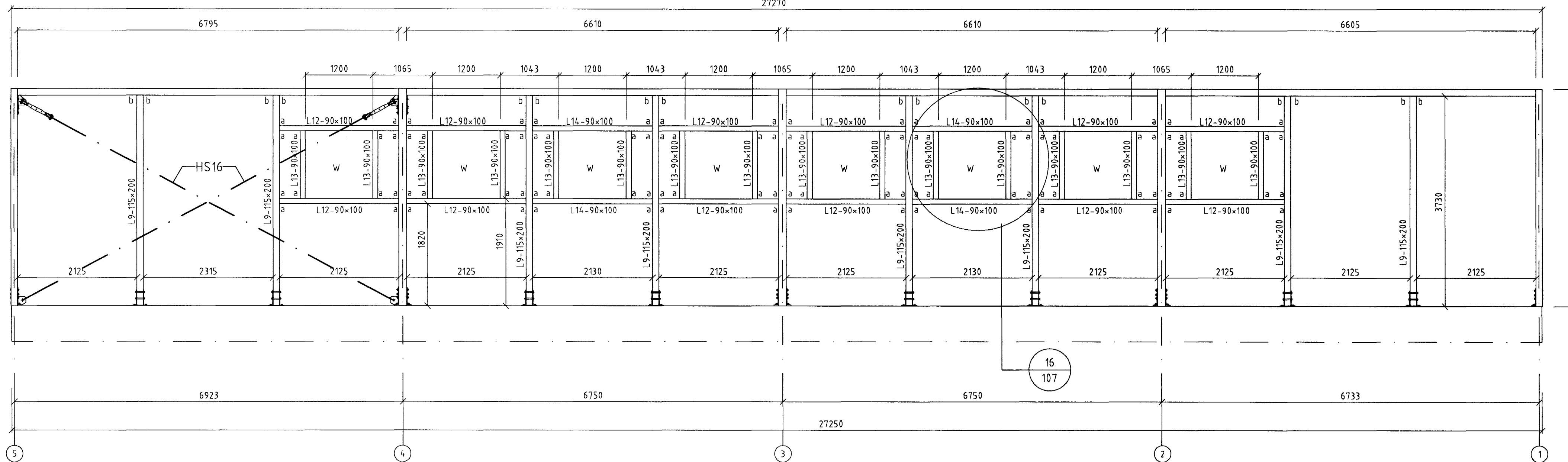

Ásynd F-F

Mkv.: 1:50

Sérmynd 16
Mkv.: 1:25

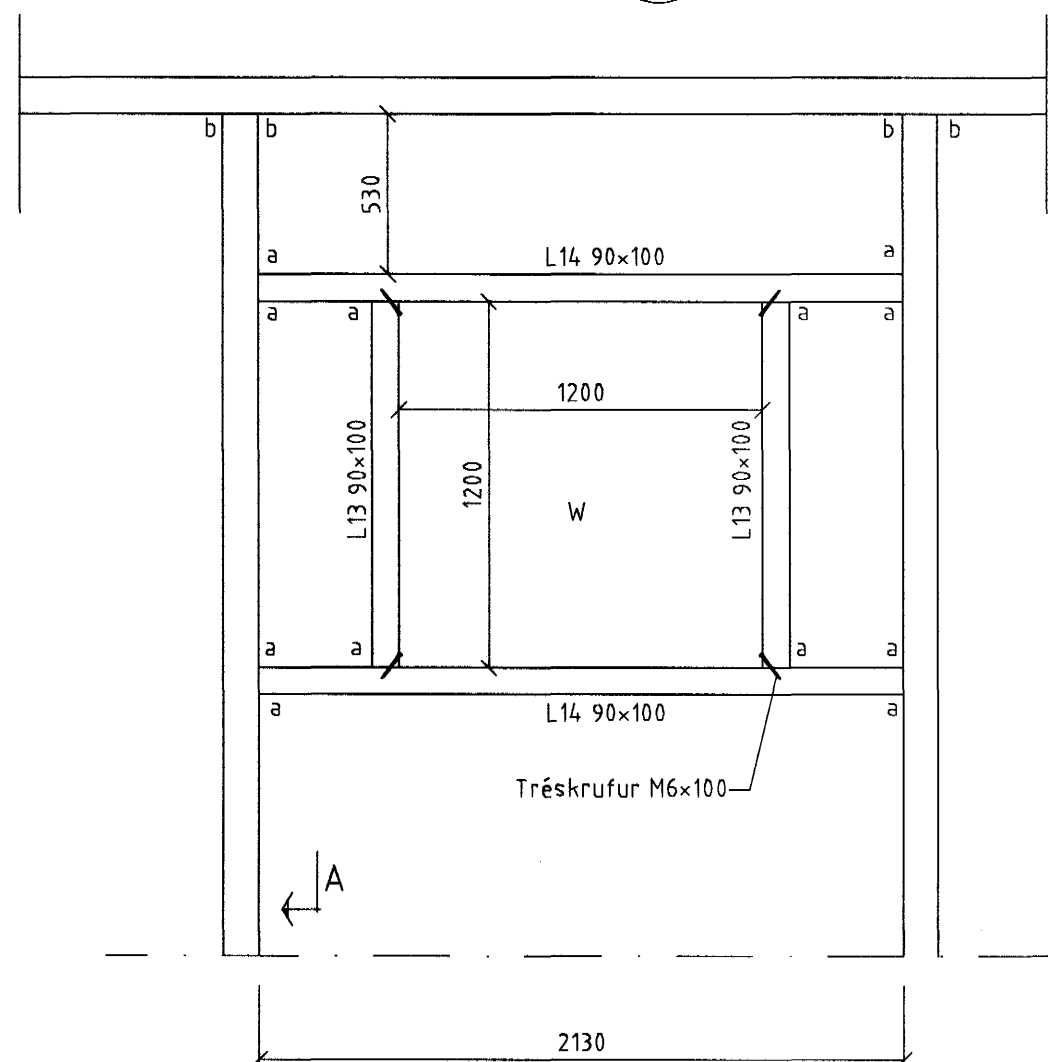

Ásynd A-A

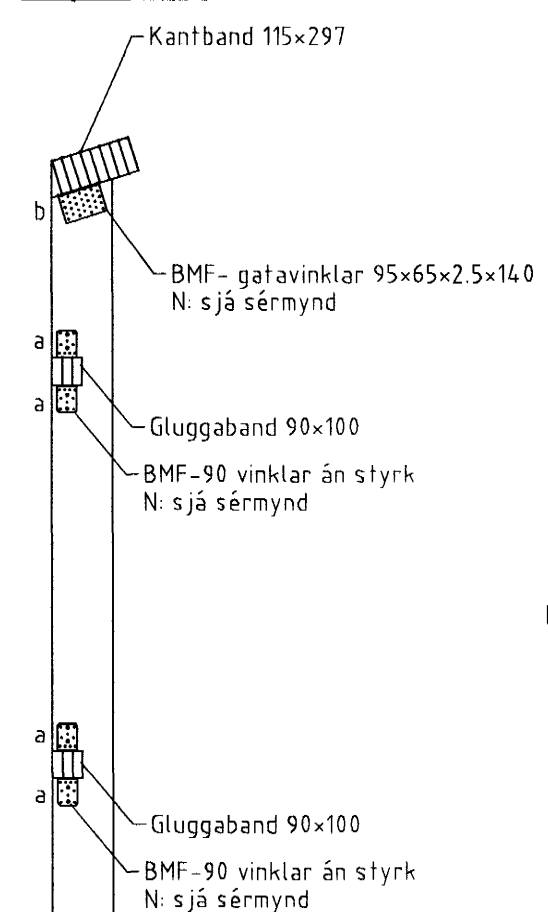

BMF-90 vinklar - a

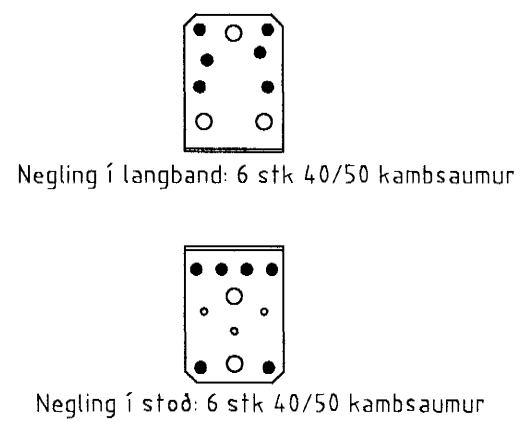

BMF-gatavinklar 95x65x2.5x140 - b

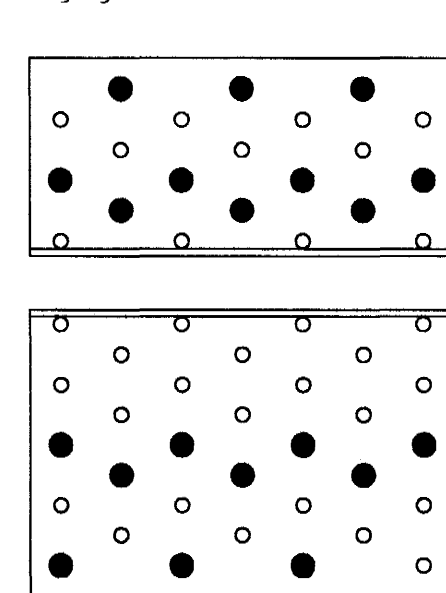

BMF-gatavinklar 95x65x2.5x160 - c

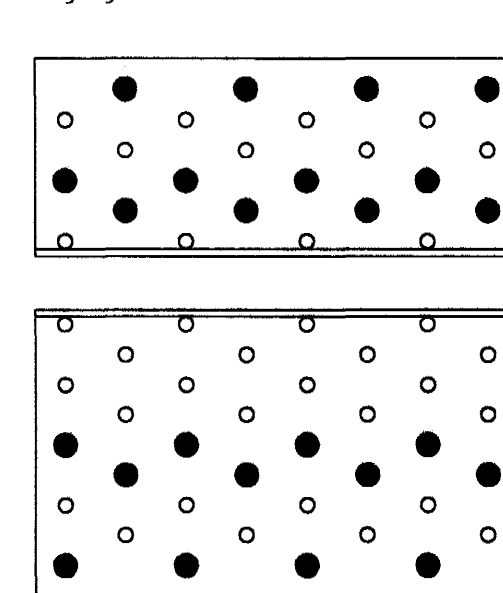

Sérmynd 17
Mkv.: 1:25

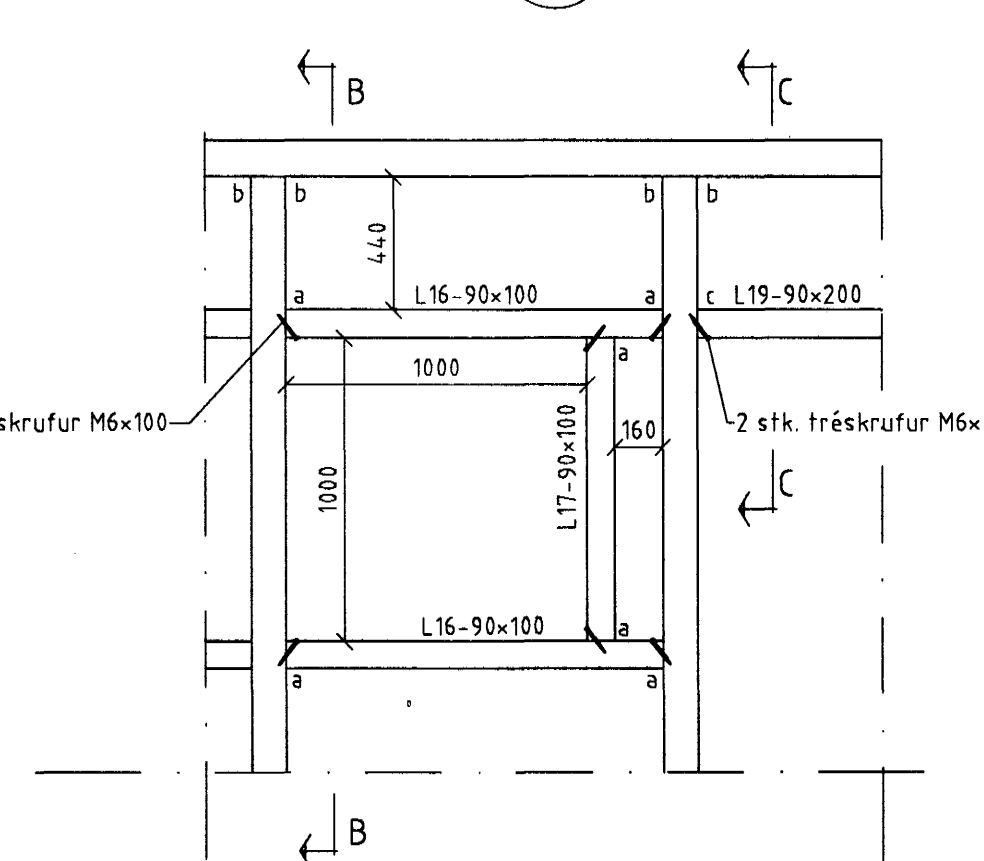

Ásynd B-B

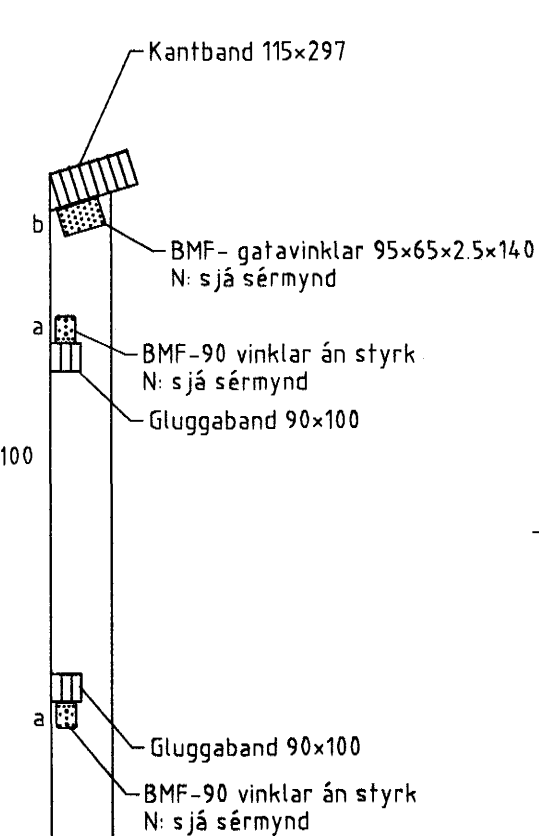

Ásynd C-C

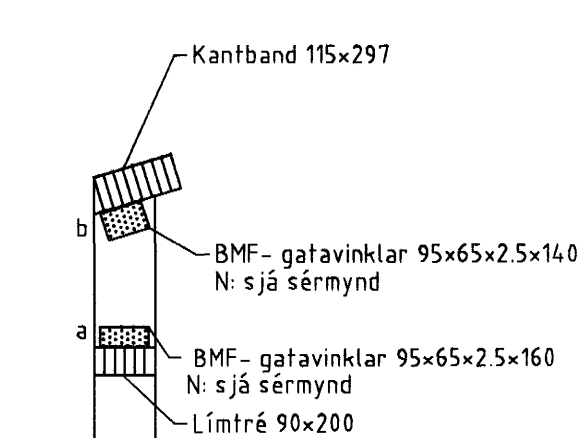

Samþykkt þann
08 DES. 2003
Byggingafrúnn í Hafnarfirði
Eh. Sigurbjartur Halldórsson

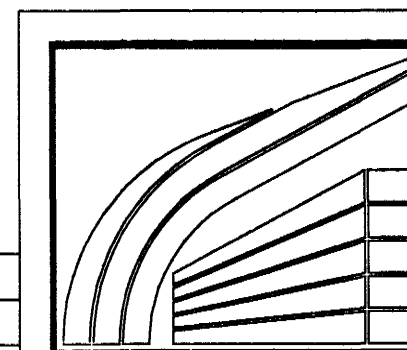

LÍMTRÉ HF.

Takniðeld
Sími: 530 6100 Fax: 530 6019

Hvaleyrarbraut 41, Hafnarfirði

Ásynd E-E og Ásynd F-F

Sérmyndir

TEIKN.	MM	DAGS.	20.07.2000
REIKN.	BI	VERK.	1998080027
YFIRF.		BLAD.	107
MKV.	1:50, 1:25		

Br.			
Br.			
Br.			
Br.			