

G1
HERBERGI 1.H
KARMAR: 50X124
1 STK

H1
ANDDYRI 1.H
BRÉFALÜGA ÚR STÁLI
KARMAR: 50X124
OPNAST INN
1 STK

G3
STOFA 1.H
KARMAR: 50X149
1 STK

H2
STOFA
GLUGGI MED RENNIIHURÐ
SEM OPNAST ÚT TIL HLIÐAR
HORNSTYKKI KLÆTT MED ÁFELLU
KARMAR: 50X149
1 STK

G3
STOFA 1.H
KARMAR: 50X149
1 STK

G4
STOFA 1.H
KARMAR: 50X124
1 STK

H3
BORÐSTOFA 1.H
GLUGGI MED RENNIIHURÐ
SEM OPNAST ÚT TIL HLIÐAR
KARMAR: 50X124
1 STK

G5
ELDHÚS 1.H
KARMAR: 50X124
1 STK

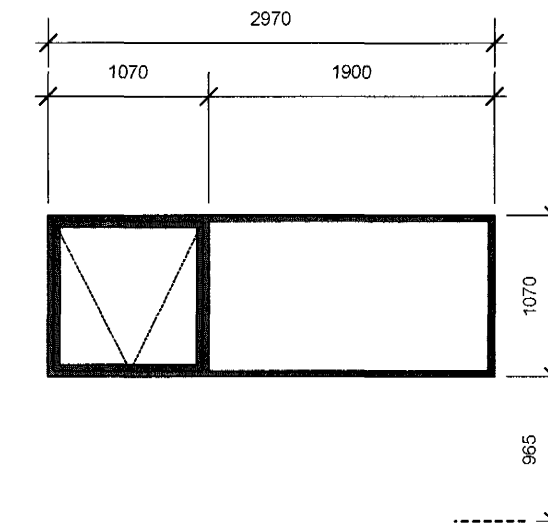
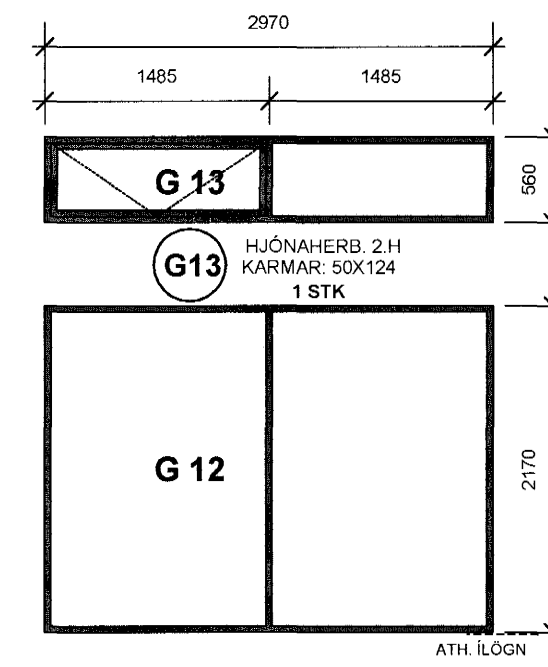
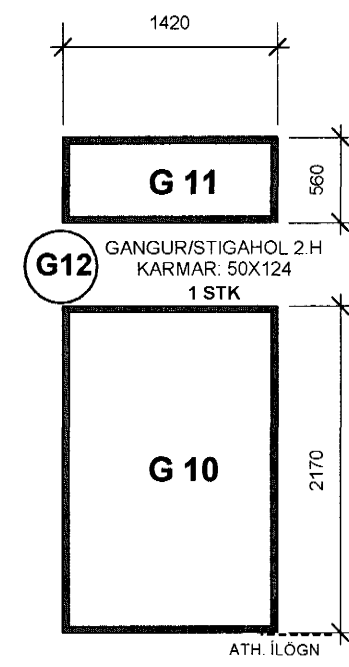
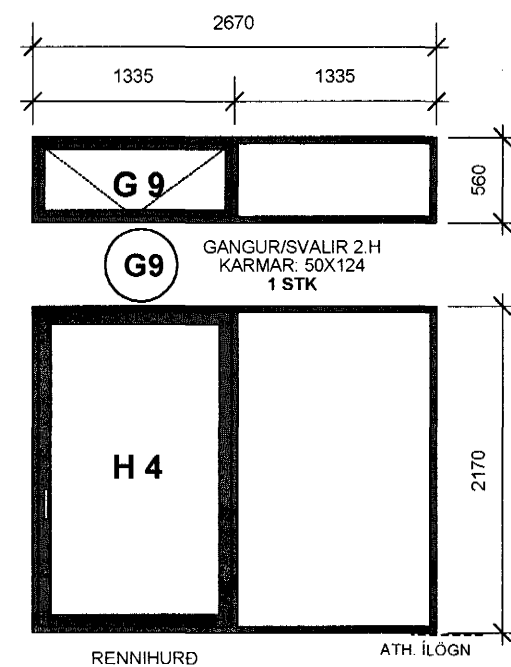
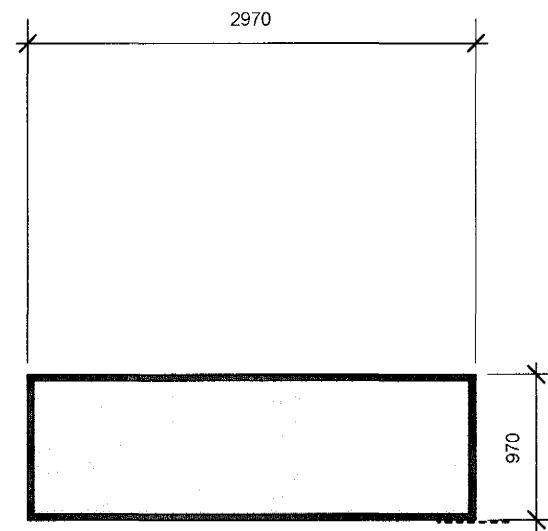
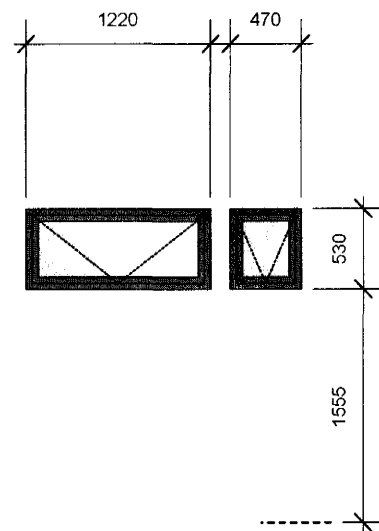

G6
ÞVOTTAHÚS 1.H
SANDBLÁSÍÐ GLER
KARMAR: 50X124
1 STK

G7
BÍLAGEYMSLA 1.H
SANDBLÁSÍÐ GLER
KARMAR: 50X124
1 STK

G8
BÍLAGEYMSLA 1.H
SANDBLÁSÍÐ GLER
KARMAR: 50X124
1 STK

H4
GANGUR/SVALIR 2.H
GLUGGI MED RENNIIHURÐ
SEM OPNAST ÚT TIL HLIÐAR
KARMAR: 50X124
1 STK

G10
GANGUR/STIGAHOL 2.H
KARMAR: 50X124
1 STK

G12
HJÓNAHERB. 2.H
KARMAR: 50X124
1 STK

G14
HJÓNAHERB. 2.H
KARMAR: 50X124
1 STK

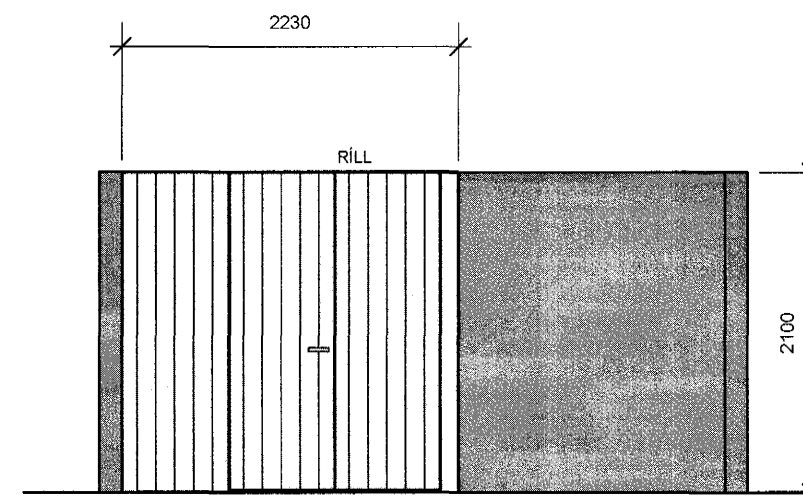
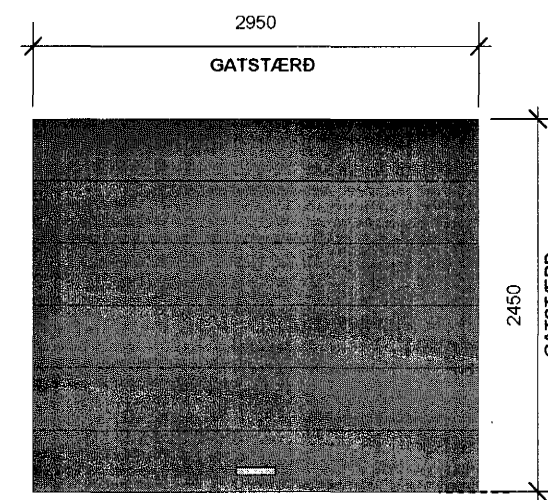
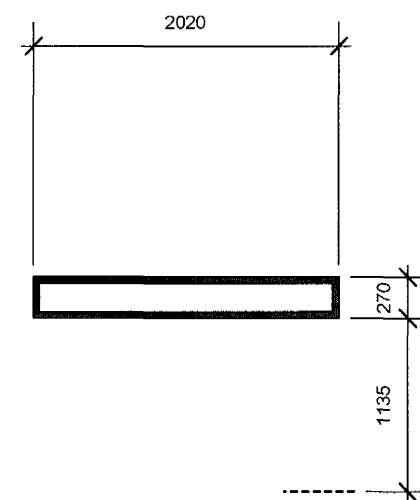
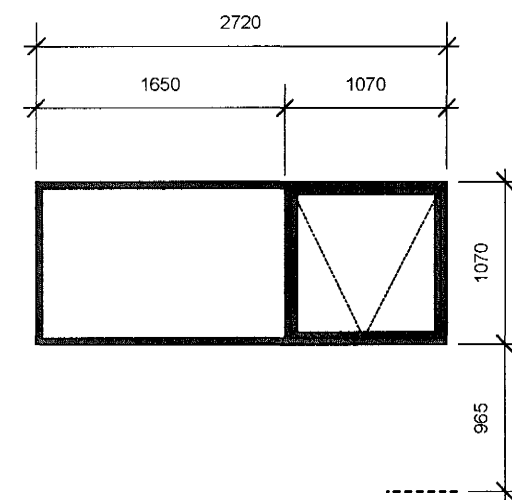
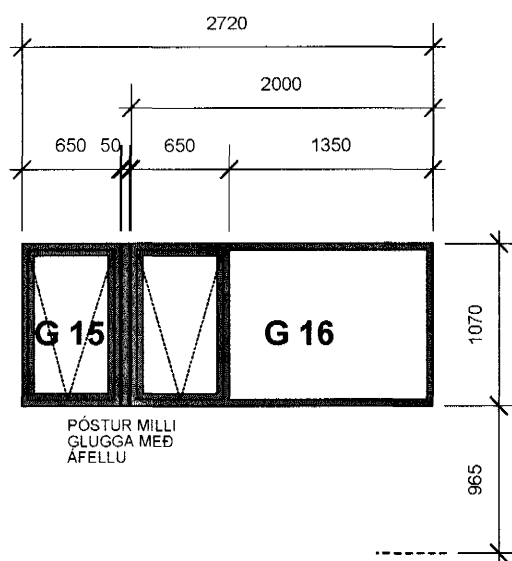

G15
BADHERB. 2.H
EINN FRISTANDANDI,
EINN EINS OG Á MYND
MED PÓST Á MILLI GLUGGA
MED ÁFELLU
KARMAR: 50X124
2 STK

G16
HERBERGI 2.H
KARMAR: 50X124
1 STK

G17
HERBERGI 2.H
KARMAR: 50X124
1 STK

G18
HERBERGI 2.H
KARMAR: 50X124
1 STK

H5
BÍLAGEYMSLA
ÁLFELLIHURÐ MED
SLÉTTI ÁFERÐ
1 STK

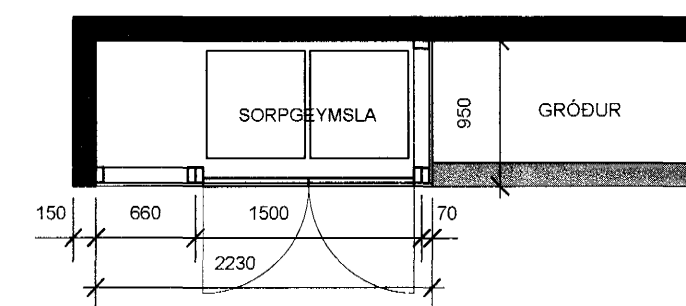

H6
SORPGEYMSLA
TRÉKARMAR OG HURÐIR
HURÐIR KLÆDDAR MED SAMSV.
KLÆDNINGU OG Á HÚSI
KARMAR: 50X115
1 STK

SKÝRINGAR
UPPGERIN MÁL ERU SMÍÐAMÁL; SAMRÆMIST VIÐ FRÁGANG FRAMLEIÐANDA.
GLUGGAR OG HURÐIR ERU SETTAR Í EFTIR UPPSTEYPU HÚSS.
GLUGGAR ERU SAMSETTIR ÁL- OG TIMBURGLUGGAR.
HURÐ Í BÍLAGEYMSLU ER ÁLFELLIHURÐ MED INNBRENDUM LIT OG SLÉTTI ÁFERÐ. LITUR: RAL 7015
HURÐ FYRIR SORPGEYMSLU SMÍÐAST ÚR TIMBRI MED VIÐARKLÆDNINGU.
OPNALEG FOG ERU ÖLL TOPPHENGÐ.
FRÁGANGUR SAMKVÆMT FYRIRSÖGN FRAMLEIÐANDA.
PÓSTASTÆRÐ REIKNAST ÚT FRÁ GLUGGASTÆRÐ OG VINDÁLAGI; SJÁ TEIKNINGAR VERKFRÆÐINGA.
GLER SKAL VERA A.M.K. K-GLER.
SÖLSTOPP-GLER SKAL VERA Í GLUGGUM Á SUÐUR OG VESTURHLIÐ.
LITUR:
- ÁL AÐ UTAN: RAL 7021
- TIMBUR AÐ INNAN: RAL 7021

ATH.
ÖLL MÁL ERU Í MM
TEIKNING ER AÐEINS LEIÐBEINANDI
ÖLL MÁL TAKIST Á STAÐNUM FYRIR SMÍÐI
MISRÆMI Í TEIKNINGUM TILKYNNIST ARKITEKTUM STRAX

BREYTINGAR:
10. '02: Kjallaragluggi fjarlægður.
Byggingaúthlitið má
álgreint þessi
06 NOV. 2002

BLÓMVELLIR 6	HAFNARFJÖRÐUR	2.09
SÉRUPPDRÁTTUR	Glugga- og Hurðayfirlit	Dags. 10. '02
		M.kv: 1:50

Gunnar Páll Kristinnsson arkitekt
RÝMA ARKITEKTAR Klappargötu 25, 101 Reykjavík kt: 260665-3679
sími: 552 9515 fax: 562 1655 gsm: 698 5865 netfang: gunnarpall@tal.is
Gunnar Páll Kristinnsson 090462-2297