

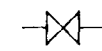

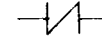

-  RENDILOKI
-  EINSTREYMISSLOKI
-  SÍA
-  HEMILL
-  MÆLIR
-  ÞRÝSTIJAÐDARI
-  ÞRÝSTIMÆLIR
-  HITAMÆLIR
-  TÆMINGARLOKI

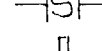
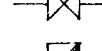
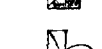

Verðir húsir hafa upp til fróðabrigða, með ofskynaditum og öðrum hlutum, skal hafi fyllt skemmtu um byggingarhættu og slökkviliðstöðu um frógang slúka tilbúnaðar.

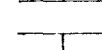
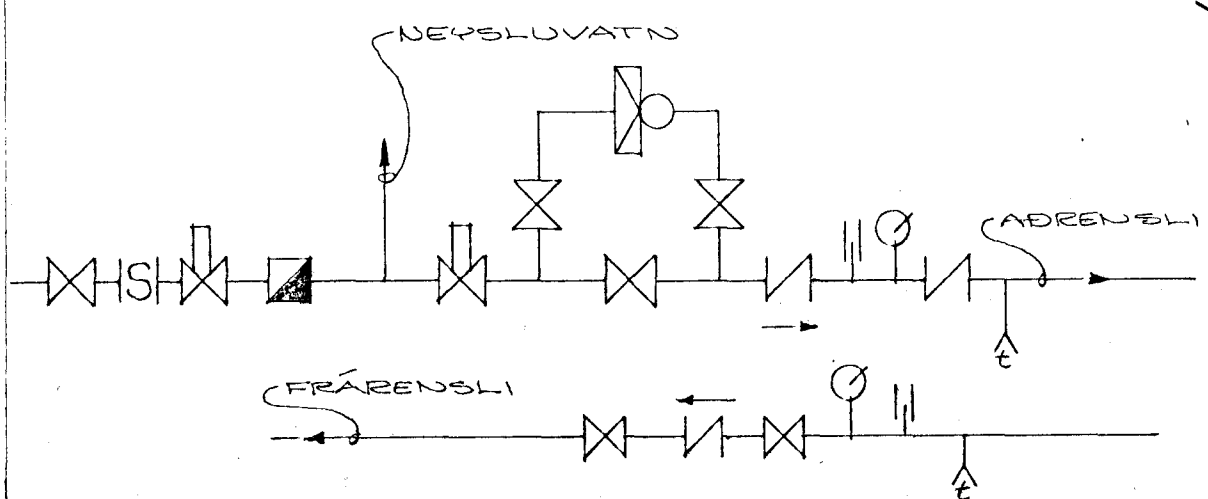
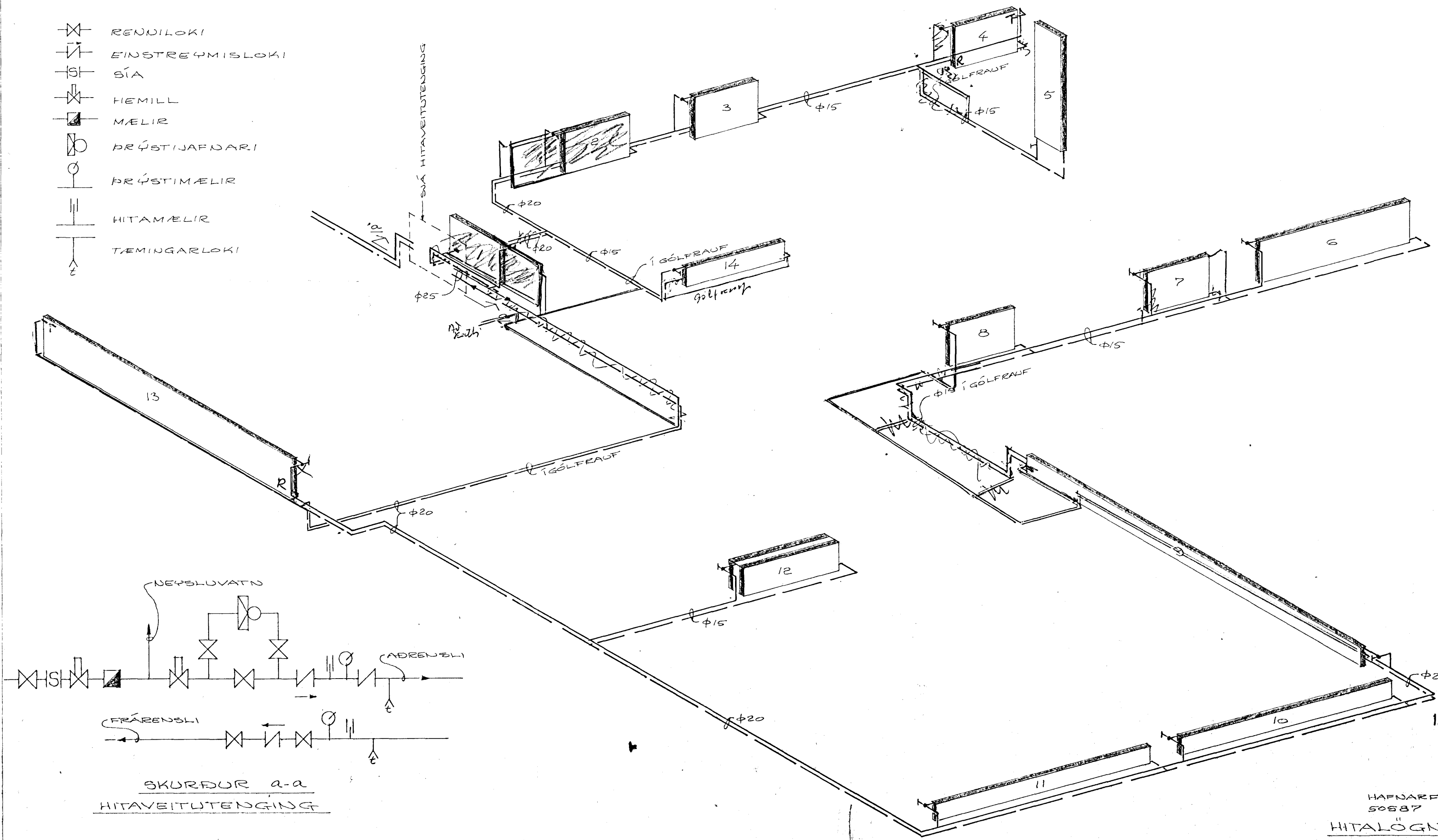
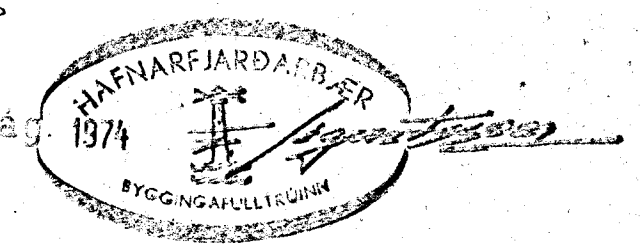

HAFNARFIRÐI Í JÚLI 1974  
50587  
HITALÖGN - RÚMMYND  
Sýna Magnússon, M.F.