

Samþykkt á fundi bygginga-
nefndar þ. 4. 4. 1945
BYGGINGAFULLTRÚINN
I HAFNARFIRÐI
J. h. Steinarð.

Jóhannes Karlsson og 2 D. g.
Breyting á húsinu nr. 7 við Hellisgötu, Hafnarfirði.

Þyrr breytingu

Samþykkt á fundi bygginga-
nefndar þ. 19. 7. 1920
BYGGINGAFULLTRÚINN
I HAFNARFIRÐI
J. h. Steinarð.

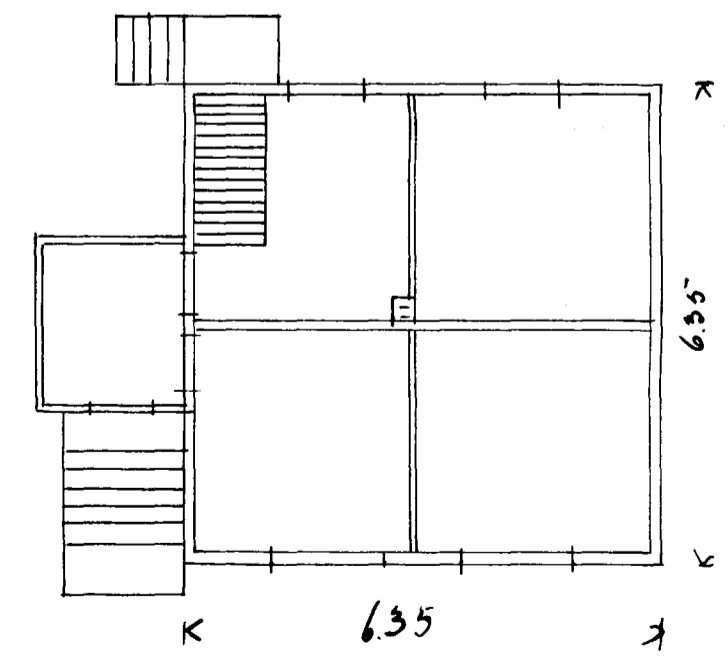
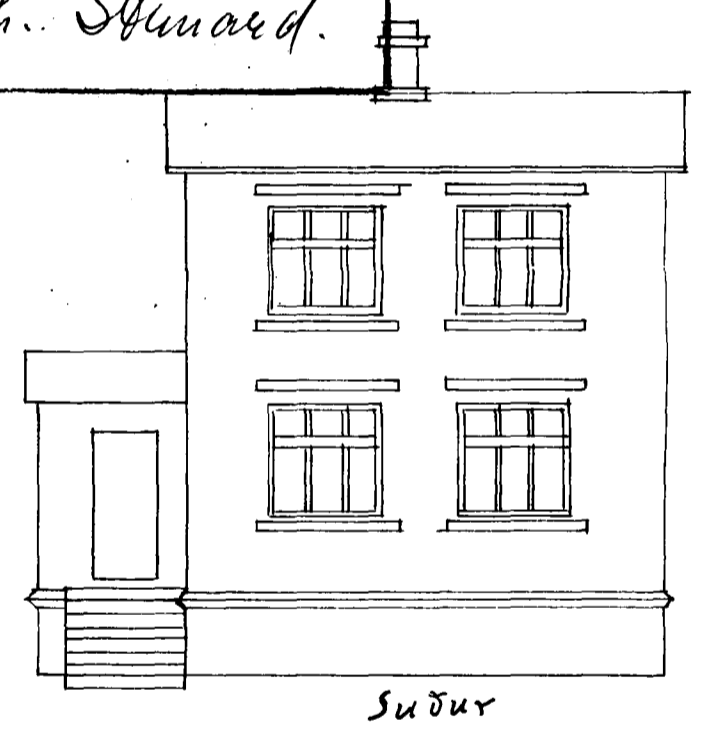

Eftir breytingu

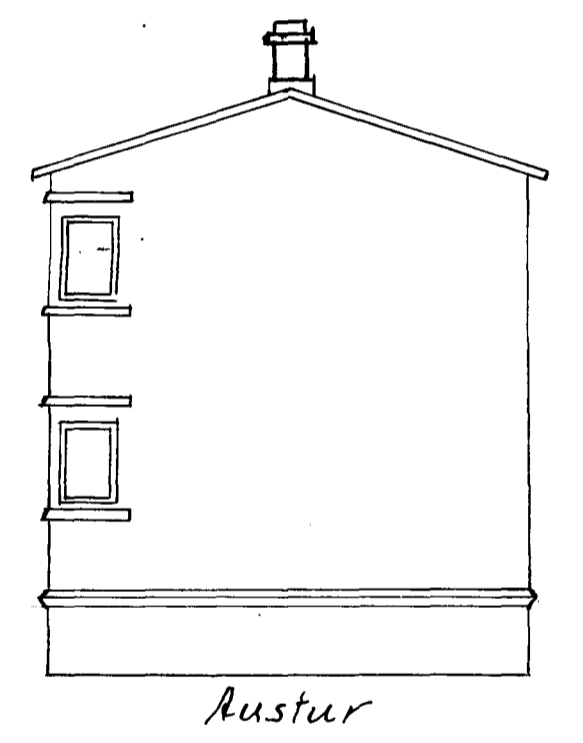
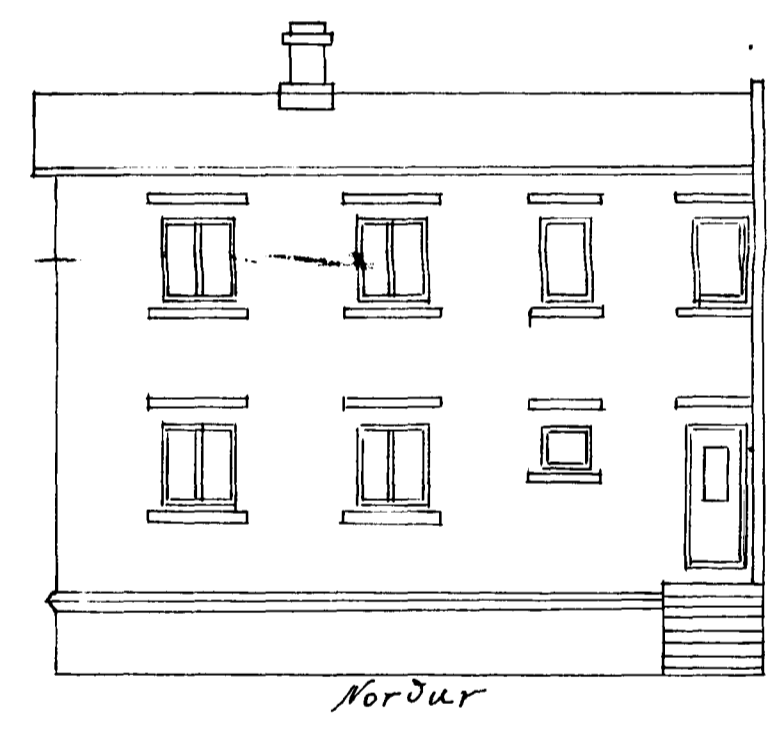
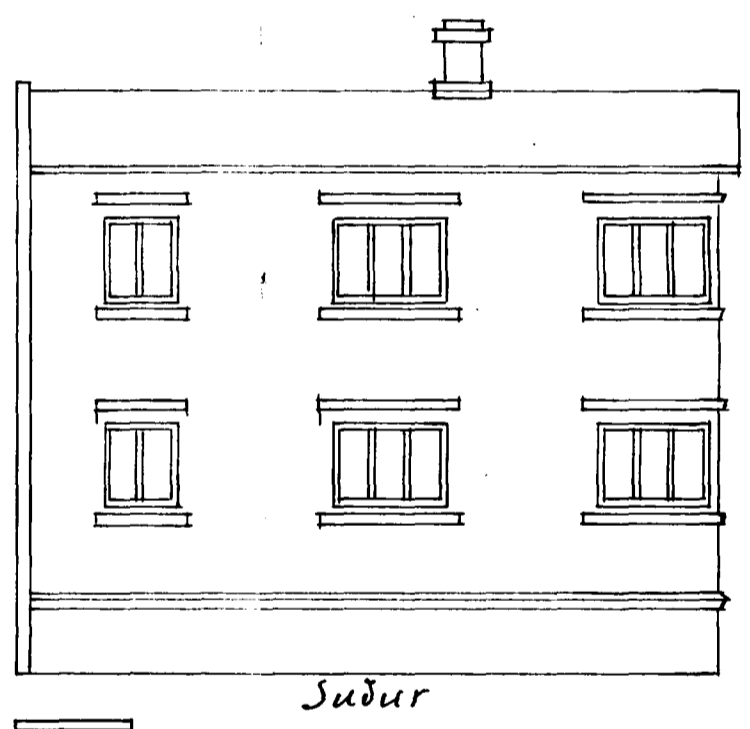
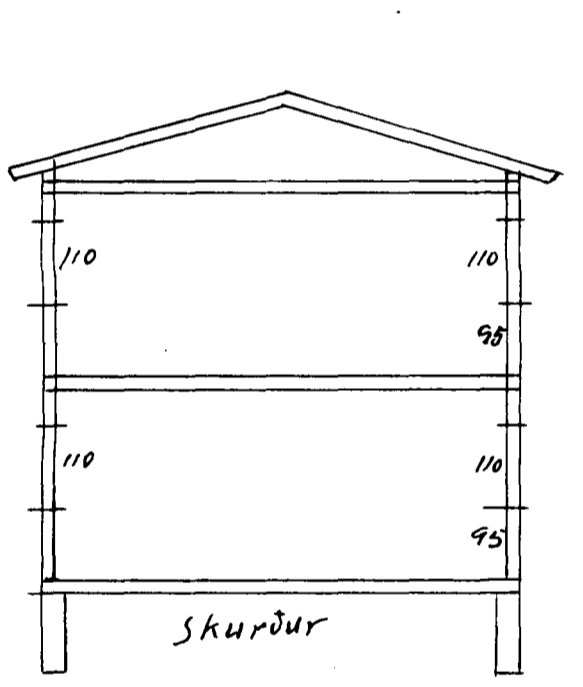

kvarði 1:100

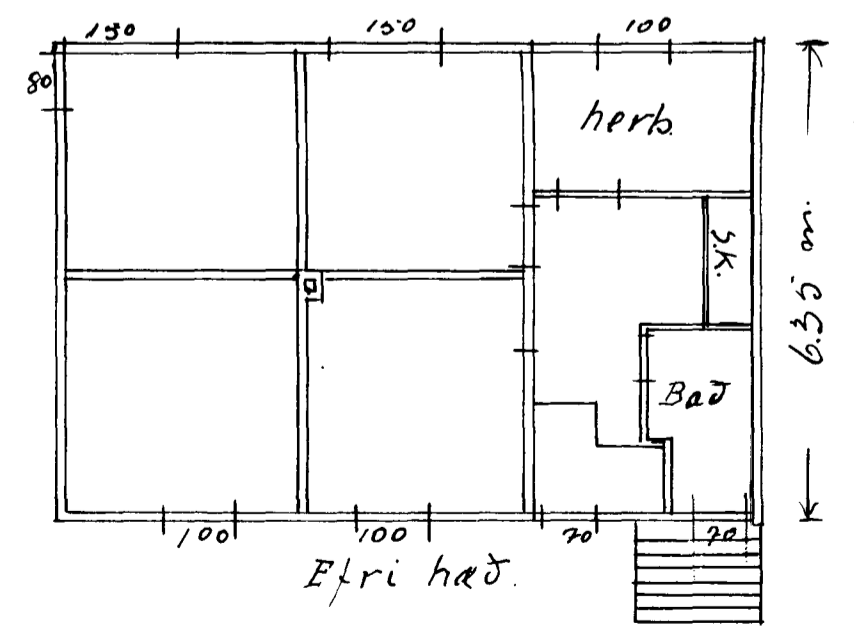
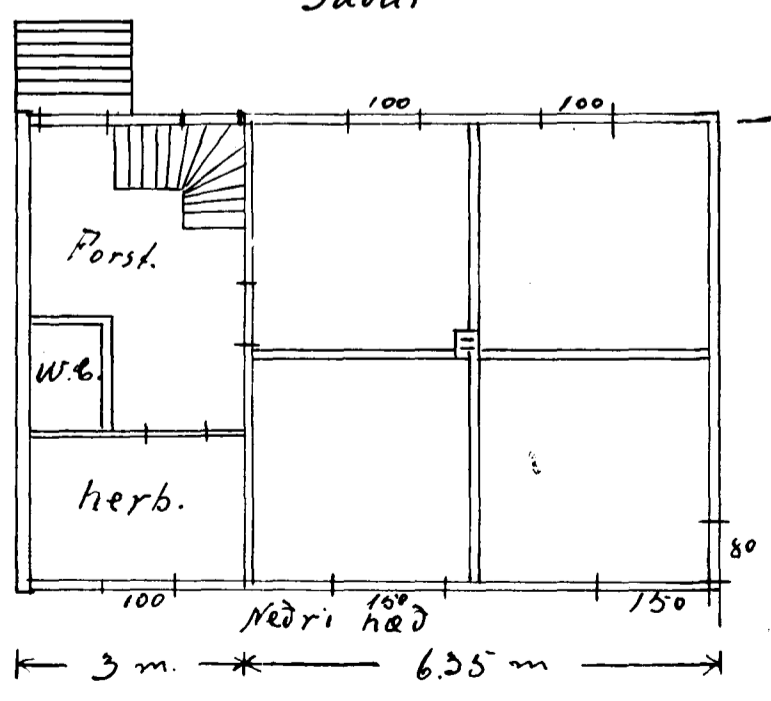

*Hafnarfirði í apr. 1945
Prestur M. Gunnarsson*