

GLUGGAR FYRIR BREYTINGU

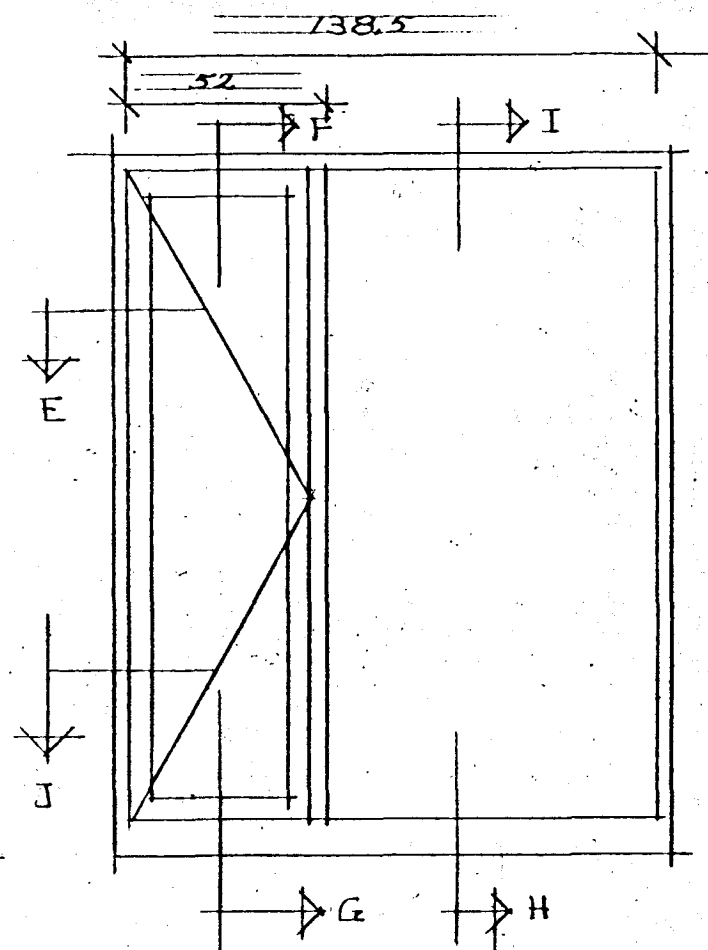

GLUGGAR EFTIR BREYTINGU

Öll mál takist á staðnum.

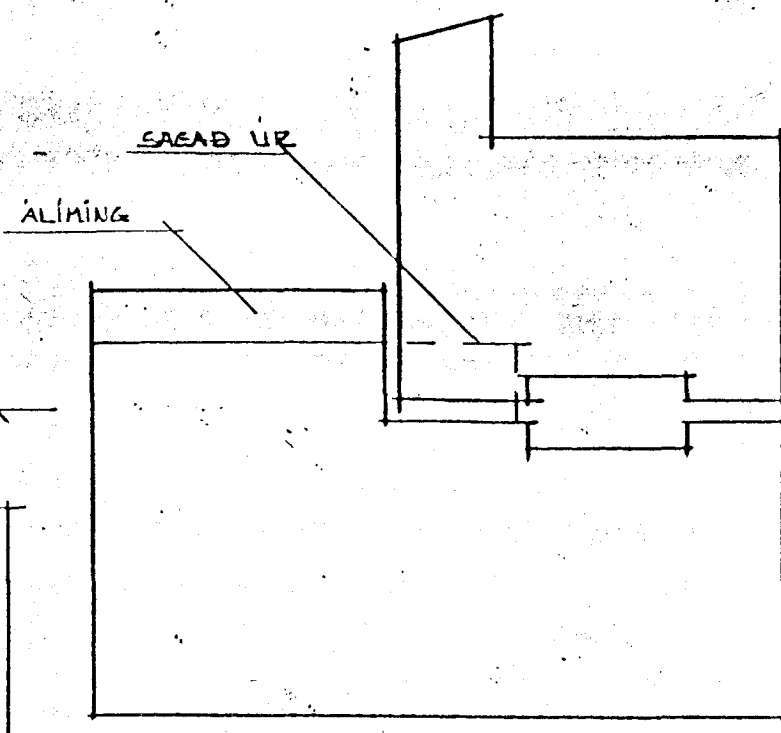

HLUTAMYND J

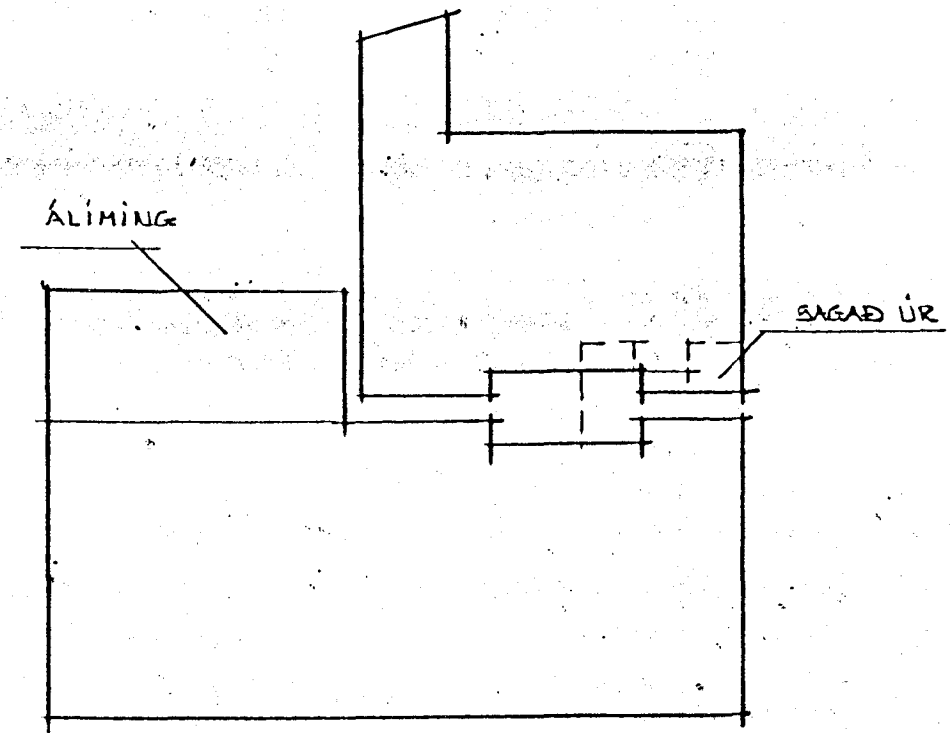

HLUTAMYND E

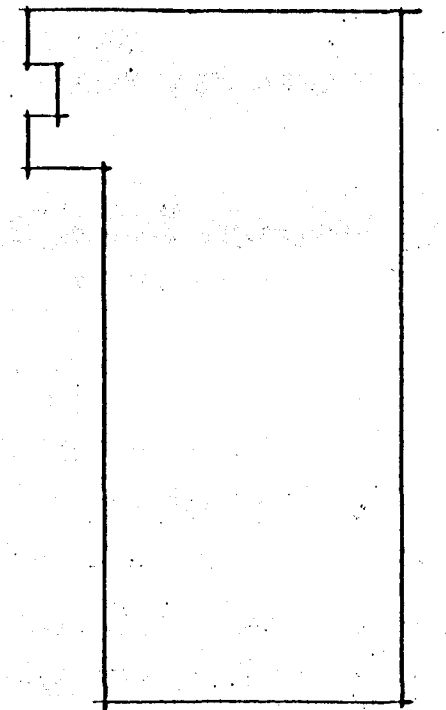

HLUTAMYND C

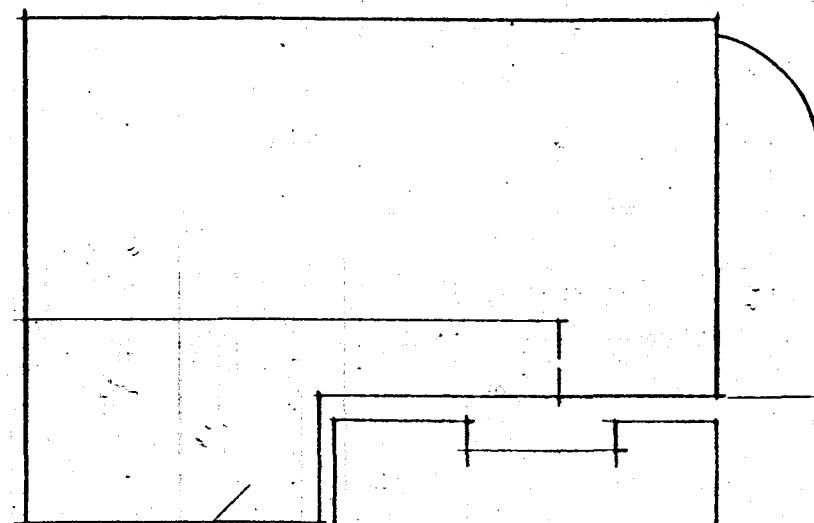

HLUTAMYND F

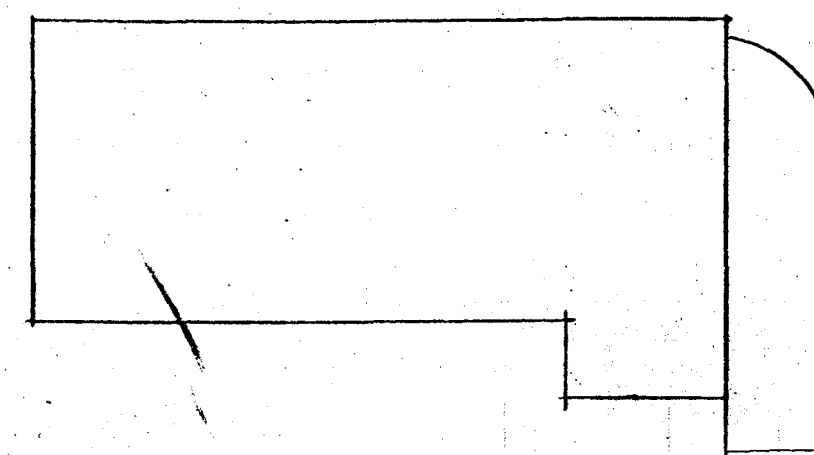

HLUTAMYND B

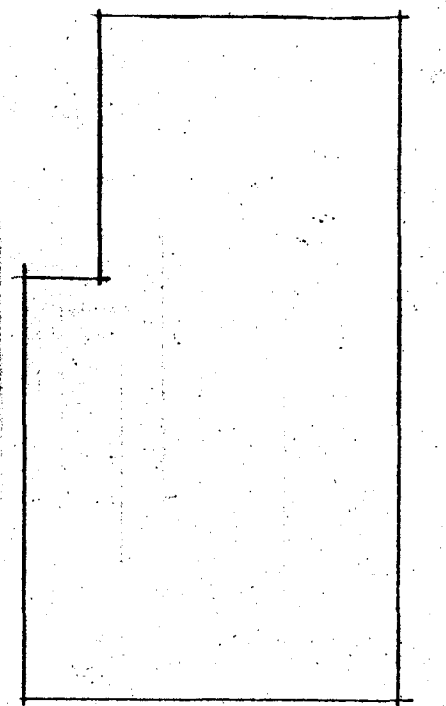

HLUTAMYND D

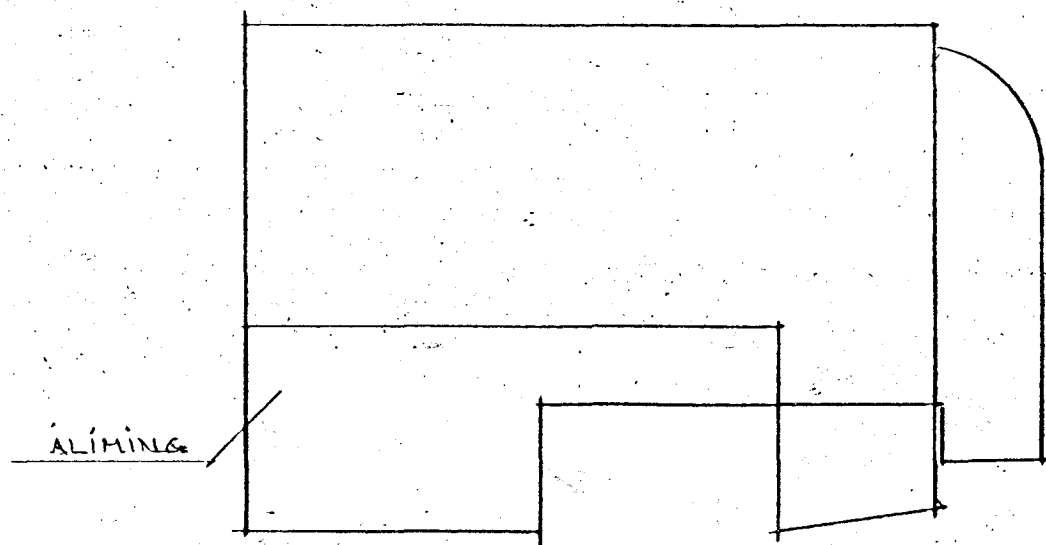

HLUTAMYND I

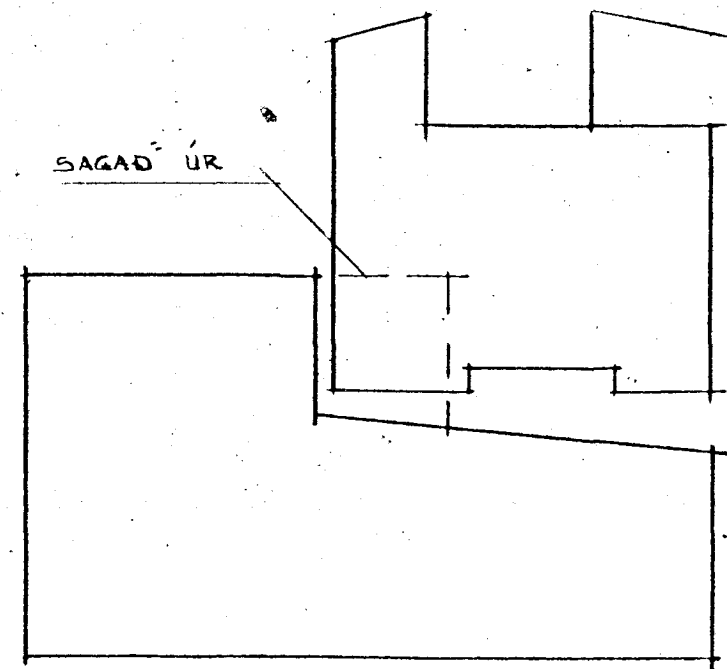

HLUTAMYND G

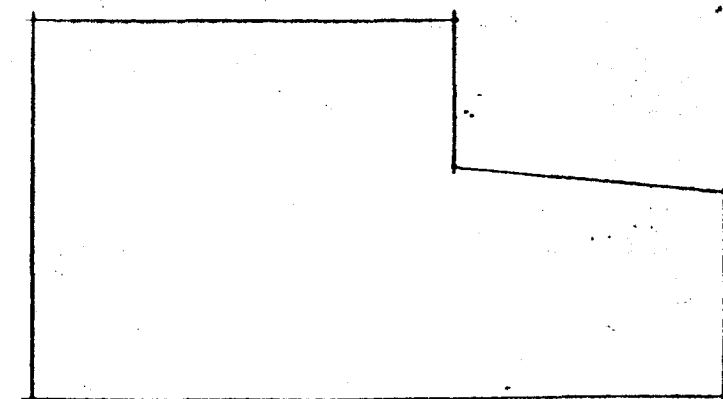

HLUTAMYND A

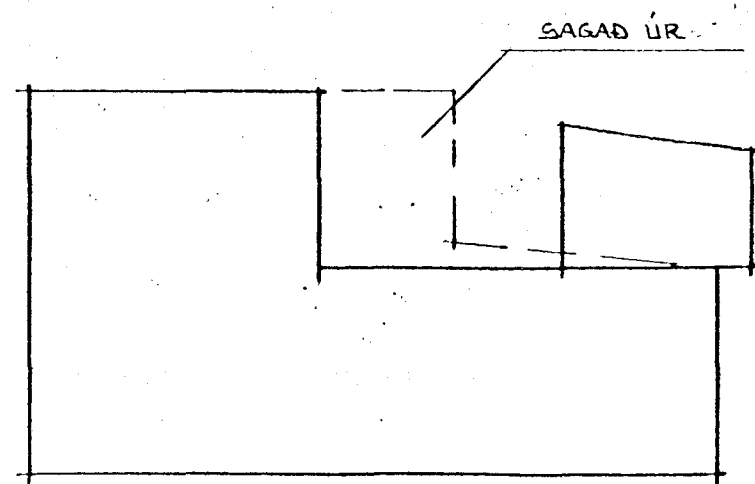

HLUTAMYND H

Hlutamyndir eru gerðar eftir mælingar á staðnum, komi í ljós einhver vafaatriði skal haft samráð við hönnuð.

Á sérteikningum eru sýndar þær aðgerðir sem gera þarf, þ.e. líma á núv. glugga, fræsa eða saga úr núv. gluggum. Á opnanlega glugga skal setja 3ja punkta læsingarjárn.

Öll mál takist á staðnum. 11 JUNI 1998

Byggingarátt. Arnar Hálmarráðar
Afgreitt þann
Sigurbjartur Halldórsson
Sigurbjartur Halldórsson

4. HÍ. 1998-82. VIÐVAGA Á SUBURHÍÐ