

Gluggi við geymslur

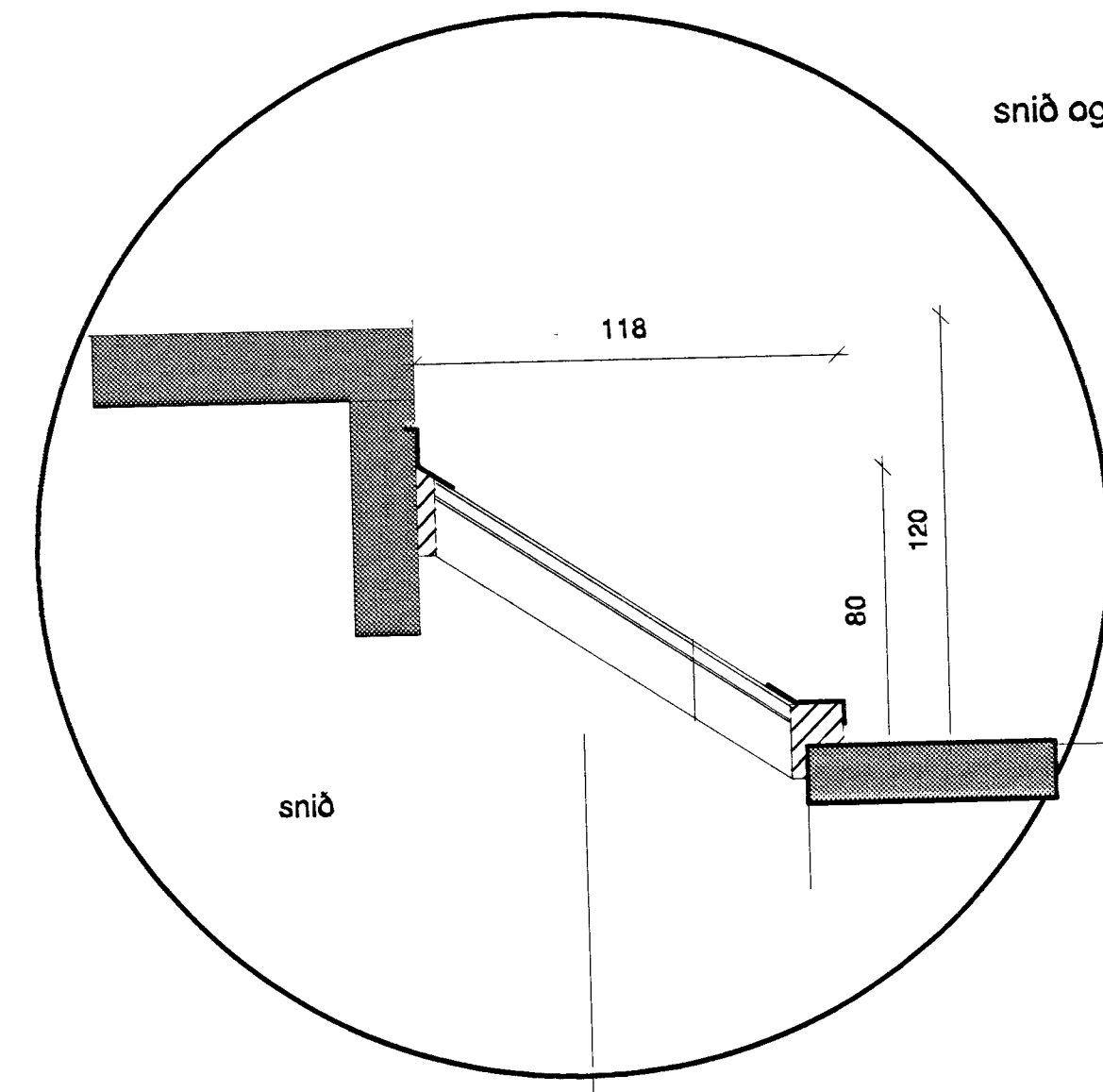

snið og útlit af glugga við geymslur 1 : 20

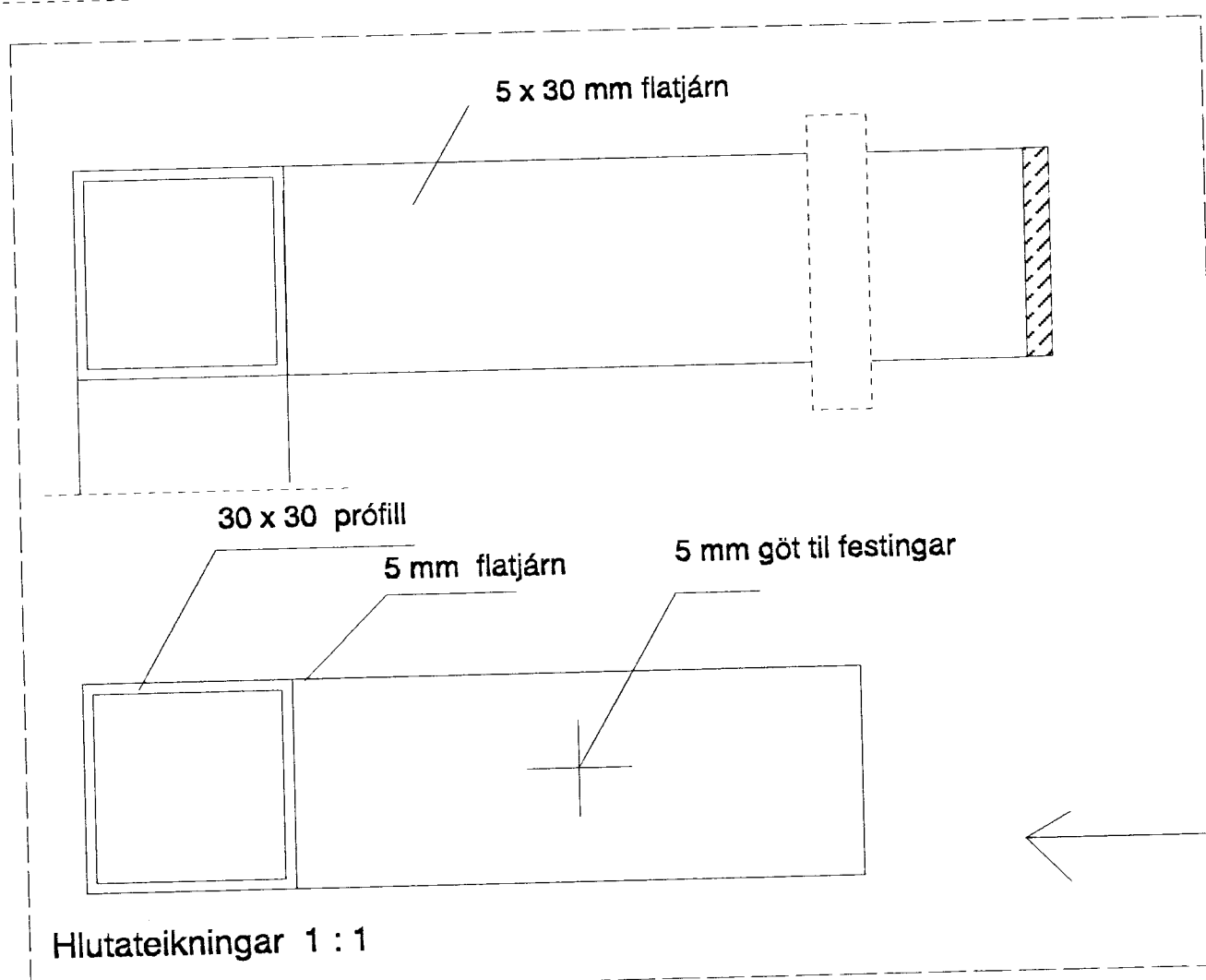
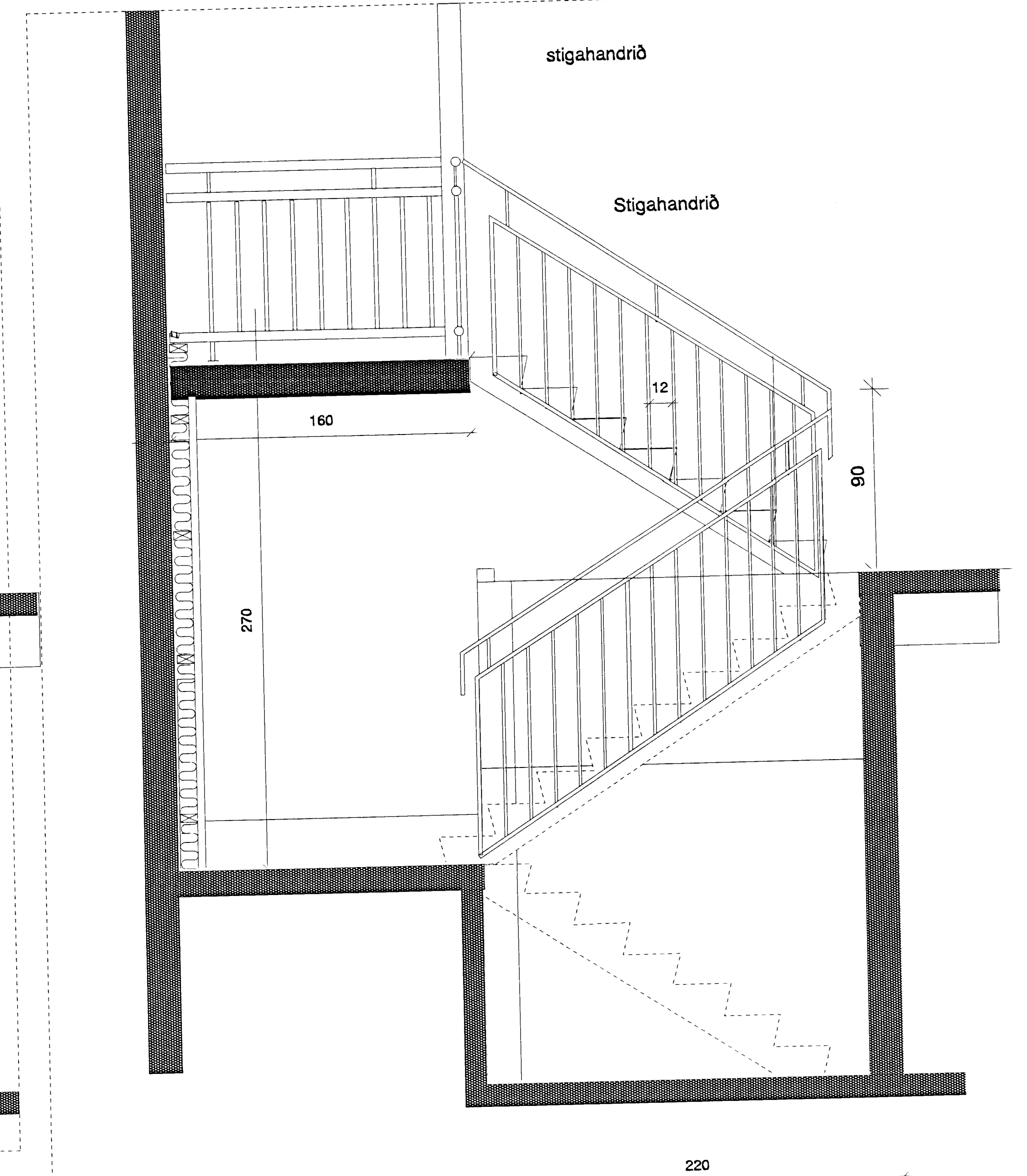
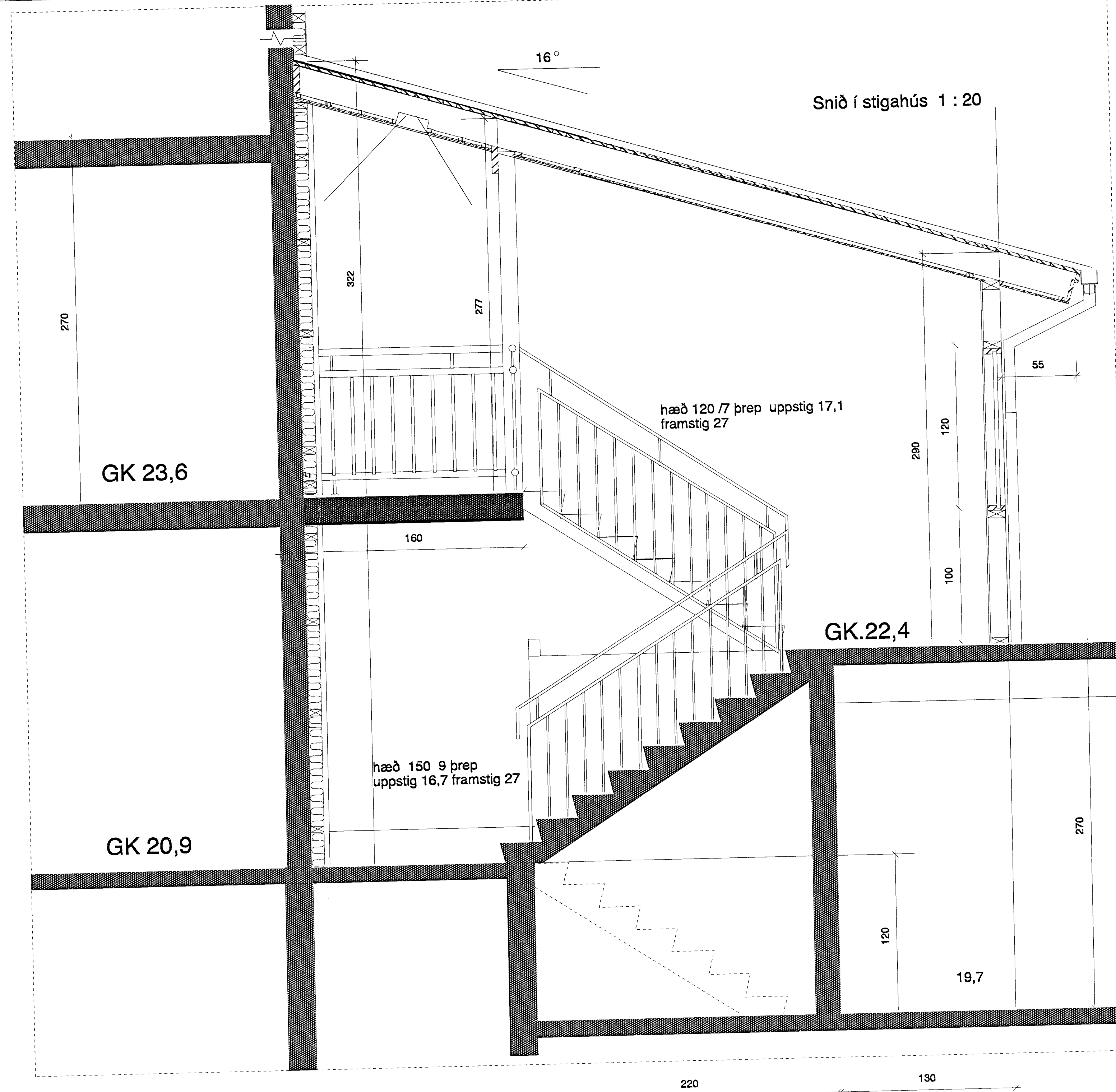
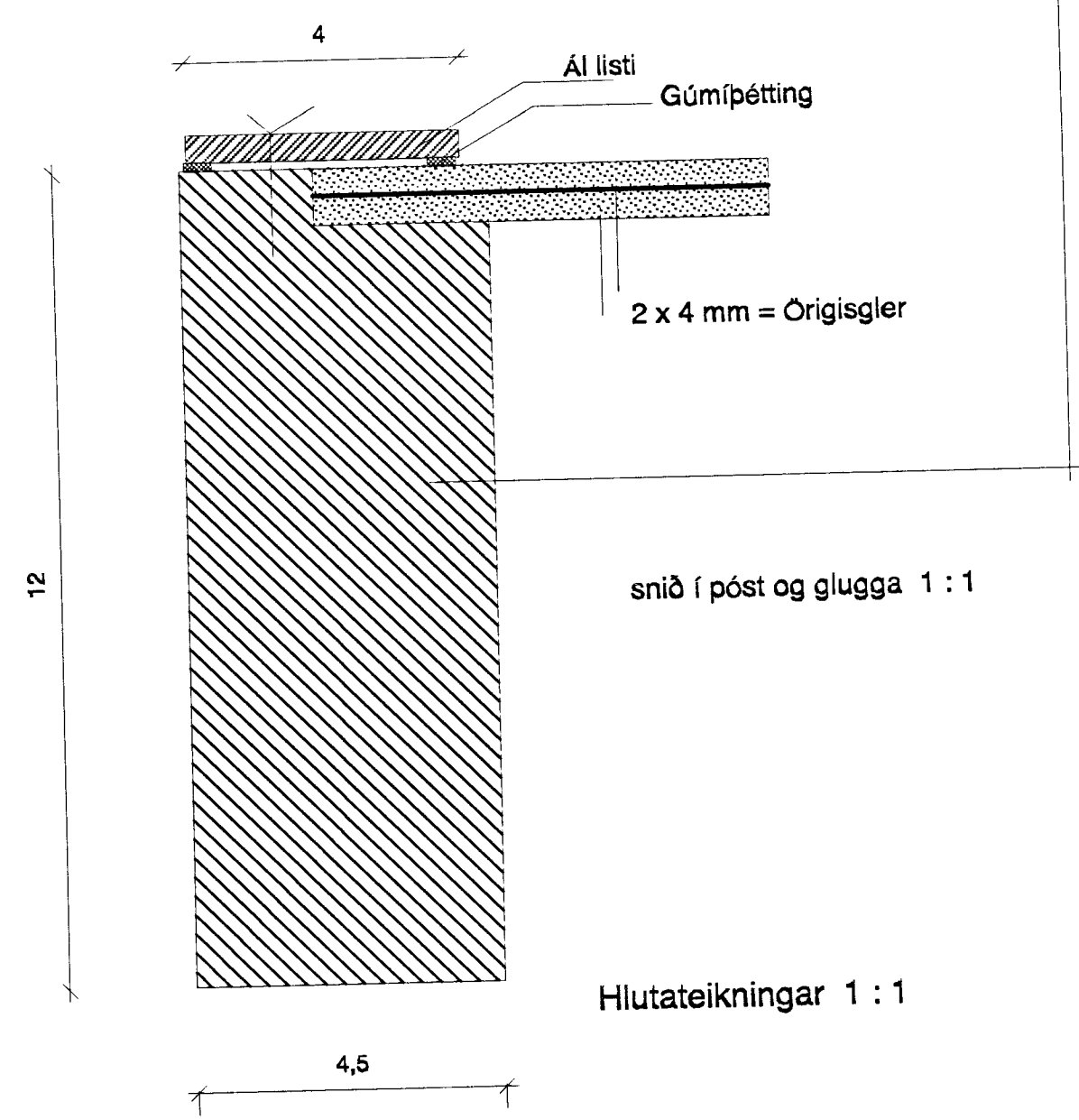
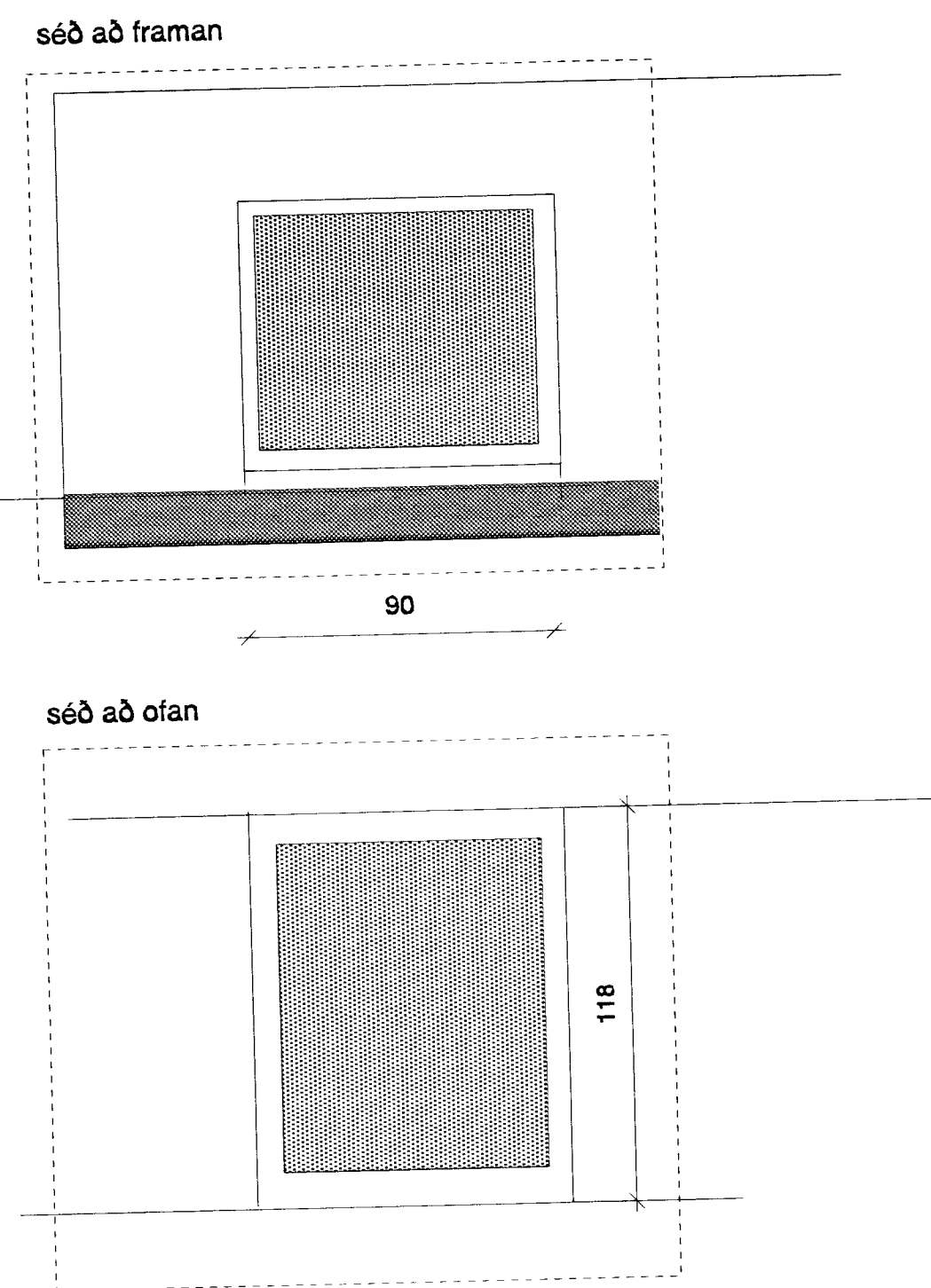

sniðmynd af grind 1 : 5

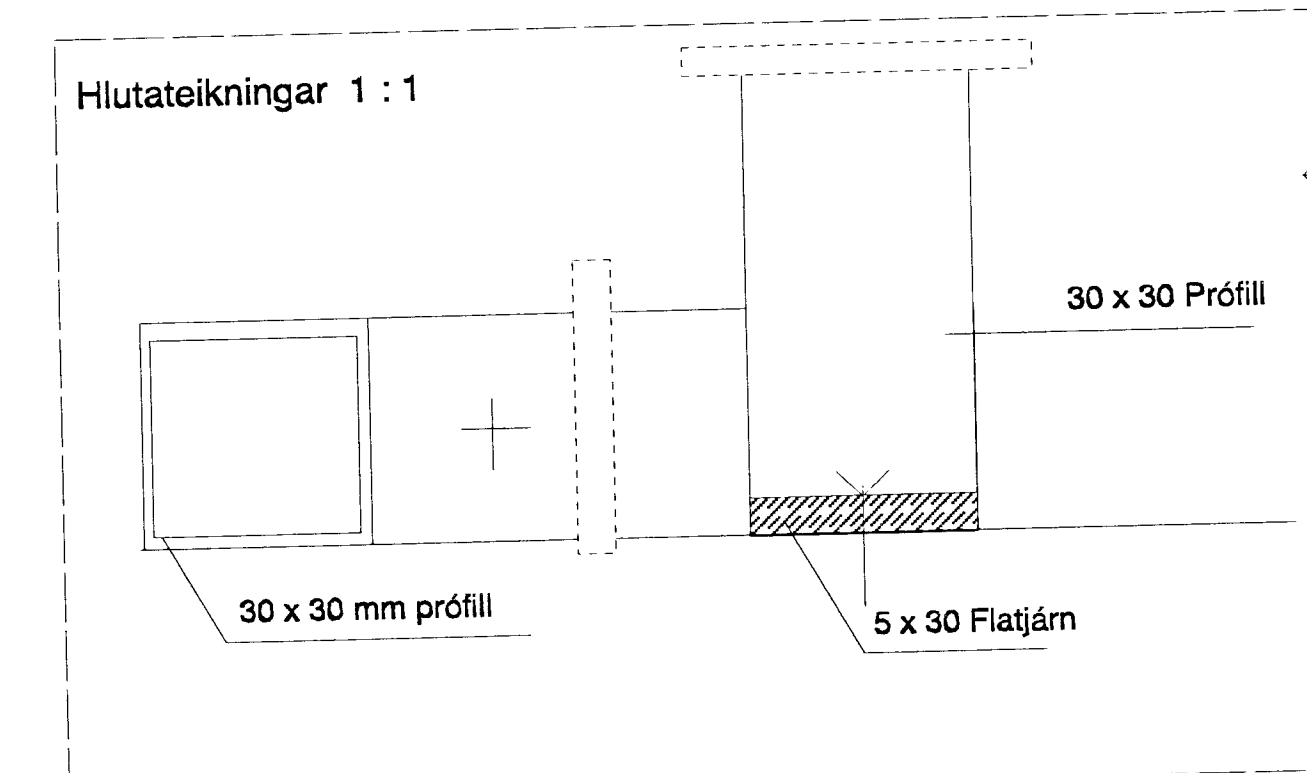
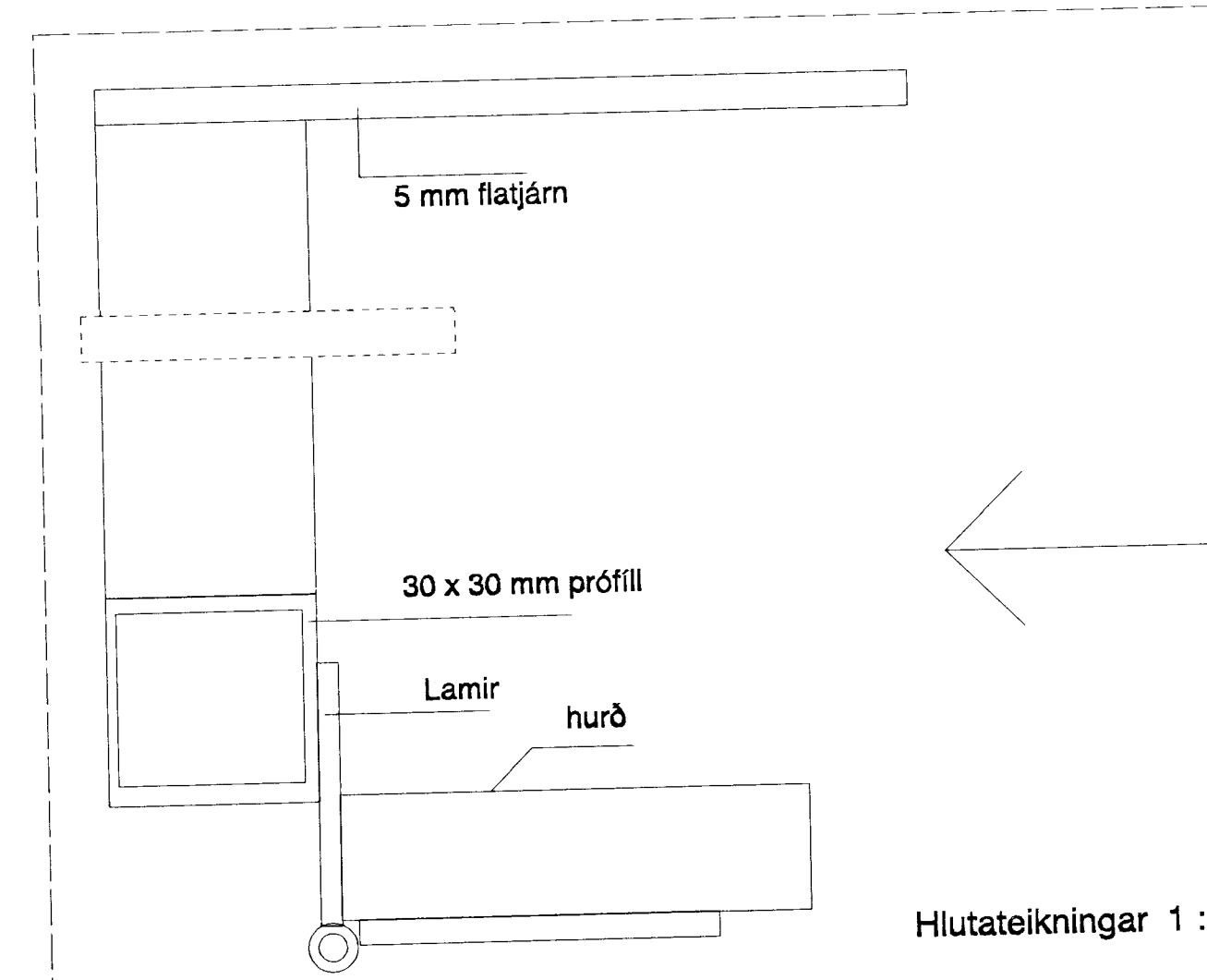
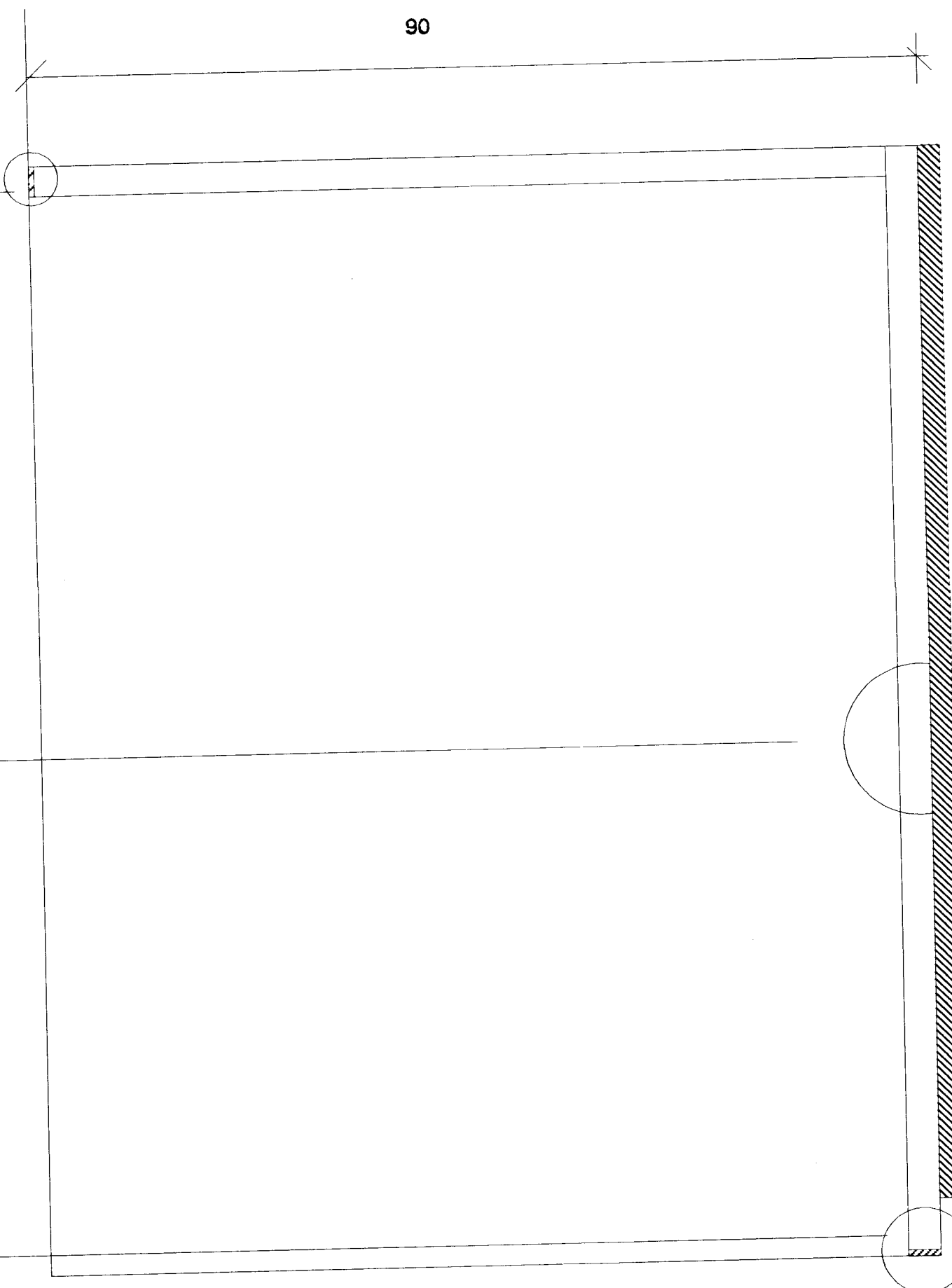

Snið í sorp geymslu

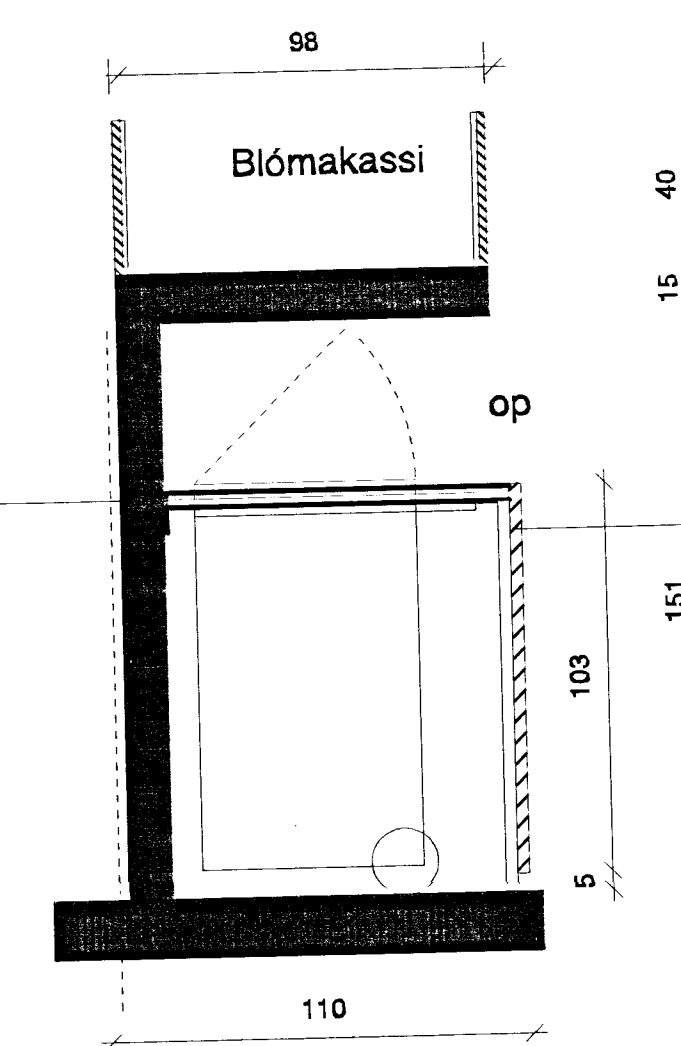

séð frama á sorpgeymslu

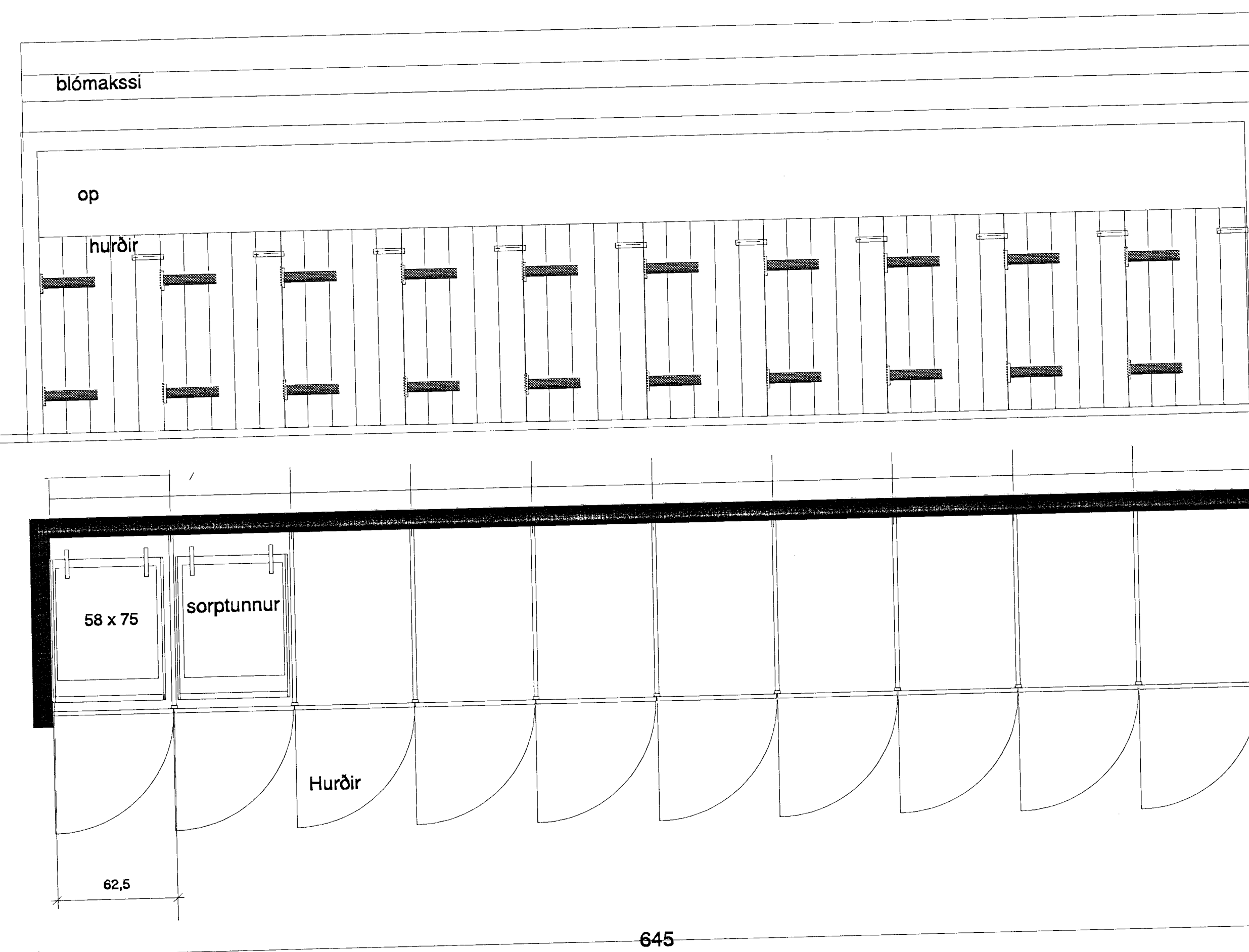

Skýringar  
Sorpgeymslur staðsteypt hölt fyrir tunnur sem hófað er niður með hurð að framan skilurúmmi er úr 30 x 30 próffilli sem sóðir eru á flatjárn sem skrúfast í botn og bak á sorpgeymslu

Sorptunnur 1 : 20

Höfundur	Hringbraut 4	Kvarði	1 : 5 1 : 20 1 : 1	nr.	1012
Verkefni	sorptunnur stígaús og stígaandri gluggi við geymslur	dagf.	20 - 6 - 99	teikn. nr.	V - 9
		hönnun	B E & T L	teikn.	B E

Hönnun  
Björn Einarsson & Trausti Leósson kt 310846 - 3769  
Innihússáskiltekt Byggingartæðingur  
587 - 8933 852 - 9029



Fransel Einarsson