

1 stk.  
nr.1

1 stk.  
nr.2

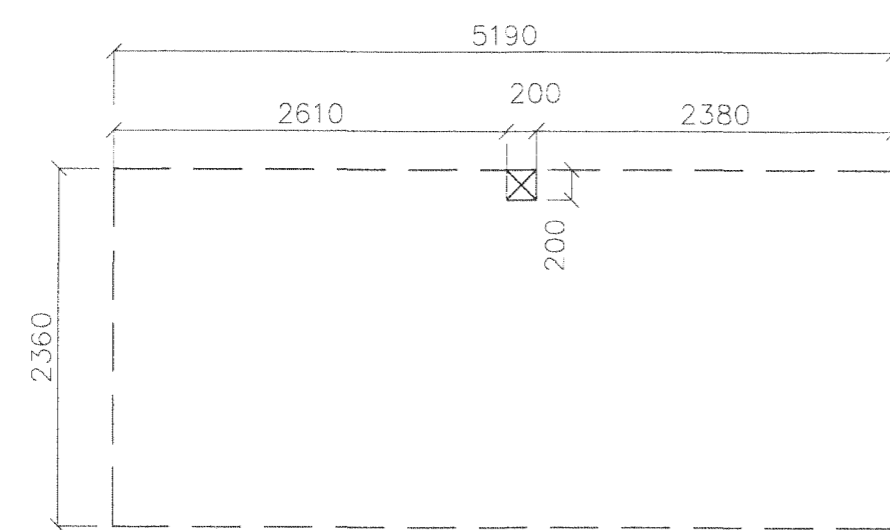

1 stk.  
nr.7

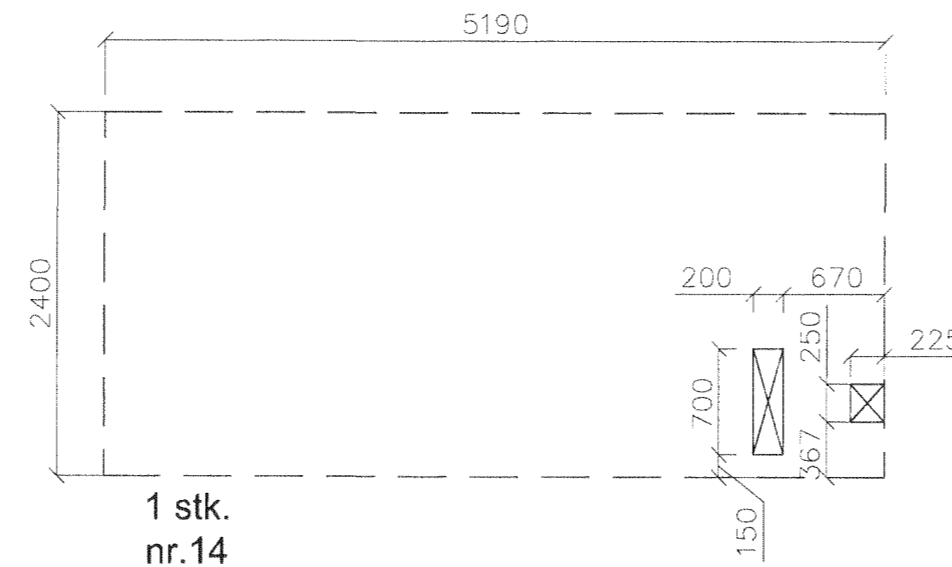

1 stk.  
nr.14

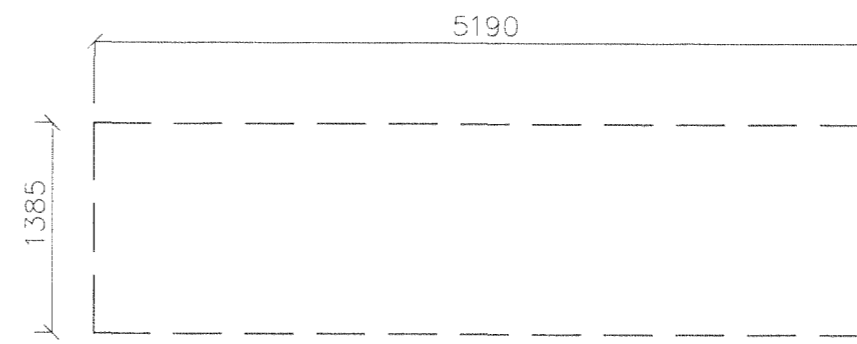

1 stk.  
nr.16

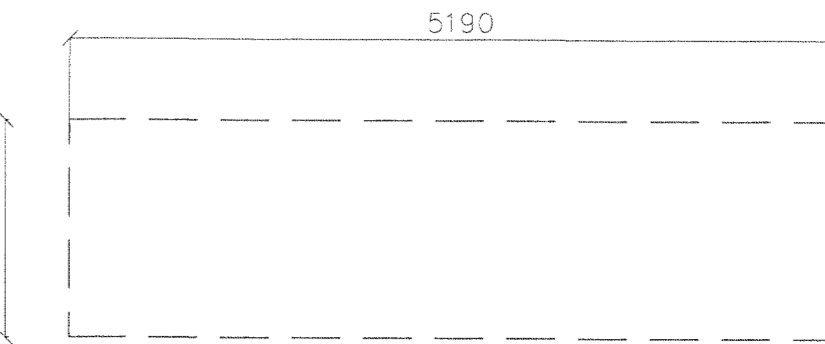

2 stk.  
nr.18-19

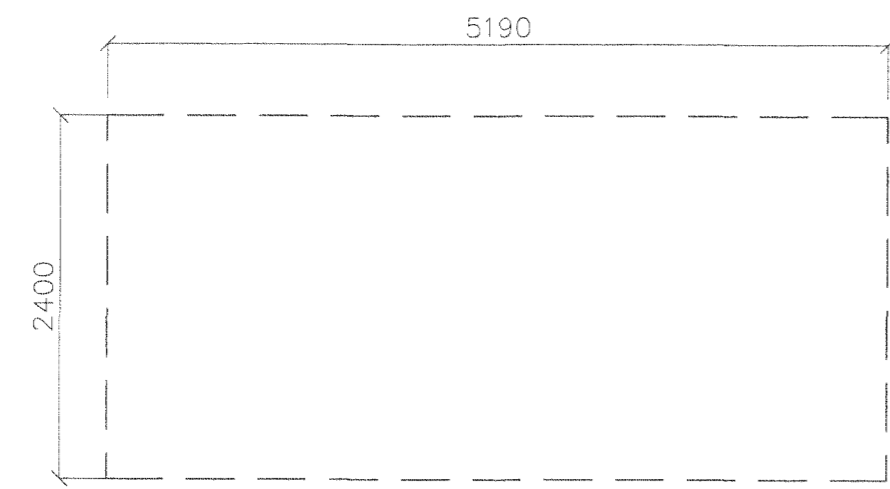

11 stk.  
nr.3-6,8-13,20

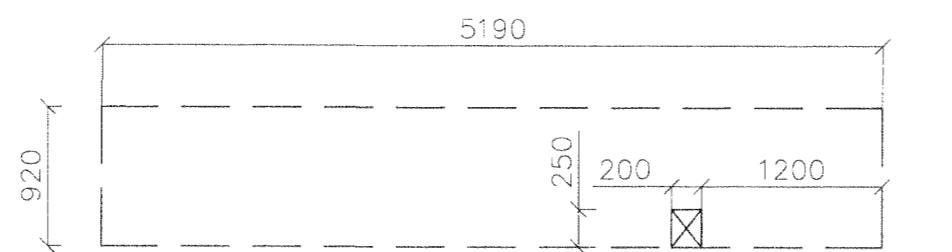

1 stk.  
nr.15

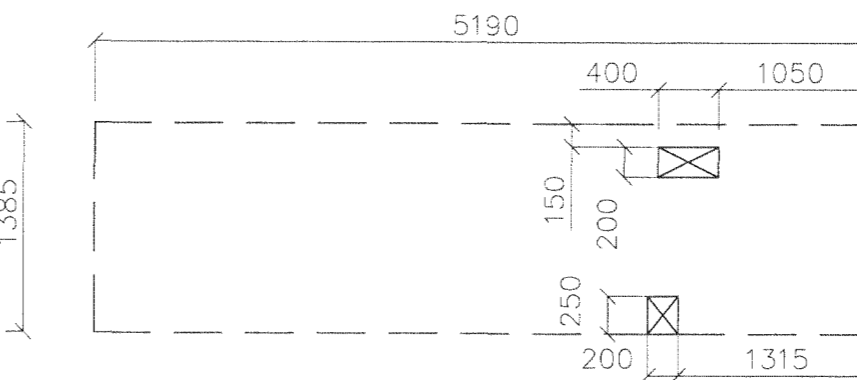

1 stk.  
nr.17

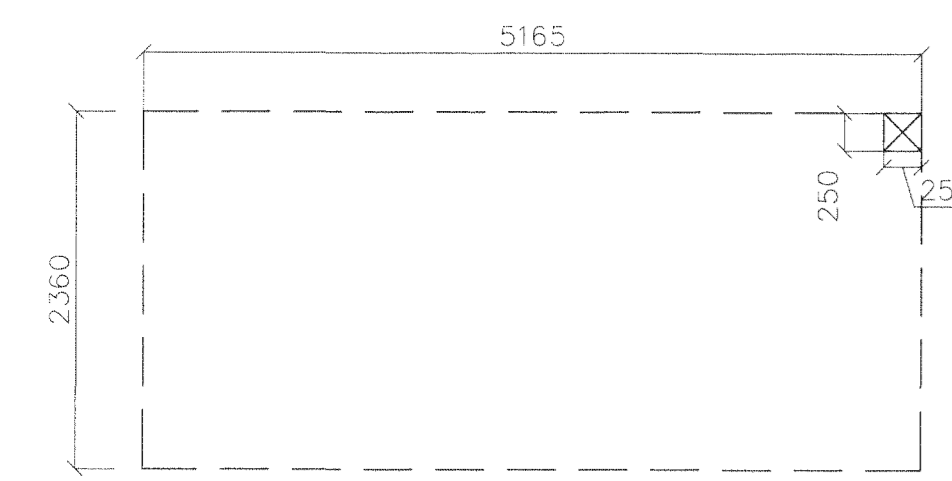

1 stk.  
nr.21

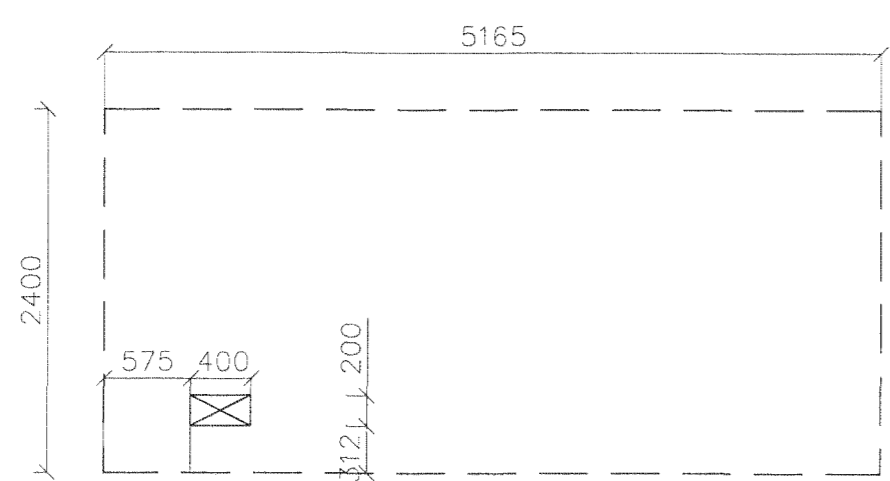

1 stk.  
nr.22

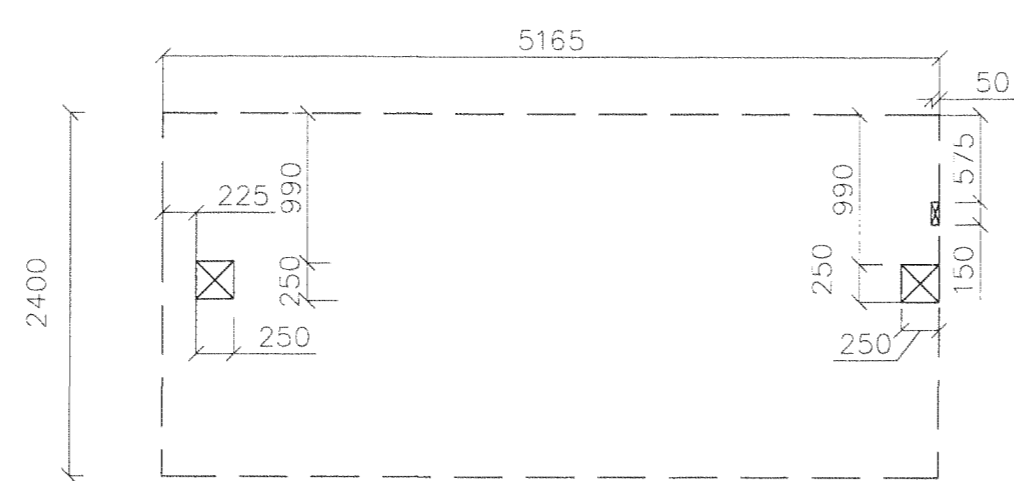

1 stk.  
nr.23

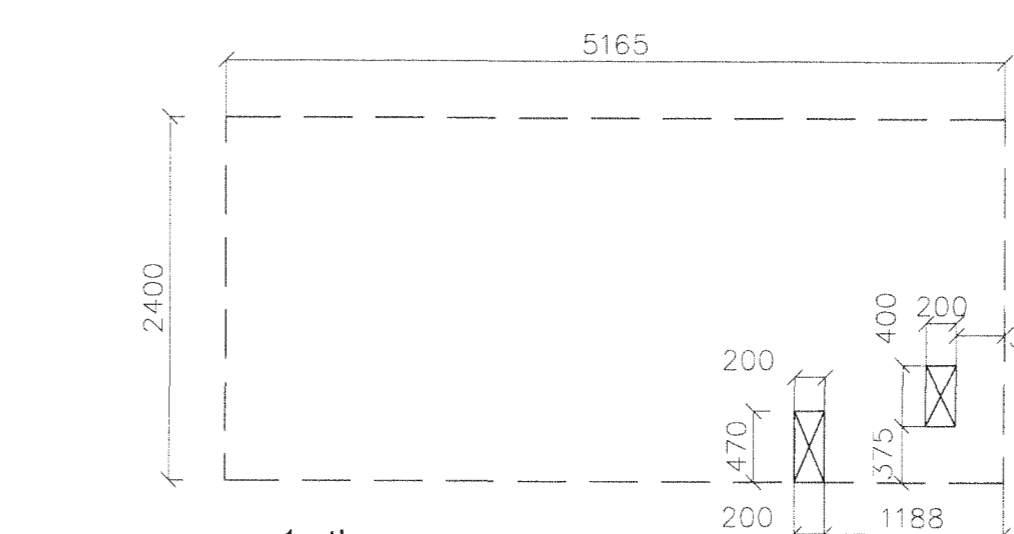

1 stk.  
nr.24

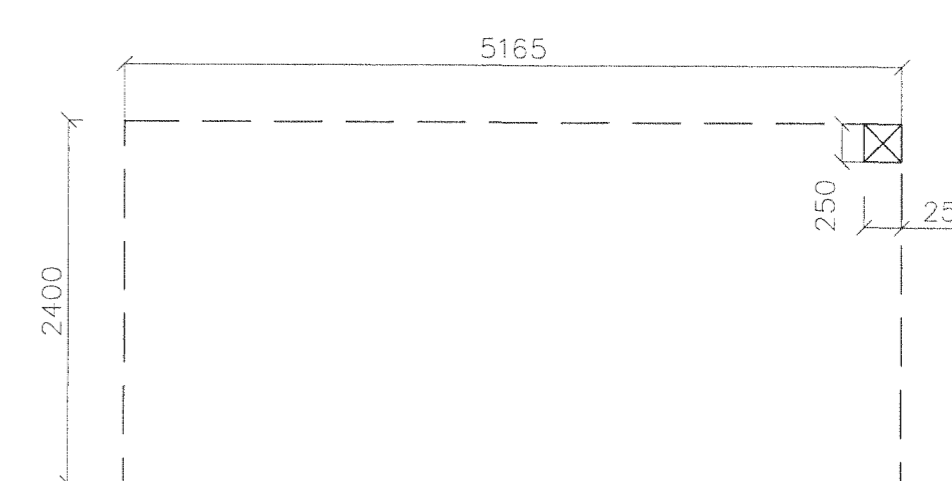

1 stk.  
nr.25

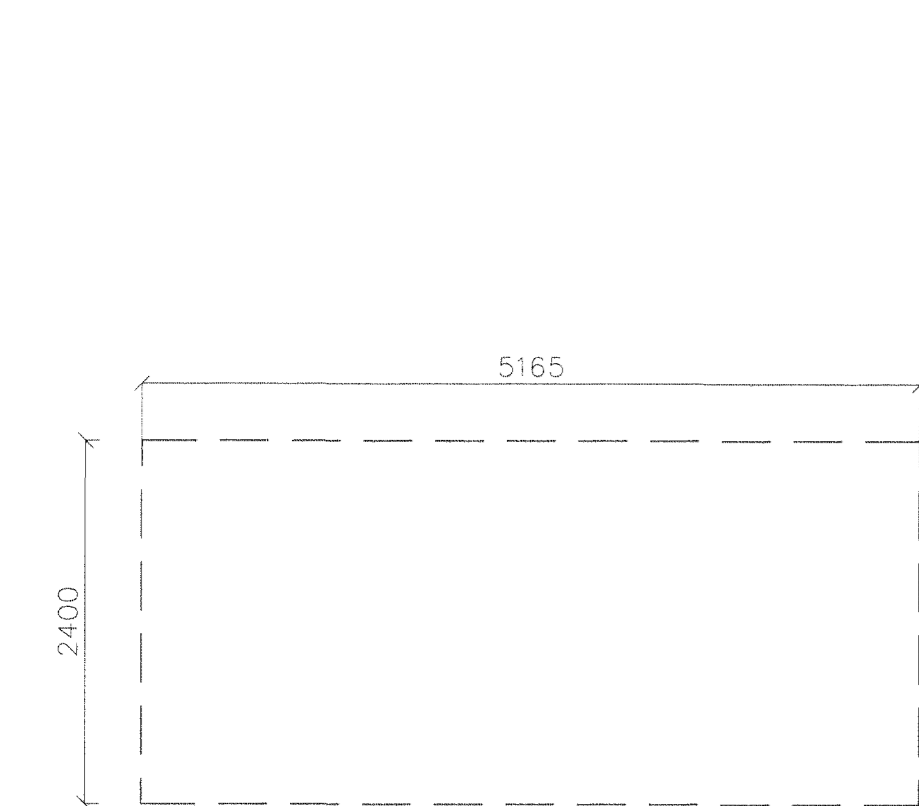

1 stk.  
nr.26

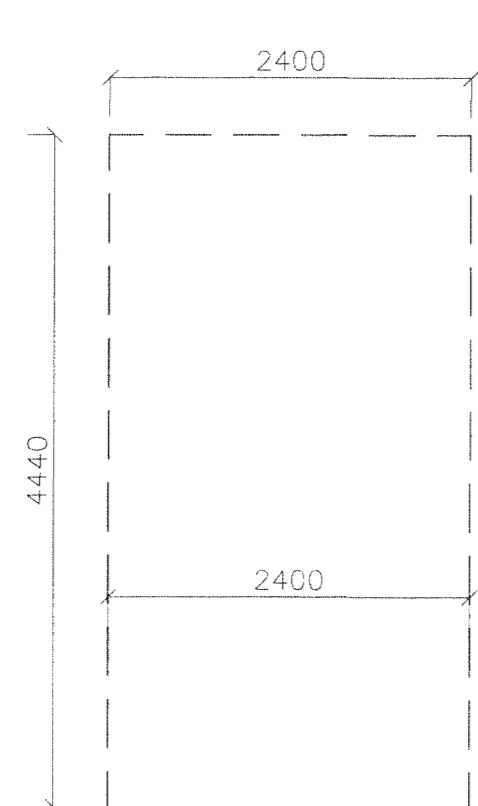

1 stk.  
nr.27

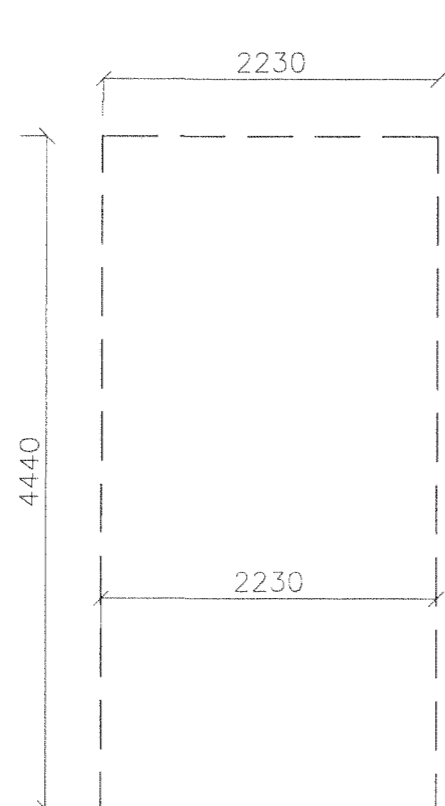

1 stk.  
nr.28

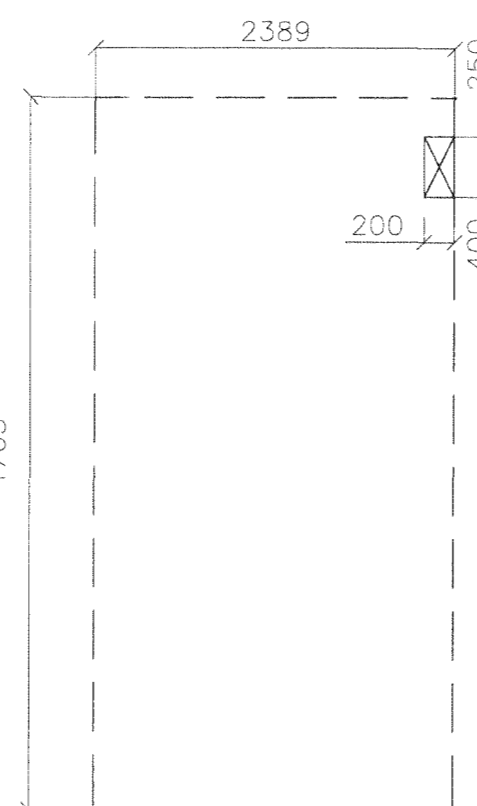

1 stk.  
nr.29

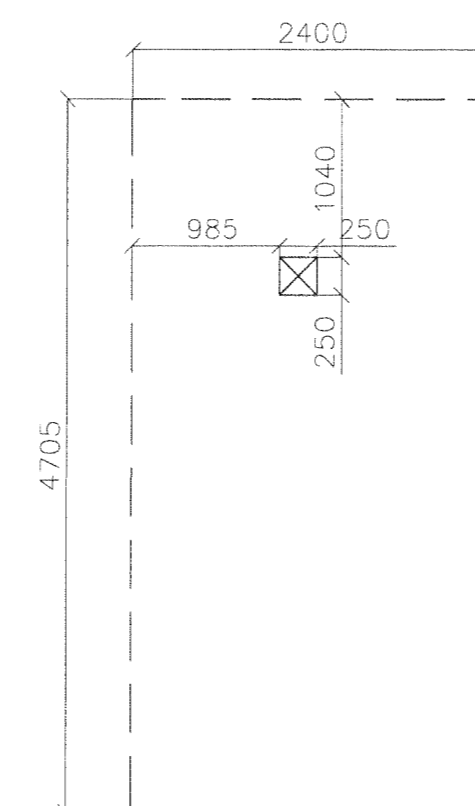

1 stk.  
nr.30

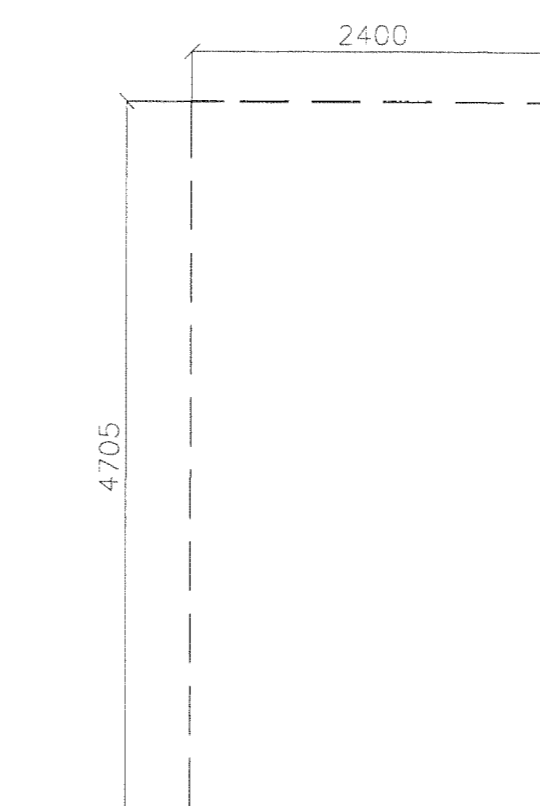

2 stk.  
nr.31,32

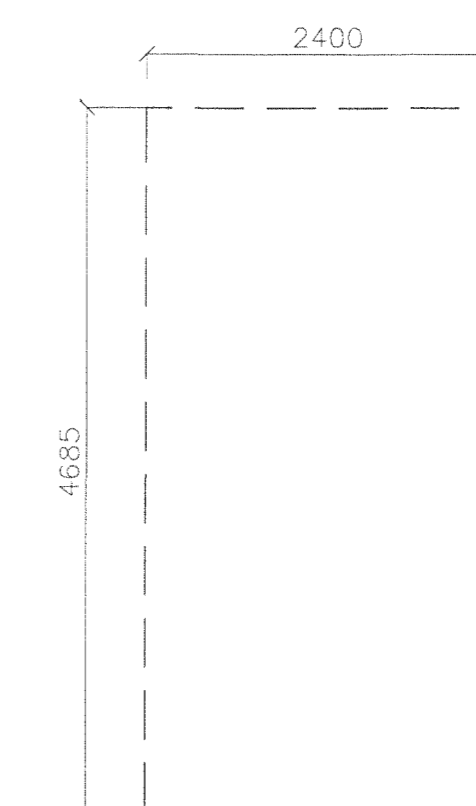

4 stk.  
nr.33-36

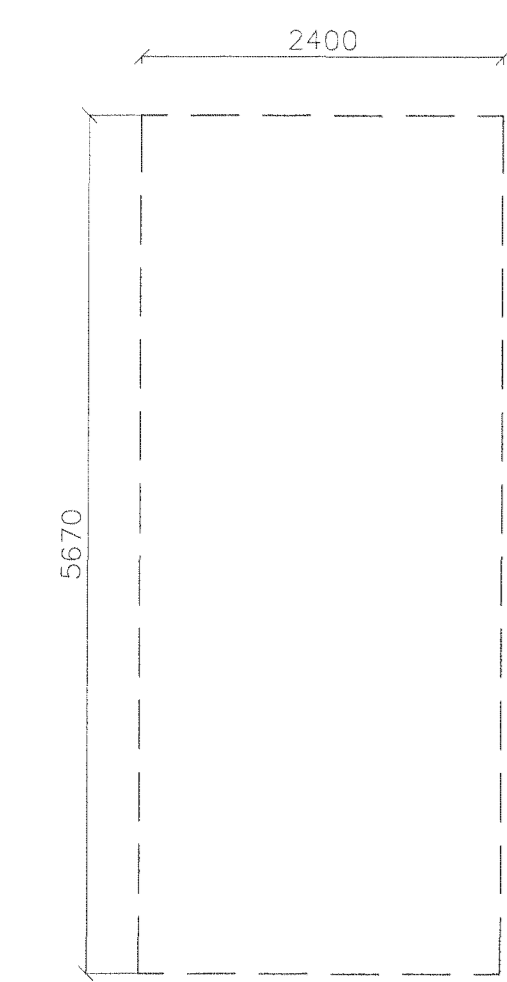

4 stk.  
nr.37-40

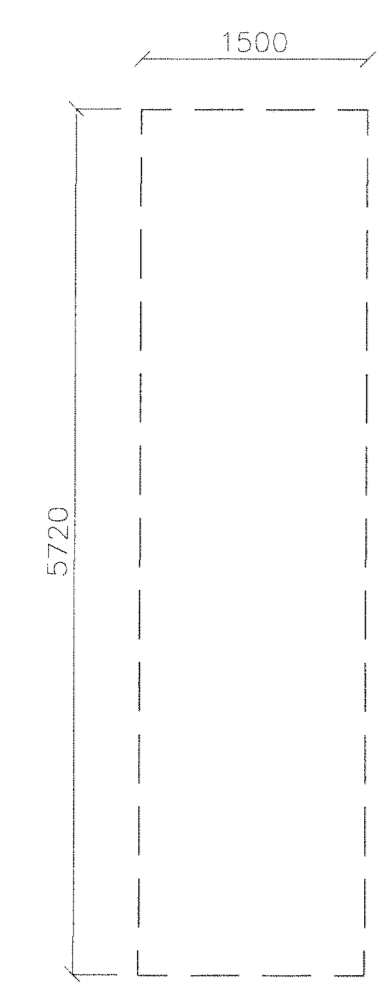

1 stk.  
nr.41

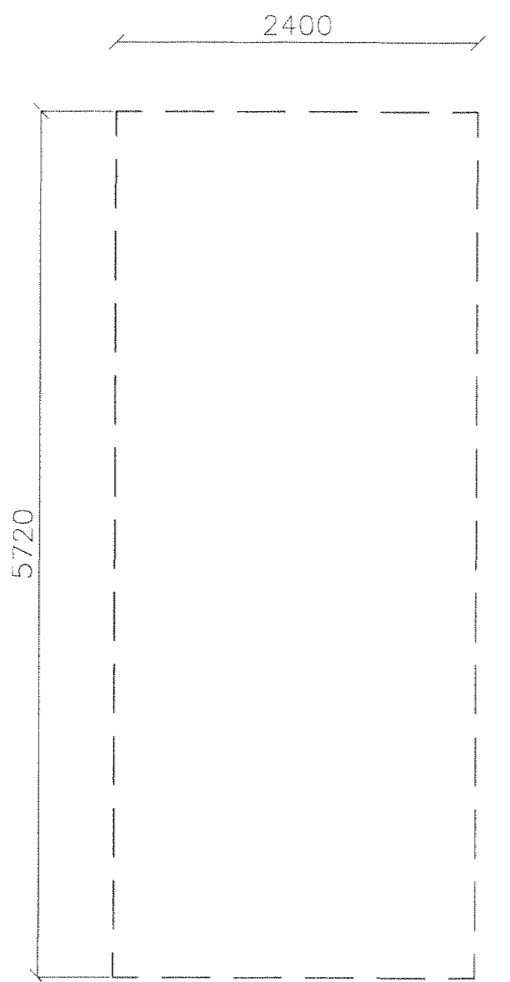

20 stk.  
nr.42-44,46,47,49-57,59-64

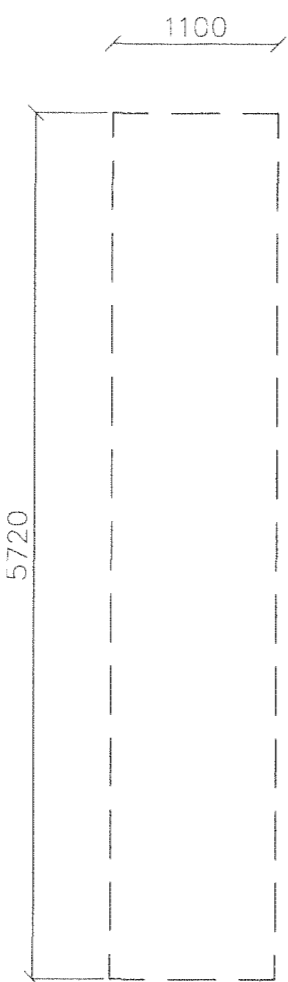

1 stk.  
nr.45

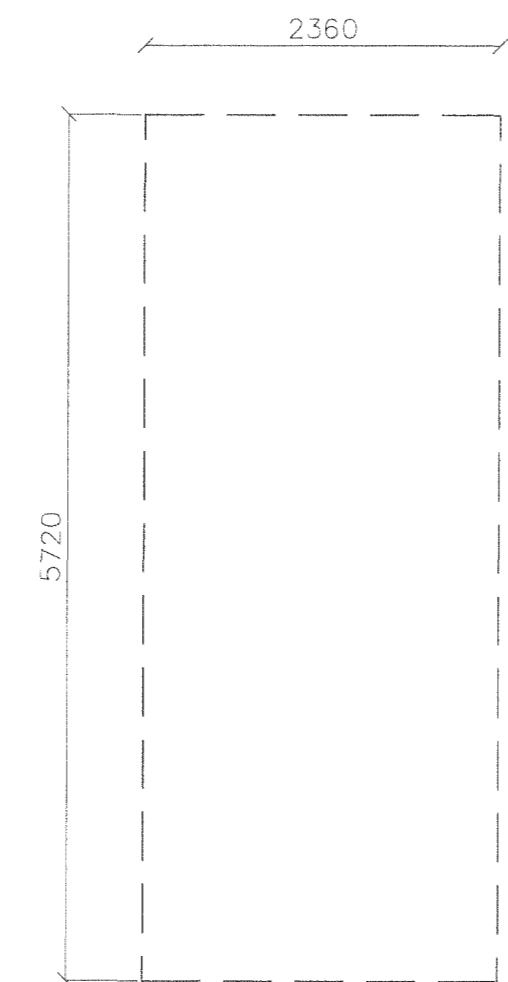

1 stk.  
nr.48

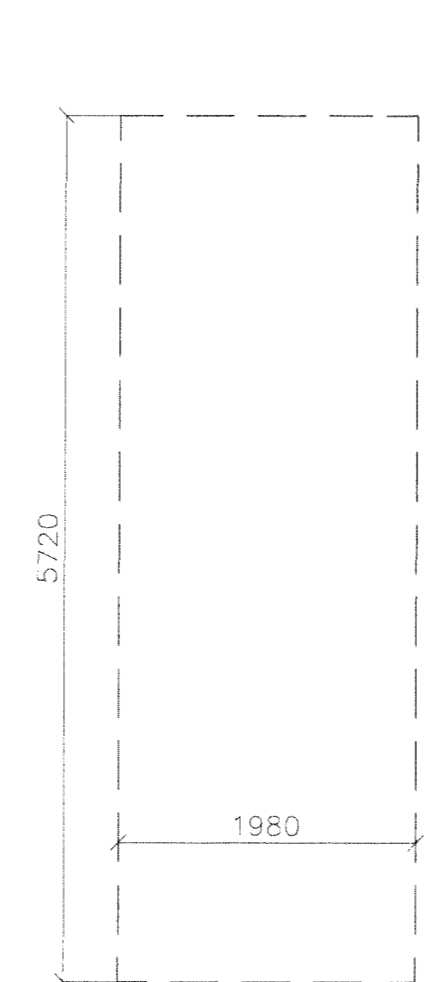

1 stk.  
nr.58

Samþykkt þann  
12 JAN 2011  
Byggingafulltrúinn í Hafnarfirði  
E.h. Hrólfur S. Gunnlaugsson

Skýringar

Heildarþykkt á plötu er 220mm

Jörnbending filigranplötna:

Plötur nr.1-2 er þendinet K189  
Plötur nr.3-36 er þendinet K189 og K10m220 í langgött plötu  
Plötur nr.37-64 er þendinet K189 og K10m100 í langgött plötu

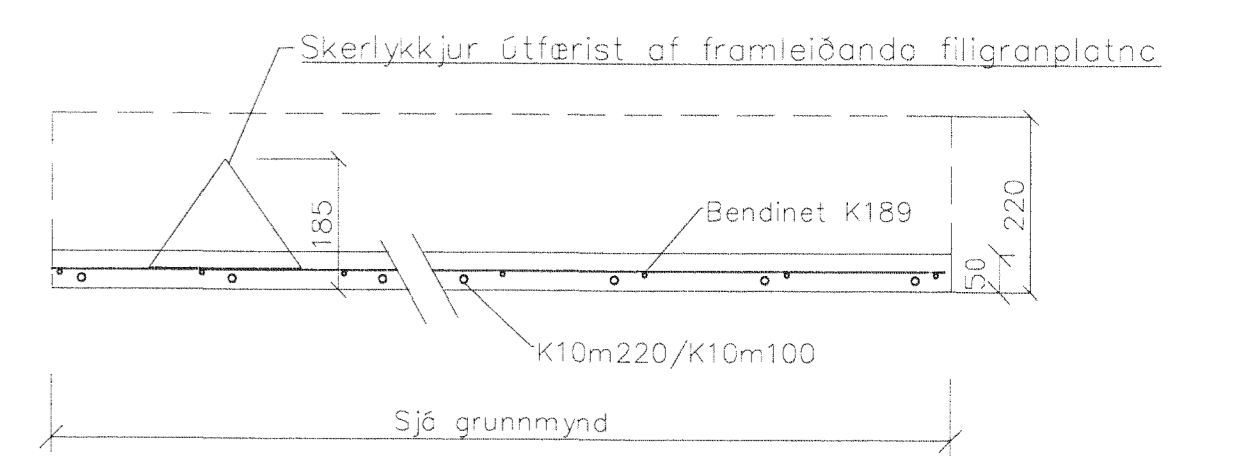

Horft í enda á samskeytum filigran plötna

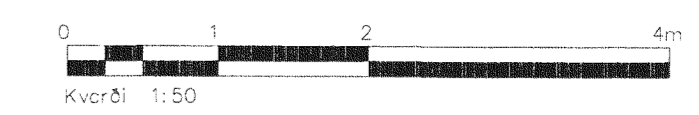

Glg.	Nr.	Breytingar	Hámaður	Daga
Verkteikning				

Hvaleyrarbraut 32, Hafnarfirði

Strendingur ehf. Verkfæðingusíða  
Fjarðargata 13-15 • 220 Hafnarfirður  
Sími 365 5646, Fax 365 5647 | strendingur@strendingur.is

Filigranplötur  
Smíðateikning

Daga: 26.11.2010  
Teynd / Mannab. JW/SG

Skemmtun: 1:50  
Síma teikning: 221