

URÐARSTÍGUR

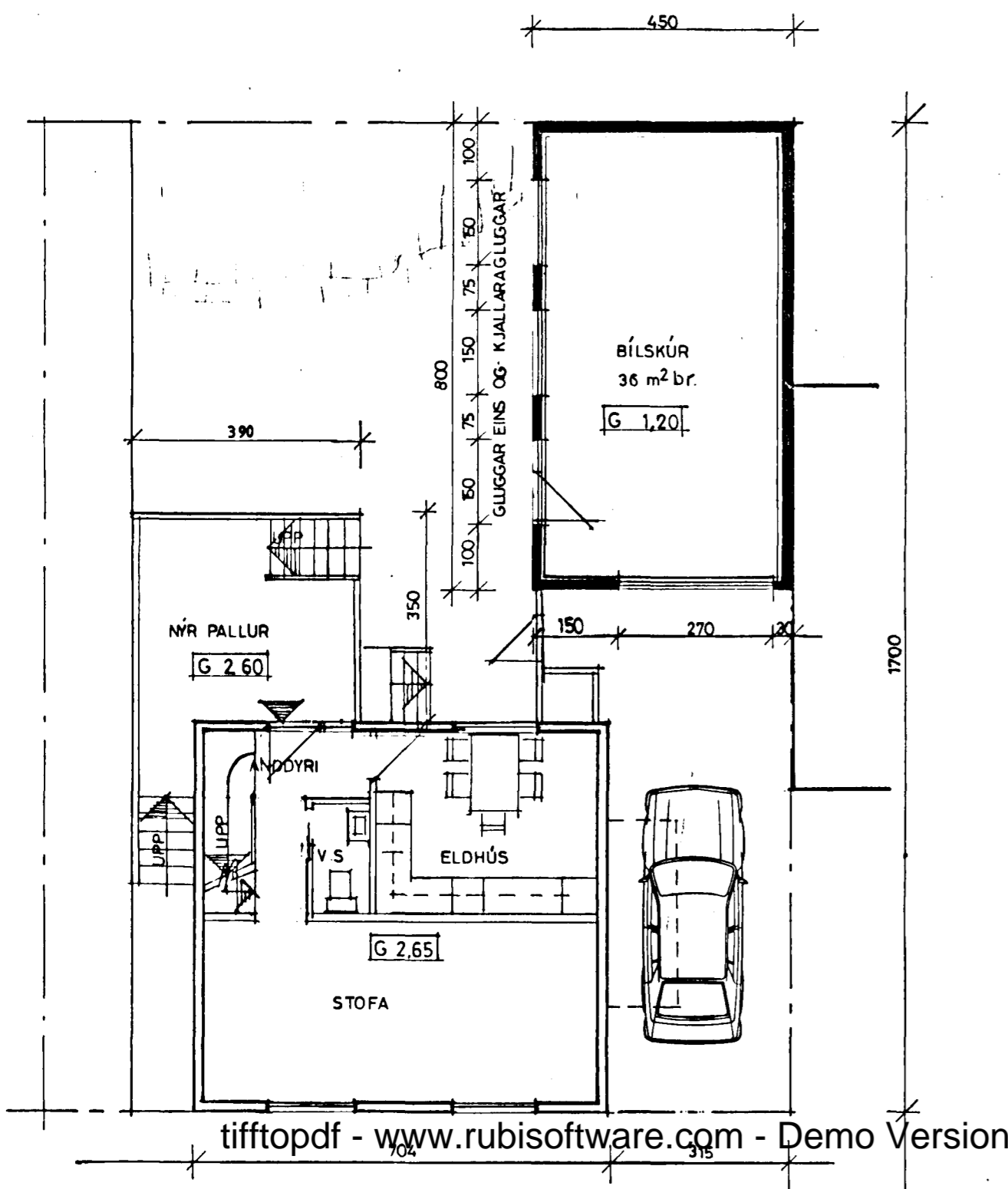

HVERFISGATA

GRUNNMYND HÚSS OG LÓÐAR 1:100

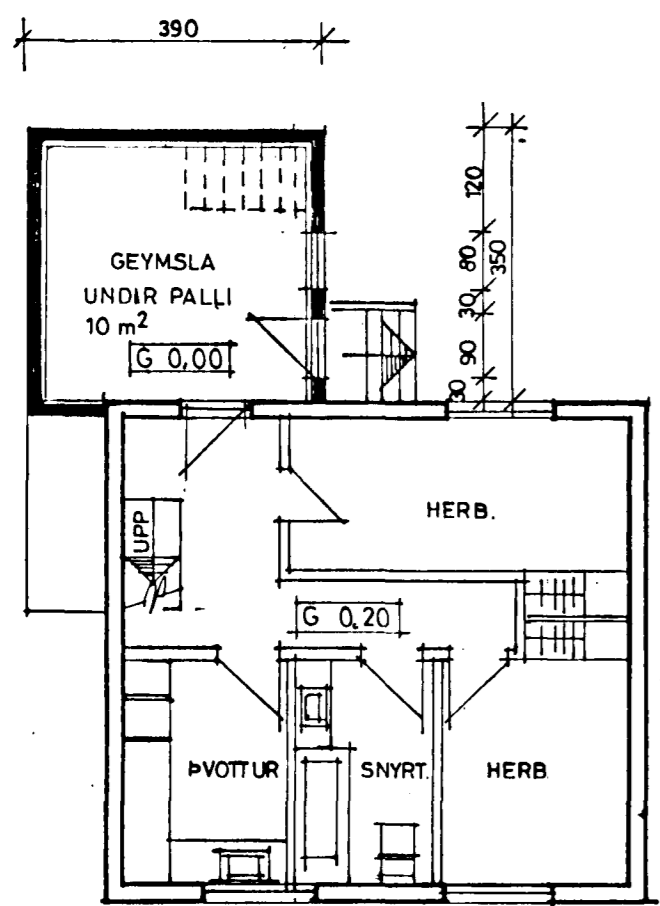

GRUNNMYND KJALLARA 1:100

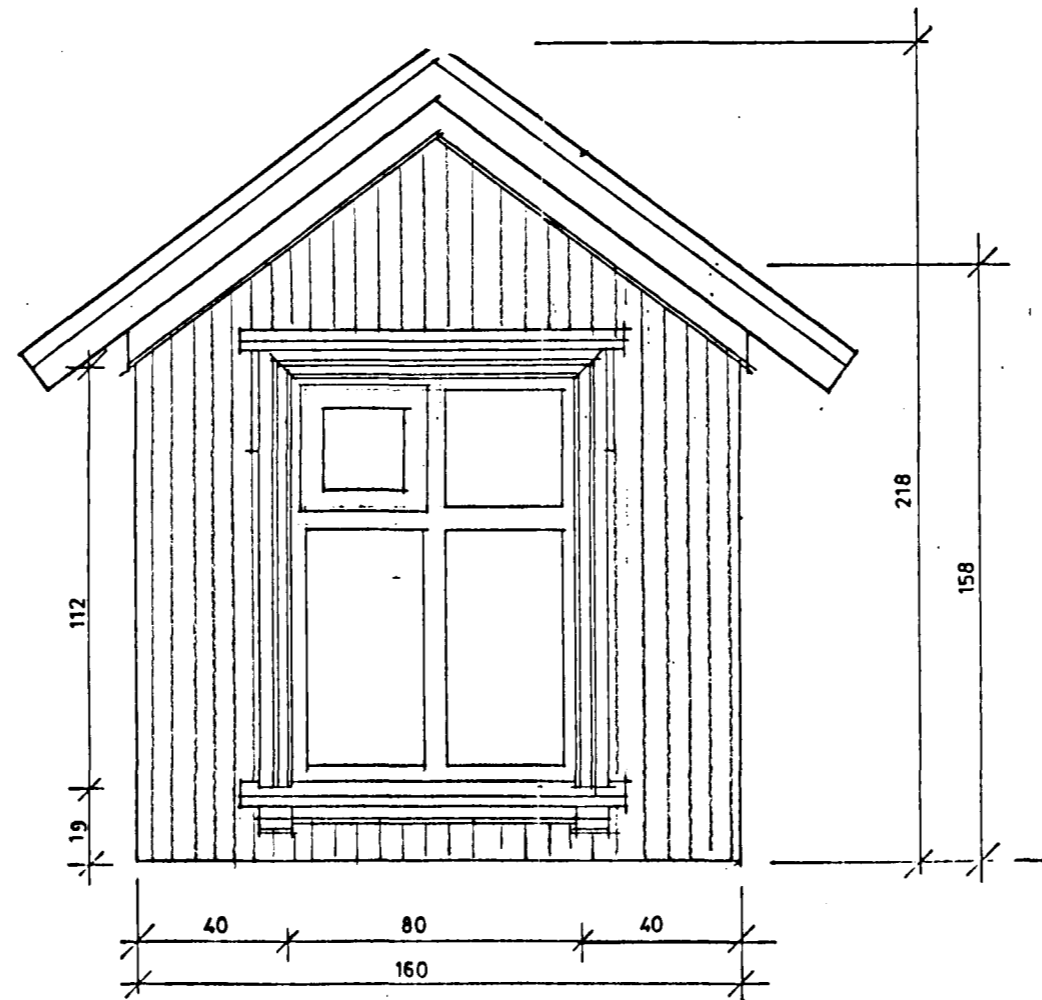

KVISTUR 1:20

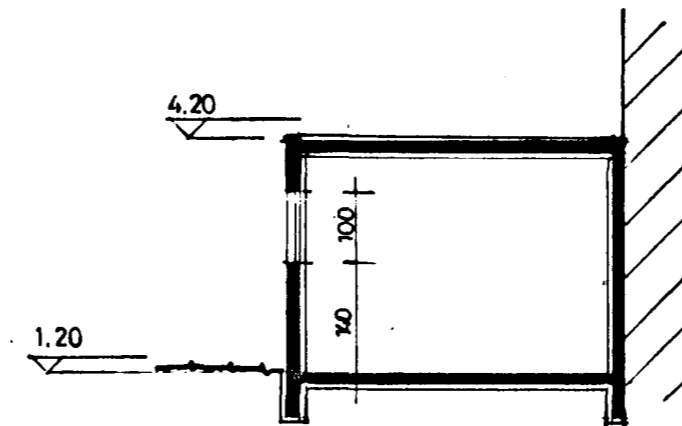

SNID Í BÍLSKÚR 1:100

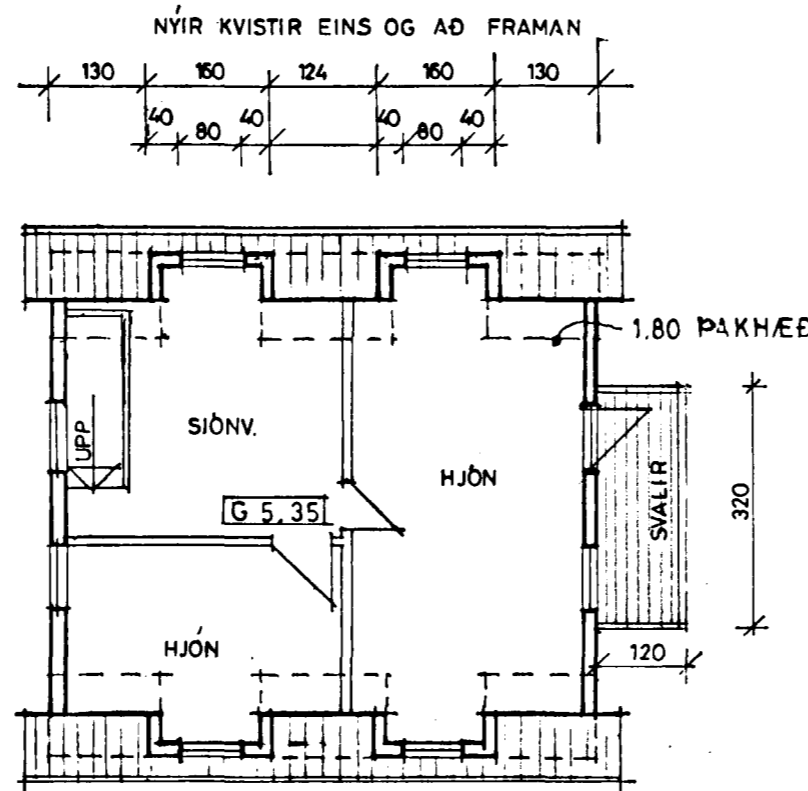

GRUNNMYND RISHÆÐAR 1:100

STÆKKUN:		
KVISTUR	3.2 m ²	2.9 m ³
GEYMSLA	12.2 "	31.7 "
BÍLSKÚR	36.0 "	110.0 "
ÁLLS:	51.4 m ²	144.6 m ³

ÖLL MÁL ATHUGIST Á STAÐNUM

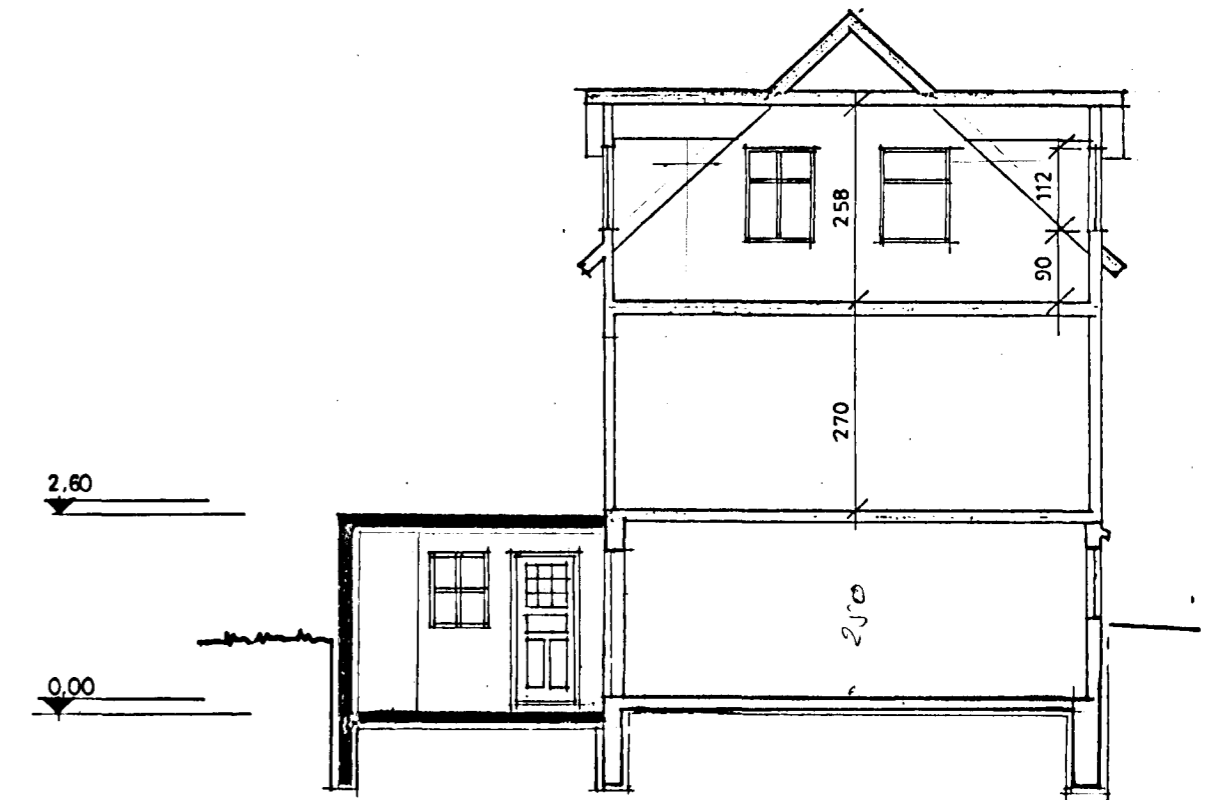

SNID 1:100

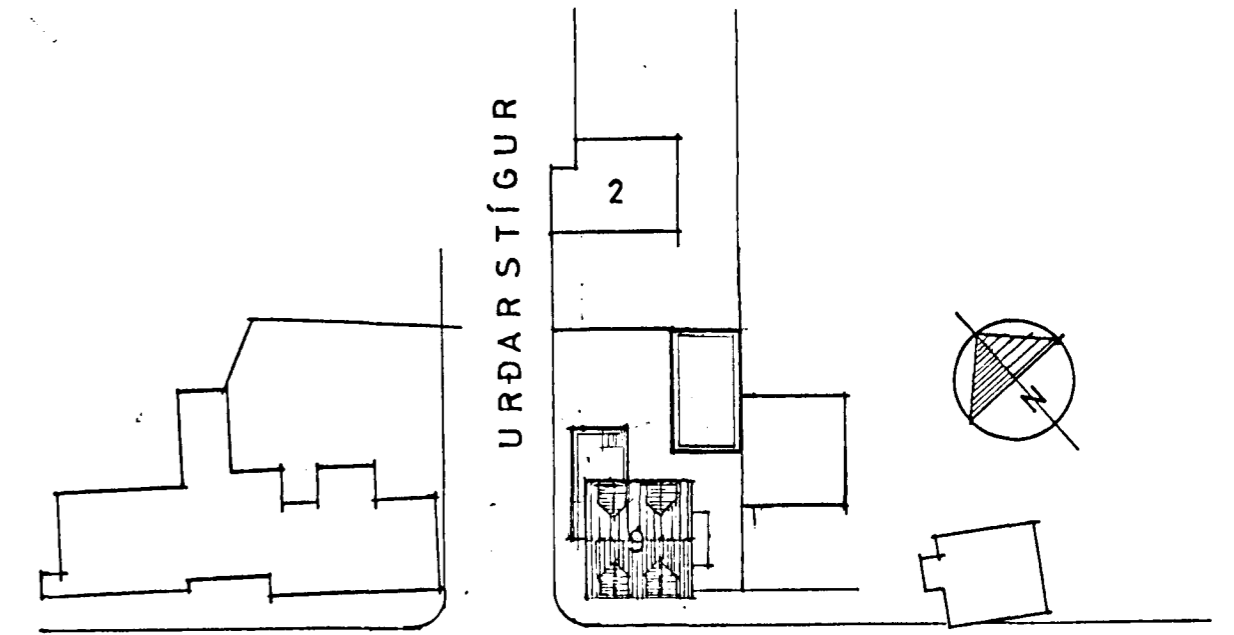

HVERFISGATA

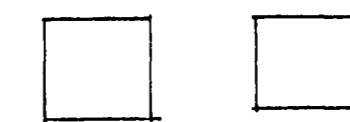

AFSTÖÐUMYND 1:500

BREYTT Í APRÍL 1989

TEIKNISTOFAN SUBURGÖTU 14 220 HAFNARFJÖRDUR
PÁLL V. BJARNASON ARKITEKT FAI SIMI 54355

53.03

HVERFISGATA 9, HAFNARFIRÐI VIÐBYGGING - BÍLSKÚR
GRUNNMYNDIR - SNID - AFSTÖÐUMYND

DAGS.	MARS 1988
KVARDI	1:100 - 1:500 - 1:20
HANNAÐ	P.V.B.
TEIKNAD	A.E.
YFIRF.	P.V.B.

Samþykkt á fundi bygginga-
nefndar þ. 17. 4. 19 91
BYGGINGAFULLTRÚINN
HAFNARFIRÐI
[Signature]

SKIKID: Fullnærfering í verð.
lotid fyrir 9. lok 1991