

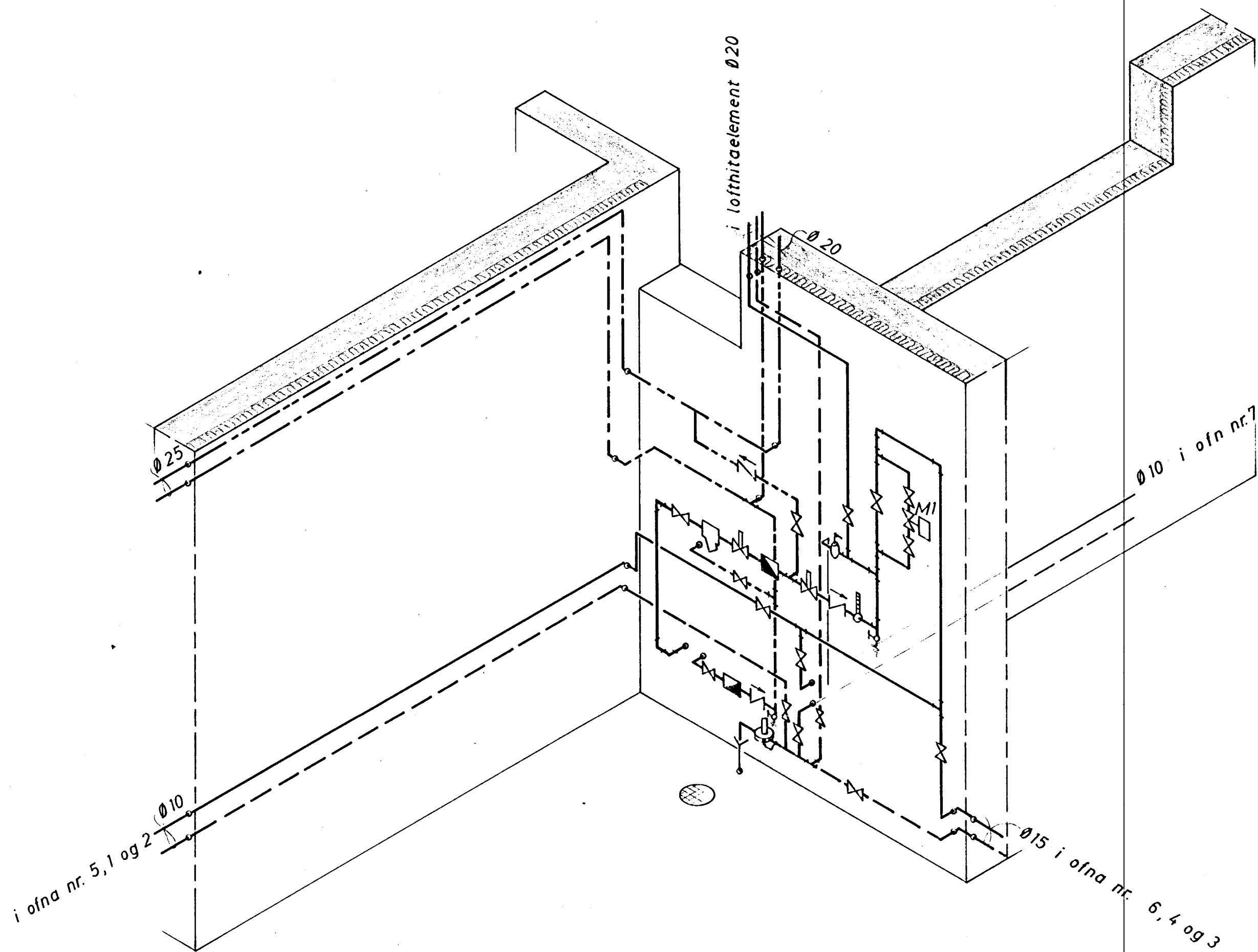









HAFNARFIJÐ  
14. júlí 1975  
E.S.

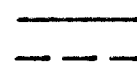
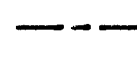
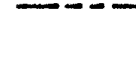

-  ÖRYGGISLOKI
-  MÓTORLOKI "M1", 1/2" GERÐ V 2045 + 5045 ( 13600 kcal/h )
- STÝRIST AF HERBERGISHITASTILLI T1 GERÐ T26A
-  VATNSMÆLIR
-  EINSTREYMISSLOKI
-  RENNILOKI
-  SLAUFULOKI GERÐ DANFOSS, AVD 15, TENGIST RA
-  AFTÆMIKRANI
-  TÜR HITAVEITU
-  RETÜR HITAVEITU
-  KALT NEYZLUVATN
-  HEITT NEYZLUVATN

Fj.	Heiti	Hl.nr.	Teikn.nr.	Efni	Aths.
Dags.	Leiðrétting	Dags.	Leiðrétting		
Breyting					
<b>VERKFRÆDISTOFA</b> <b>GUDMUNDAR &amp; KRISTJÁNS</b> Laufásvegji 19 Sími 14425				Mkv.	Verkf. 7,75 6.22
				Teikn.	7,75 B.G.
				Yfirf.	
				Samp.	
JÓFRÍÐARSTAÐAVEGUR 11. TENGIKLEFI HITAVEITUTENGINGAR				Dagbók nr.	TEIKNING NR.
					<b>2M-1-98</b>
				Verk nr.	blað af